

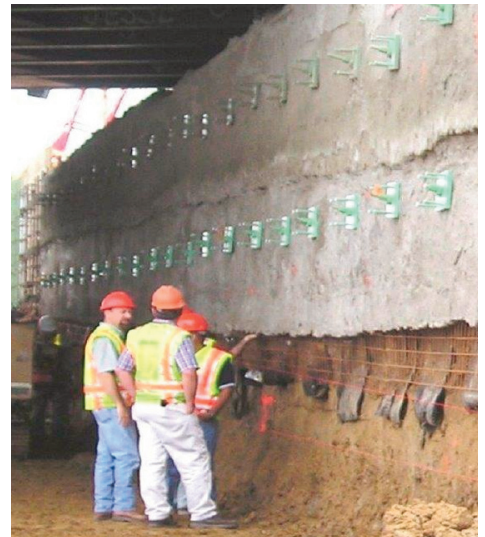

State of Illinois
Illinois Department of Transportation



Geotechnical

Manual



Illinois Department
of Transportation

GEOTECHNICAL MANUAL

Prepared and Published by
Illinois Department of Transportation
Office of Highways Project Implementation
Bureau of Materials

Springfield, Illinois
December 15, 2015
Revised December 4, 2020

This page left intentionally blank.



Illinois Department of Transportation Departmental Policy

MAT-14 : GEOTECHNICAL MANUAL

Effective Date: January 2nd, 2018
Scheduled January 2nd, 2022
Approved By: Paul Loete, Priscilla Tobias
Version: 3.0

1. POLICY

It is the policy of the Illinois Department of Transportation (IDOT) to publish and maintain a manual that establishes geotechnical policies consistent with the [Standard Specifications for Road and Bridge Construction](#) and provides uniform procedures for geotechnical practices.

2. PERSONS AFFECTED

This policy affects the Office of Highways Project Implementation and Office of Planning and Programming.

3. PURPOSE

The purpose of this policy is to provide for the publication of a manual that contains a compilation of policies and guidelines which will define the Illinois Department of Transportation's geotechnical practices relative to achieving maximum production and quality performance in highway projects and promote uniformity in geotechnical practices.

4. GUIDELINES FOR IMPLEMENTATION

The policies and guidelines which constitute the [Geotechnical Manual](#) are effective on the date noted on the material itself. The manual covers subject areas such as:

- A. Clarification of corresponding sections of the [Standard Specifications for Road and Bridge Construction](#)
- B. Geotechnical investigations,
- C. Geotechnical analyses,
- D. Design recommendations,
- E. Geotechnical reports,
- F. Geotechnical engineering for construction,
- G. Geology and pedology, and
- H. Laboratory and field testing of soils.

5. RESPONSIBILITIES

The following outlines the individual and office responsibilities to ensure compliance with the provisions of this policy and its appendixes:

- A. The **Central Bureau of Materials** (CBM) is responsible for the issuance and maintenance of this policy and the associated manual or procedures.
- B. The **Office of Highways Project Implementation’s regions/districts** and the **Office of Program Development** are responsible for ensuring compliance with this policy.
- C. The **Geotechnical Engineer** of the CBM Concrete, Soils & Metals Section should be contacted when questions arise regarding the application of these procedures.

6. REVISION HISTORY

This policy includes the following changes:

- This policy was deemed current and adequate for continued use.

Archive versions of this policy are available by contacting the Document Services Unit in the Bureau of Business Services at DOT.Policy@illinois.gov.

7. CLOSING NOTICE

Supersedes: Departmental Policy MAT-14: Geotechnical Manual,
Effective October 7, 2013

Attachment(s): [Geotechnical Manual](#)

PREFACE

The *Geotechnical Manual* (the Manual) has been prepared to provide uniform procedures for geotechnical practices for the Department, local public agencies, and consultant firms in performing geotechnical studies, preparing reports, and conducting construction materials inspections of projects for and/or under the oversight of the Department. This manual supersedes the January 1999 version of the *Geotechnical Manual* published by [IDOT \(1999\)](#). The Manual presents the information normally required in the development of a typical geotechnical project. The designer should meet all applicable criteria and practices presented in the Manual. However, the Manual cannot address all potential situations and should not be considered a standard that shall be met regardless of impacts. The designer should develop geotechnical components of the roadway designs that meet IDOT's operational and safety requirements while preserving the aesthetic, historic, and/or cultural resources of an area. Designers shall exercise sound engineering judgment on individual projects and, occasionally, be innovative in the approach to the design. This may entail, for example, additional research into highway and geotechnical literature.

The Bureau of Bridges and Structures and the Central Bureau of Materials developed the *Geotechnical Manual*. Special acknowledgements are also given to the engineering consulting firms of WHKS & Co. and McCleary Engineering for their assistance in developing the initial framework of the Manual.

IDOT MISSION STATEMENT

We will provide safe, cost-effective transportation for Illinois in ways that enhance quality of life, promote economic prosperity and demonstrate respect for our environment.

GUIDING PRINCIPLES

We will accomplish our mission while making the following principles the hallmark of all our work:

- Safety
- Integrity
- Diversity
- Responsiveness
- Quality
- Innovation

This page left intentionally blank.

DOCUMENT CONTROL AND REVISION HISTORY

The *Geotechnical Manual* is reviewed during use for adequacy and updated as necessary by the Central Bureau of Materials. The approval process for changes to this manual is conducted in accordance with the procedures outlined in the Illinois Department of Transportation's Document Management Manual.

Electronic

Portable Document Format (PDF) has been selected as the primary distribution format. The official version of the manual is available on the Illinois Department of Transportation website and the Policy and Research Center Library site on InsideIDOT.

Hard Copy

This manual is no longer distributed in hard copy format. Users who choose to print a copy of the manual are responsible for ensuring use of the most current version.

Archived Copies

Archived versions of this manual are available to examine by contacting the Policy and Research Center at DOT.PolicyResearchCenter@illinois.gov.

<u>Date</u>	<u>Revision Date</u>	Description of Change	Authorized By
12/15/15		Original edition.	Heather Shoup
	12/4/20	Revised to reflect Department organizational changes, updated Abbreviations and Description, deleted Table 3.2.2.4-1 due to outdated website links, updated Section 4.2, added clarification for determining RQD in Section 4.4.6.2.2, added SPT hammer energy measurement reporting in Section 4.4.7.1.2, added Section 5.5.15 on Relative Density Testing, revised and expanded Sections 6.13 and 8.10 for driven piles, updated Section 7.4.2 SGR submittal and review process, added references to Design Guides in Sections 6.8.2.4 and 6.13.3, updated external hyperlinks, and made various minor editorial corrections.	Heather Shoup

This page left intentionally blank.

TABLE OF CONTENTS

Policy MAT-14 i

Preface.....iii

Document Control and Revision History..... v

Manual Commentsvii

Table of Contents.....ix

List of Figures and Tables.....27

Abbreviations and Descriptionsxxxiii

Chapter 1 General, Organization and Administration 1-1

1.1 General 1-1

1.2 State Geotechnical Organization and Responsibilities 1-1

1.3 Geotechnical Engineering Consultant Firm Usage 1-6

1.4 Other Geotechnical Resources Documents..... 1-7

Chapter 2 Geotechnical Studies Overview 2-1

2.1 Introduction..... 2-1

2.2 Geotechnical Engineering Tasks in Planning, Design, and Construction

Phases 2-1

2.2.1 Planning and Design Phases.....2-1

2.2.2 Construction Phase2-3

2.3 Types of Studies 2-3

2.3.1 Corridor and Feasibility Geotechnical Studies2-4

2.3.2 Design Phase Geotechnical Studies.....2-4

2.3.2.1 Roadways..... 2-5

2.3.2.2 Structures 2-5

2.3.3 Special Investigations.....2-5

2.4 Project Development Process..... 2-6

Chapter 3 Reconnaissance and Project Scoping..... 3-1

3.1 Introduction..... 3-1

3.2 Reconnaissance of Project Area..... 3-1

3.2.1 Proposed Project Improvement Information.....3-2

3.2.2 Literature Review	3-2
3.2.2.1 Aerial Photography	3-3
3.2.2.2 Topographic and LiDAR Maps	3-3
3.2.2.3 Geology and Pedology	3-4
3.2.2.3.1 ISGS Information	3-5
3.2.2.3.2 USDA/NRCS County Soil Survey Reports	3-5
3.2.2.4 Climatological Data	3-6
3.2.3 Departmental Records	3-7
3.2.3.1 Existing Plans	3-7
3.2.3.1.1 Existing Structure Plans	3-8
3.2.3.1.2 Existing Roadway Plans	3-8
3.2.3.2 Existing Borings, Test Data, and Geotechnical Reports	3-9
3.2.3.3 Existing Hydraulic and Bridge Inspection Records	3-9
3.2.3.4 Existing Pile Driving Data	3-9
3.2.4 Field Reconnaissance	3-10
3.3 Project Scoping	3-11
3.3.1 Scoping Corridor and Preliminary Feasibility Geotechnical Studies	3-11
3.3.2 Scoping Design Phase Geotechnical Studies	3-12
3.3.3 Scoping Special Investigation Studies	3-13
3.3.4 Scope Revisions	3-14
3.4 Exploration and Testing Requirements	3-14
3.4.1 Subgrade Borings	3-15
3.4.1.1 Spacing Requirements	3-16
3.4.1.2 Depth Requirements	3-18
3.4.1.3 Sampling Requirements	3-19
3.4.2 Borings for Fill and Cut Areas	3-20
3.4.2.1 Spacing Requirements	3-23
3.4.2.2 Depth Requirements	3-23
3.4.2.3 Sampling Requirements	3-24
3.4.3 Structure Borings	3-24
3.4.3.1 General Boring Requirements	3-25
3.4.3.2 Borings for Bridges	3-25
3.4.3.3 Borings for Culverts	3-27
3.4.3.4 Borings for Retaining Walls & Other Earth Retention Systems	3-28
3.4.4 Special Investigation Explorations	3-30

3.4.4.1 Traffic Structure Borings	3-30
3.4.4.1.1 Sign Structure Borings	3-31
3.4.4.1.2 Traffic Signal Mast Arm Structure Borings.....	3-31
3.4.4.1.3 High Mast Lighting Structure Borings	3-31
3.4.4.2 Noise Abatement Wall Borings	3-32
3.4.4.3 Shelby Tube Borings	3-32
3.4.4.4 Pavement Coring.....	3-33
3.4.4.5 Pavement Rubblization Geotechnical Studies.....	3-34
3.4.4.6 Slope Failures.....	3-36
3.4.4.7 (Reserved).....	3-36
3.4.4.8 Bedrock Sounding and Coring	3-36
3.4.4.9 Peat Soundings	3-37
3.4.4.10 Groundwater Elevation Observation	3-38
3.4.4.11 Detention Ponds and Wetlands.....	3-38
3.4.4.12 Borrow Pits	3-39
3.4.5 Field and Laboratory Testing of Samples	3-39
Chapter 4 Subsurface Explorations & Field Testing	4-1
4.1 Introduction	4-1
4.2 Field Test Equipment Calibration, Verification, Standardization and Check Requirements	4-1
4.3 Departmental Subsurface Exploration and Testing Resources.....	4-3
4.4 Conducting Subsurface Explorations	4-3
4.4.1 Advanced Field Preparation	4-4
4.4.1.1 General Requirements.....	4-4
4.4.1.2 Subsurface Exploration Plan.....	4-5
4.4.1.3 Traffic Control	4-6
4.4.1.4 Locating Utilities	4-6
4.4.1.5 Permits	4-7
4.4.1.6 Property Access and Right of Entry Requirements	4-7
4.4.1.7 Bridge Decks	4-8
4.4.2 Field Operations Site Control.....	4-8
4.4.2.1 Boring and Excavation Pit Closure.....	4-9
4.4.2.2 Site Cleanup	4-10
4.4.3 (Reserved)	4-10

4.4.4 Sampling	4-10
4.4.4.1 – 4.4.4.5 (Reserved)	4-10
4.4.4.6 Shelby Tubes	4-11
4.4.4.7 Other Intact (Relatively Undisturbed) Sampling Systems	4-12
4.4.4.8 – 4.4.4.9 (Reserved)	4-12
4.4.5 In Situ and Field Tests	4-13
4.4.5.1 Borehole <i>In Situ</i> Tests	4-13
4.4.5.1.1 Standard Penetration Test	4-13
4.4.5.1.2 Vane Shear Test	4-14
4.4.5.2 Field Tests on Samples	4-15
4.4.5.2.1 Rimac Unconfined Compressive Test	4-15
4.4.5.2.2 Pocket Penetrometer	4-19
4.4.5.3 Penetrometer Tests	4-20
4.4.5.3.1 Cone Penetrometer Testing	4-20
4.4.5.3.2 Dynamic Cone Penetrometer	4-21
4.4.5.3.3 Static Cone Penetrometer	4-21
4.4.6 Characterization of Earth Materials	4-21
4.4.6.1 Soil Characterization	4-21
4.4.6.1.1 Field Identification of Soils	4-22
4.4.6.1.2 Consistency and Relative Density	4-24
4.4.6.2 Rock Characterization	4-25
4.4.6.2.1 Field Identification of Rock	4-26
4.4.6.2.2 Core Recovery Ratio and Rock Quality Designation	4-27
4.4.6.2.3 Rock Strength	4-28
4.4.7 Documentation of Exploration Records	4-29
4.4.7.1 Boring Logs	4-29
4.4.7.1.1 Field Logs	4-29
4.4.7.1.2 Soil Boring Logs	4-32
4.4.7.1.3 Rock Core Logs	4-36
4.4.7.1.4 Shelby Tube Boring Logs	4-39
4.4.7.2 Other Records	4-39
4.4.7.3 Electronic Data Submittal	4-41
4.5 (Reserved)	4-41
4.6 <i>In Situ</i> Instrumentation for Observations and Monitoring	4-42
4.6.1 Groundwater Observation Wells and Piezometers	4-42

4.6.2 – 4.6.3 (Reserved).....	4-43
4.7 Construction Inspection Tests.....	4-44
4.7.1 Field Density and Moisture Measurements.....	4-44
4.7.1.1 One-Point Method and Family of Curves	4-44
4.7.1.2 Nuclear Method	4-45
4.7.1.3 Sand-Cone Method.....	4-46
4.7.2 Strength Tests.....	4-46
4.7.2.1 Dynamic Cone Penetrometer.....	4-46
4.7.2.2 Static Cone Penetrometer.....	4-49
Chapter 5 Laboratory Testing and Soil Mix Designs.....	5-1
5.1 Introduction.....	5-1
5.2 Laboratory Accreditation and Inspection Requirements	5-1
5.3 Departmental Laboratory Facilities.....	5-2
5.3.1 Central Laboratory Facilities	5-2
5.3.2 District Laboratory Facilities.....	5-6
5.4 Mass, Weight and Volume Relationships.....	5-7
5.5 Laboratory Tests.....	5-10
5.5.1 Moisture Content	5-10
5.5.2 Specific Gravity	5-10
5.5.3 Particle Size Analysis	5-11
5.5.4 Atterberg Limits and Plasticity Index.....	5-12
5.5.4.1 Liquid Limit	5-12
5.5.4.2 Plastic Limit	5-12
5.5.4.3 Plasticity Index.....	5-13
5.5.4.4 Shrinkage Limit.....	5-13
5.5.5 Soil Classification	5-14
5.5.5.1 Illinois Division of Highways Textural Classification	5-14
5.5.5.2 AASHTO M 145 Classification	5-16
5.5.6 Organic Content	5-19
5.5.6.1 Wet Combustion Test.....	5-19
5.5.6.2 Loss on Ignition Test.....	5-20
5.5.7 Soil Corrosive Potential Tests.....	5-20
5.5.7.1 Resistivity	5-21
5.5.7.2 pH Value.....	5-21

5.5.7.3 Sulfate and Chloride Ion Content	5-21
5.5.8 pH of Soils for Non-Corrosive Applications	5-22
5.5.9 Triaxial Compression Tests	5-23
5.5.9.1 Unconsolidated-Undrained Test Method	5-23
5.5.9.2 Consolidated-Undrained Test Method.....	5-24
5.5.9.3 Consolidated-Drained Test Method	5-25
5.5.9.4 Triaxial Strength Parameters for Coulomb Equation	5-26
5.5.10 Unconfined Compression Test	5-28
5.5.11 Direct Shear	5-28
5.5.12 Compressive Strength of Rock	5-29
5.5.13 Consolidation Tests	5-29
5.5.13.1 One-Dimensional Consolidation and Settlement.....	5-31
5.5.13.2 Swelling and Rebound.....	5-33
5.5.13.3 Approximate Method for the Compression Index	5-33
5.5.14 Moisture-Density Relationship of Soils	5-34
5.5.14.1 Standard Proctor Test.....	5-37
5.5.14.2 Modified Proctor Test.....	5-38
5.5.14.3 Zero-Air-Voids Curve	5-38
5.5.14.4 One-Point Method and Family of Curves	5-38
5.5.15 Relative Density Testing	5-39
5.5.16 Illinois Bearing Ratio (IBR) Test.....	5-39
5.5.17 Immediate Bearing Value	5-41
5.5.18 (Reserved)	5-42
5.6 Soil Modification and Stabilization Mix Design Procedures	5-42
5.6.1 Soil Modification Mixtures (Lime, Fly Ash, Slag Cement, Portland Cement)	5-42
5.6.2 Soil Stabilization Mixtures.....	5-44
5.6.2.1 Lime Stabilized Soil Mixture	5-44
5.6.2.2 Soil-Cement.....	5-44
5.6.2.3 Cement Aggregate Mixture	5-44
5.6.2.4 Pozzolan Stabilized Mixture	5-45
5.7 Documentation of Laboratory Test Data and Results	5-45
5.7.1 Laboratory Test Results	5-45
5.7.2 Electronic Data Submittal	5-46

Chapter 6 Geotechnical Design	6-1
6.1 Introduction	6-1
6.1.1 Analyses and Evaluations	6-1
6.1.2 Recommendations	6-1
6.2 Roadways Overview	6-3
6.3 Subgrades	6-4
6.3.1 Pavement Design Soil Parameters (SSR and IBR).....	6-4
6.3.2 Subgrade Material Suitability and Stability.....	6-6
6.3.2.1 Stability of Subgrades.....	6-7
6.3.2.2 Material Suitability.....	6-7
6.3.2.2.1 Highly Organic Soils.....	6-8
6.3.2.2.2 Suitability of Topsoil	6-8
6.3.2.2.3 Frost Susceptibility and Detrimental Frost Action of Subgrades	6-8
6.3.2.2.3.1 Frost Susceptibility Evaluation.....	6-9
6.3.2.2.3.2 Detrimental Frost Action Treatments	6-12
6.3.2.2.4 High Shrink/Swell Potential Soils	6-13
6.3.2.2.5 Other Unsuitable/Unstable Soils	6-13
6.3.3 Treatment of Subgrade.....	6-14
6.3.3.1 Treatment Evaluation.....	6-14
6.3.3.2 Treatment Recommendations.....	6-15
6.3.3.3 Treatment Methods.....	6-17
6.3.3.3.1 Moisture Conditioning and Drainage	6-18
6.3.3.3.2 Use of Additives	6-19
6.3.3.3.2.1 Drying Agent	6-21
6.3.3.3.2.2 Soil Modification	6-21
6.3.3.3.2.3 Soil Stabilization	6-21
6.3.3.3.2.4 Mix Design Evaluation and Recommendations.....	6-22
6.3.3.3.3 Removal and Replacement (or Undercut and Backfill)	6-24
6.3.3.3.4 Soil Reinforcement.....	6-25
6.3.3.3.5 Structure Option.....	6-27
6.3.4 Pavement Drainage.....	6-27
6.3.4.1 Drainage Classes	6-27
6.3.4.2 Drainage Systems and Filters for the Pavement Structure.....	6-30
6.3.4.3 Subsurface Drainage Design Considerations.....	6-31

6.4 Embankments	6-33
6.4.1 Embankment Material Properties	6-33
6.4.2 Embankment Settlement	6-34
6.4.3 Embankment Stability	6-36
6.4.4 Remedial Treatments	6-37
6.4.4.1 Removal and Replacement.....	6-38
6.4.4.2 Peat Bog Removal and Replacement Treatments	6-39
6.4.4.3 Drainage and Filter Systems to Aid in Consolidation.....	6-42
6.4.4.3.1 Drainage Blankets.....	6-42
6.4.4.3.2 Vertical Sand and Wick Drains.....	6-42
6.4.4.4 Preloading/Surcharge	6-43
6.4.4.5 Embankment Geometry	6-44
6.4.4.6 Instrumentation and Control of Embankment Construction	6-44
6.4.4.7 Lightweight Fills	6-45
6.4.4.8 Ground Improvement.....	6-46
6.4.4.9 Embankment Reinforcement	6-47
6.4.4.9.1 Base Reinforcement	6-48
6.4.4.9.2 Reinforced Soil Slopes.....	6-49
6.4.4.9.2.1 RSS Analysis and Design.....	6-49
6.4.4.9.2.2 RSS Design Recommendations	6-51
6.4.4.10 Structure Option.....	6-52
6.5 Cut Slopes	6-53
6.5.1 Cut Slopes Stability	6-53
6.5.2 Remedial Treatments	6-53
6.5.2.1 (Reserved).....	6-54
6.5.2.2 Drainage and Filter Systems in Backslope Applications.....	6-54
6.5.2.3 (Reserved).....	6-55
6.5.3 (Reserved)	6-55
6.6 Erosion Control.....	6-55
6.7 Storm Sewers	6-57
6.8 Structures	6-58
6.8.1 Design Criteria Overview.....	6-58
6.8.2 Structure Type and Scope.....	6-58
6.8.2.1 Bridges	6-58
6.8.2.1.1 Analyses for Bridges	6-59

6.8.2.1.2 Design Recommendations for Bridges	6-60
6.8.2.2 Culverts	6-60
6.8.2.2.1 Analyses for Culverts	6-61
6.8.2.2.2 Design Recommendations for Box Culverts	6-61
6.8.2.2.3 – 6.8.2.2.7 (Reserved)	6-61
6.8.2.3 Three Sided Structures	6-62
6.8.2.4 Retaining Walls	6-63
6.8.2.4.1 – 6.8.2.4.5 (Reserved)	6-63
6.8.2.5 Miscellaneous Structures	6-63
6.8.3 Drainage and Drainage Systems for Structures	6-63
6.9 Settlement Analyses	6-64
6.9.1 Consolidation Settlement Analysis	6-64
6.9.1.1 Preliminary Assessment	6-65
6.9.1.2 Consolidation Tests and Settlement Analysis	6-67
6.9.2 Immediate Settlement Analyses	6-67
6.9.3 Other Settlement Types	6-68
6.9.4 Settlement Evaluation and Remedial Treatment for Structures	6-68
6.10 Slope Stability Analyses	6-70
6.10.1 General Failure Mechanisms	6-70
6.10.2 Preliminary Assessment	6-72
6.10.3 Analysis Based on SPT Data	6-72
6.10.4 Analysis Based on Shelby Tube Data	6-73
6.10.5 Discussion of Slope Stability Analysis	6-73
6.10.6 (Reserved)	6-75
6.10.6.1 (Reserved)	6-75
6.11 Scour Evaluations and Countermeasure Treatments	6-76
6.12 Seismic Analysis	6-77
6.12.1 Seismic Evaluation and Design Recommendations	6-77
6.12.1.1 Applications	6-77
6.12.1.2 Seismic Loading	6-77
6.12.1.3 Remedial Treatments	6-78
6.12.2 Seismic Design Parameters for Structures	6-78
6.12.2.1 LRFD Seismic Parameters	6-78
6.12.2.1.1 Soil Site Class Definition	6-78
6.12.2.1.2 Design Spectral Acceleration Coefficients	6-79

6.12.2.1.3 Seismic Performance Zone	6-80
6.12.2.2 LFD Seismic Parameters	6-81
6.12.2.3 (Reserved).....	6-83
6.12.3 Seismic Liquefaction.....	6-83
6.12.4 (Reserved)	6-84
6.12.4.1 Seismic Slope Stability Deformations.....	6-84
6.12.5 (Reserved)	6-84
6.13 Foundation Type Selection and Analysis.....	6-85
6.13.1 Shallow Foundations (Spread Footings).....	6-85
6.13.1.1 – 6.13.1.6 (Reserved).....	6-85
6.13.2 Pile Foundations.....	6-85
6.13.2.1 Pile Types.....	6-86
6.13.2.1.1 Steel H-Piles	6-87
6.13.2.1.2 Metal Shell Piles	6-87
6.13.2.1.3 (Reserved).....	6-89
6.13.2.1.4 Precast Concrete Piles.....	6-89
6.13.2.1.5 Timber Piles.....	6-90
6.13.2.2 General Pile Selection and Spacing Considerations	6-91
6.13.2.2.1 Reuse of Existing Pile Foundations.....	6-91
6.13.2.3 Axial Resistance	6-92
6.13.2.3.1 Nominal Required Bearing, Factored Resistances Available, and Estimated Length.....	6-93
6.13.2.3.1.1 Nominal Required Bearing	6-94
6.13.2.3.1.2 Maximum Nominal Required Bearing	6-101
6.13.2.3.1.3 Factored Resistance Available	6-103
6.13.2.3.1.4 Estimated Length	6-107
6.13.2.3.2 Geotechnical Losses.....	6-110
6.13.2.3.2.1 Scour.....	6-110
6.13.2.3.2.2 Downdrag.....	6-111
6.13.2.3.2.3 Liquefaction.....	6-114
6.13.2.3.3 Uplift Resistance	6-115
6.13.2.3.4 Pile Driving Considerations	6-116
6.13.2.3.4.1 Test Piles	6-117
6.13.2.3.4.2 Site Conditions	6-119
6.13.2.3.4.3 Pile Shoes and Conical Tips.....	6-120

6.13.2.3.4.4 Precoring at Pile Locations.....	6-121
6.13.2.3.4.5 Pile Setup and Relaxation	6-123
6.13.2.3.5 Piles Set in Rock.....	6-124
6.13.2.4 Lateral Resistance	6-125
6.13.2.4.1 Battered Piles.....	6-126
6.13.2.4.2 Soil-Structure Interaction Analysis.....	6-128
6.13.2.4.2.1 Pile Fixity Depths.....	6-130
6.13.2.4.2.2 Piles Set in Rock	6-134
6.13.2.5 Integral Abutments.....	6-135
6.13.2.6 (Reserved).....	6-136
6.13.3 Drilled Shaft Foundations	6-136
6.13.3.1 – 6.13.3.4 (Reserved).....	6-137
6.13.4 (Reserved)	6-137
6.13.5 Miscellaneous Structure Foundations.....	6-137
6.13.5.1 Traffic Signal Mast Arms, High Mast Lighting Towers, and Sign Structures	6-137
6.13.5.2 Noise Abatement Walls.....	6-139
6.14 Construction Details	6-139
6.15 Special Problems	6-140
6.16 Contract Documents	6-140
6.16.1 Standard Specifications and Special Provisions	6-140
6.16.2 Project Specific Special Provisions.....	6-141
6.17 Drainage System Filter Requirements	6-142
6.18 Geosynthetics – An Overview	6-144
6.18.1 Geosynthetic Types and Applications.....	6-144
6.18.1.1 Geocells	6-145
6.18.1.2 Geocomposites.....	6-145
6.18.1.3 Geofoam.....	6-145
6.18.1.4 Geogrids.....	6-146
6.18.1.5 Geomembranes and Geonets.....	6-146
6.18.1.6 Geotextiles.....	6-146
6.18.2 Usage by IDOT.....	6-147
6.19 Design Guides & Spreadsheets	6-148

Chapter 7 Geotechnical Reports	7-1
7.1 Introduction	7-1
7.2 Corridor and Preliminary Feasibility Geotechnical Reports	7-2
7.2.1 Corridor Geotechnical Reports	7-2
7.2.2 Preliminary Feasibility Geotechnical Reports.....	7-3
7.3 Roadway Geotechnical Report	7-4
7.3.1 RGR Study Determination and Reporting Criteria.....	7-4
7.3.2 Submittal and Review Process	7-5
7.3.3 RGR Format and Content.....	7-5
7.3.3.1 Cover Sheet and Table of Contents.....	7-6
7.3.3.2 Project Description, Location and Scope	7-6
7.3.3.3 Geology and Pedology	7-6
7.3.3.4 Field Exploration.....	7-7
7.3.3.4.1 Climatic Conditions Summary	7-8
7.3.3.5 General Subgrade Conditions.....	7-8
7.3.3.6 Slope Stability Analysis and Results	7-13
7.3.3.7 Settlement Analysis and Results.....	7-13
7.3.3.8 Minor Structure Foundation Recommendations	7-13
7.3.3.9 Special Conditions	7-14
7.3.3.10 Construction Monitoring.....	7-14
7.3.3.11 Appendices (Supporting Documentation).....	7-14
7.3.3.11.1 Location Map	7-15
7.3.3.11.2 Boring Plan and Soil Profile.....	7-17
7.3.3.11.3 Boring Logs.....	7-25
7.4 Structure Geotechnical Report	7-26
7.4.1 SGR Study Determination and Reporting Criteria.....	7-26
7.4.1.1 SGR Project Limits	7-29
7.4.2 Submittal and Review Process	7-29
7.4.3 Borings Only (No SGR Required).....	7-32
7.4.4 Abbreviated SGR	7-32
7.4.5 SGR (Typical).....	7-35
7.4.5.1 Cover Sheet and Table of Contents.....	7-35
7.4.5.2 Project Description and Scope.....	7-35
7.4.5.3 Field Exploration.....	7-37
7.4.5.4 Geotechnical Evaluations and Recommendations	7-38

7.4.5.5 Foundation Recommendations	7-39
7.4.5.6 Construction Considerations	7-41
7.4.5.7 Appendices (Supporting Documentation).....	7-42
7.4.6 Geotechnical Design Memorandum.....	7-45
7.5 Special Investigations.....	7-48
7.5.1 Pavement Rubblization Geotechnical Report	7-48
Chapter 8 Geotechnical Construction Inspection	8-1
8.1 Introduction.....	8-1
8.2 Construction Inspection Training.....	8-2
8.3 Embankment Construction.....	8-3
8.4 Borrow and Excavation Materials	8-5
8.5 Compaction and Density Testing.....	8-7
8.6 Placement of Backfill	8-8
8.6.1 Importance of Backfill Characteristics.....	8-8
8.6.1.1 Strength and Compressibility.....	8-8
8.6.1.2 Drainage and Selection of Materials	8-9
8.6.2 Construction Problems and Effective Inspection.....	8-10
8.7 Subgrade Construction and Subgrade Stability	8-11
8.8 Shallow Foundation / Spread Footing Inspection.....	8-15
8.9 Foundation Preparation for Box Culverts	8-16
8.10 Pile Foundation Construction Inspection.....	8-18
8.10.1 Interpretation of Boring Logs.....	8-18
8.10.2 <i>Drive System Acceptability</i>	8-20
8.10.3 Precoring at Pile Locations	8-21
8.10.4 Pile Damage	8-22
8.10.5 Test Piles.....	8-25
8.10.6 Nominal Required Bearing and Pile Length	8-26
8.10.6.1 WSDOT Pile Driving Formula	8-27
8.10.6.2 WEAP Program Analysis	8-28
8.10.6.3 Dynamic Testing.....	8-30
8.10.6.4 Lateral Capacity and Fixity.....	8-30
8.10.6.5 Documentation for Production Pile Driving.....	8-30
8.10.7 Dynamic and Static Pile Capacity Testing	8-31
8.10.7.1 Dynamic Testing.....	8-32

8.10.7.2 Static Load Tests	8-33
8.10.8 Piles Set in Rock	8-34
8.11 Drilled Shaft Foundation Inspection	8-35
8.11.1 – 8.11.4 (Reserved).....	8-36
8.11.5 Construction Inspection Documentation	8-36
8.12 Use of Geosynthetics for Roadway Applications	8-36
8.13 Erosion Control.....	8-38
Appendix A Geology and Pedology.....	A-1
A.1 Introduction	A-1
A.2 Pleistocene Geology	A-2
A.3 Pre-Pleistocene Geology	A-6
A.4 Physiographic Divisions	A-9
A.5 General Character of Glacial Deposits.....	A-11
A.5.1 Ground Moraine or Till Plains.....	A-11
A.5.2 Morainic Ridges or Moraines.....	A-15
A.5.3 Outwash Plains	A-16
A.5.4 Alluviated Valleys.....	A-17
A.5.5 Glacial Lakebed Sediments.....	A-17
A.5.6 Ice-Contact Stratified Drift.....	A-20
A.6 Wind Deposits	A-20
A.6.1 Sand Dunes	A-21
A.6.2 Loess	A-21
A.7 Organic Deposits.....	A-24
A.7.1 Origin and Classification	A-24
A.7.2 Distribution and Occurrence.....	A-26
A.8 Buried Soils and Other Interglacial Deposits	A-27
A.9 Holocene (“Recent”) Deposits.....	A-27
A.9.1 Valley Deposits	A-27
A.9.2 Depressional Deposits	A-29
A.9.3 Colluvium.....	A-30
A.9.4 Artificial Fill Materials	A-30
A.10 Thickness of Pleistocene Deposits – Bedrock Topography.....	A-30
A.11 Bedrock Deposits	A-33
A.11.1 Shale	A-33

A.11.2 Limestones and Dolomites	A-34
A.11.3 Sandstone.....	A-36
A.11.4 Coal	A-36
A.11.5 Interbedded Sedimentary Rocks	A-36
A.11.6 Mined-Out Areas	A-37
A.12 Structural Geology and Seismic Activity	A-39
A.13 Pedology	A-40
A.14 The Soil Profile	A-41
A.15 Pedologic Classification and Mapping Units.....	A-44
A.15.1 Soil Series.....	A-44
A.15.2 Soil Type.....	A-44
A.15.3 Soil Phase.....	A-45
A.15.4 Soil Association.....	A-45
Appendix B Laboratory Test and Mix Design Procedures	B-1
B.1 Laboratory Test and Mix Design Procedures	B-1
B.2 Method of Determining the IBR and the IBV of Soils, Treated Soils, and	
Aggregates	B-2
B.2.1 IBR Test.....	B-2
B.2.1.1 Scope.....	B-2
B.2.1.2 Equipment.....	B-2
B.2.1.3 Sample	B-3
B.2.1.4 Procedure	B-3
B.2.1.5 Soaking	B-4
B.2.1.6 Penetration Test.....	B-4
B.2.1.7 Calculations.....	B-4
B.2.1.8 Report	B-4
B.2.2 IBV Testing	B-5
B.2.2.1 Scope.....	B-5
B.2.2.2 Equipment.....	B-5
B.2.2.3 Sample	B-5
B.2.2.4 Procedure	B-6
B.2.2.5 Calculations.....	B-7
B.2.2.6 Report	B-7

B.3 Soil Modification with Various Materials: Laboratory Evaluation/Design	
Procedure	B-8
B.3.1 Scope	B-8
B.3.2 Equipment.....	B-8
B.3.3 Samples.....	B-8
B.3.4 Procedures	B-8
B.3.5 IBR Test (Optional)	B-10
B.3.6 Report.....	B-11
B.4 Lime Stabilized Soil Mixtures: Laboratory Evaluation/Design Procedures.....	B-12
B.4.1 Scope	B-12
B.4.2 Equipment.....	B-12
B.4.3 Samples.....	B-15
B.4.4 Procedure	B-15
B.4.5 Report.....	B-17
B.5 Soil-Cement Mixture: Laboratory Evaluation/Design Procedure	B-18
B.5.1 Scope	B-18
B.5.2 Equipment.....	B-18
B.5.3 Samples.....	B-18
B.5.4 Procedure	B-18
B.5.5 Report.....	B-21
B.6 Cement Aggregate Mixture: Laboratory Evaluation/Design Procedures.....	B-22
B.6.1 Scope	B-22
B.6.2 Apparatus	B-22
B.6.3 Samples.....	B-22
B.6.4 Procedure	B-22
B.6.5 Reports	B-23
B.7 Pozzolanic Stabilized Mixture: Laboratory Evaluation/Design Procedure	B-24
B.7.1 Scope	B-24
B.7.2 Equipment.....	B-24
B.7.3 Samples.....	B-24
B.7.4 General Approach.....	B-24
B.7.6 Preparation of Aggregate/Pozzolan.....	B-25
B.7.7 Moisture-Density Relationship.....	B-25
B.7.8 Mix Design Procedure.....	B-26
B.7.9 Determining Compressive Strength.....	B-27

B.7.10 Plotting of Cured Compressive Strength (CS) vs. Degree Days (DD)
 Characteristic Curve B-29

B.7.11 Report..... B-30

Appendix C Field Test Procedures and References C-1

C.1 Field Test Procedure for Unconfined Compressive Strength of Cohesive Soil

(Rimac)..... C-1

C.1.1 Scope C-1

C.1.2 Referenced Documents C-2

C.1.3 Terminology..... C-3

C.1.4 Significance and Use C-4

C.1.5 Equipment C-4

C.1.6 Test Specimen Preparation..... C-5

C.1.7 Procedure C-7

C.1.8 Calculations C-8

C.1.9 Report..... C-9

C.2 Comparison of Laboratory and Rimac Q_u Data C-11

C.2.1 IDOT Historic Unconfined Compressive Strength and Rimac Data C-13

C.2.2 Unconfined Compressive Strength and Rimac Regression Details C-17

C.3 Geotechnical Pile Resistance Tables C-20

Appendix D Settlement Analysis Procedure..... D-1

D.1 Scope D-1

D.2 Obtaining Data D-1

D.3 Units D-1

D.4 General Guidelines D-1

D.5 Log-Fitting Procedure D-2

D.6 Square Root-Fitting Procedure..... D-4

D.7 Determining the Coefficient of Consolidation (c_v)..... D-5

D.8 Determining the Effective Overburden and Applied Pressures D-7

D.9 Primary Settlement Calculations D-10

D.9.1 Void Ratio Verses Log Pressure (e-log P) Curve Development D-10

D.9.1.1 Determine Volume of Solids..... D-10

D.9.1.2 Calculate Void Ratio for Each Load Increment..... D-10

D.9.1.3 Plot Laboratory Compression Data Curve D-10

D.9.1.4 Develop Field “Virgin” Curve D-11

D.9.2 Magnitude of Settlement Calculation.....	D-14
D.9.2.1 Individual Layer Calculation	D-14
D.9.2.1.1 Method A.....	D-14
D.9.2.1.2 Method B.....	D-14
D.9.2.2 Multi-Layer Calculation.....	D-16
D.9.3 Settlement Time Estimation	D-16
D.9.3.1 Individual Layer Calculation	D-16
D.9.3.2 Multi-Layer Calculation.....	D-17
D.9.3.2.1 Method A.....	D-17
D.9.3.2.2 Method B.....	D-17
D.10 Secondary Consolidation	D-18
D.11 Report.....	D-19
D.12 References	D-20
Appendix E Glossary of Soil Terms	E-1
Appendix F Bibliography	F-1
F.1 Introduction.....	F-1
F.2 General References	F-1
F.3 FHWA Publications.....	F-11
F.4 District Specific References.....	F-15
F.4.1 District 1	F-15
F.4.2 District 2.....	F-17
F.4.3 District 3.....	F-20
F.4.4 District 4.....	F-22
F.4.5 District 5.....	F-24
F.4.6 District 6.....	F-25
F.4.7 District 7.....	F-27
F.4.8 District 8.....	F-29
F.4.9 District 9.....	F-31

LIST OF FIGURES AND TABLES

Figure 1.2-1 IDOT Geotechnical Engineering Organizational Chart 1-3

Figure 3.4.1-1 Subsurface Exploration – Subgrade and Embankment/Cut Boring Spacing
and Depth Flow Chart 3-15

Figure 3.4.1.1-1 Boring Spacing Requirements for Subgrade Borings in areas with
cuts/fills less than 15 ft. in height..... 3-16

Figure 3.4.1.1-2 Boring Spacing for Subgrade Borings in Terrain with Minimal Topographic
Relief and Uniform Soil Conditions 3-17

Figure 3.4.1.2-1 Minimum Boring Depth Requirements for Subgrade Borings in areas with
cuts/fills less than 15 ft. in height..... 3-19

Figure 3.4.2-1(a) Boring Spacing for Embankments Greater than or equal to 15 ft. 3-21

Figure 3.4.2-1(b) Minimum Boring Depths for Embankments Greater than or equal to 15
ft..... 3-21

Figure 3.4.2-2(a) Boring Spacing for Cut Depths Greater than or equal to 15 ft. 3-22

Figure 3.4.2-2(b) Minimum Boring Depths for Cut Depths Greater than or equal to 15 ft..... 3-22

Table 4.4.1.4-1 Utility Location Contacts 4-6

Figure 4.4.5.2.1-1(a) Rimac Spring Tester without gearbox modification..... 4-17

Figure 4.4.5.2.1-1(b) Rimac Spring Tester and Soil Sample..... 4-18

Figure 4.4.6.1.1-1 Simplified Flow Chart for Field Identification of Soils 4-23

Table 4.4.6.1.2-1 Relative Density and Friction Angle of Cohesionless Soils 4-25

Table 4.4.6.1.2-2 Strength and Consistency of Cohesive Soils 4-25

Table 4.4.6.2.1-1 Basic Sedimentary Rock Identification..... 4-27

Table 4.4.6.2.2-1 Relation of RQD to In situ Rock Quality..... 4-28

Figure 4.4.7.1.2-1 Example Soil Boring Log 4-35

Figure 4.4.7.1.3-1 Example Rock Core Log 4-38

Figure 4.4.7.1.4-1 Example Soil Boring Log Indicating Shelby Tube Sample Locations 4-40

Figure 4.7.2.1-1 The DCP Apparatus 4-48

Figure 4.7.2.2-1 The SCP Apparatus 4-50

Figure 5.4-1 Phase Diagram for a Soil Mass..... 5-7

Table 5.4-1 Soil Mass and Volumetric Relationships..... 5-9

Figure 5.5.4-1 Schematic showing Atterberg Limits and Corresponding Physical States of Soil in the Remolded Condition verses Moisture Content	5-13
Figure 5.5.5.1-1 IDH Textural Classification Chart	5-15
Table 5.5.5.1-1 IDH Particle Size Limits of Soil Constituents defined in AASHTO M 146	5-16
Table 5.5.5.2-1 AASHTO Classification of Soils and Soil-Aggregate Mixtures, AASHTO M 14.....	5-18
Figure 5.5.9-1 Schematic Diagram of the Triaxial Test Apparatus.....	5-24
Figure 5.5.9-2 Diagram of the Assumed Stress Conditions for Triaxial Compression	5-25
Figure 5.5.9-3 Typical Mohr Failure Diagrams for Triaxial Tests on Various Types of Soils	5-27
Figure 5.5.13.1-1 Void Ratio vs. Log Pressure Curves Typical of Various Clay Samples	5-32
Figure 5.5.14-1 Moisture-Density Relationship Curve with Corresponding IBV Curve	5-36
Table 5.5.16-1 Typical IBR Values for Illinois Soils	5-41
Figure 5.7.1-1(a) Example Completed Shelby Tube Test Results Form.....	5-47
Figure 5.7.1-1(b) Example Completed Shelby Tube Test Results Form.....	5-48
Table 6.3.1-1 Estimated IBR Values	6-6
Table 6.3.2.2.3-1 Frost Susceptibility Classification of Soils	6-11
Table 6.3.3.3.2.3-1 Thickness Requirements for Lime Stabilized Soil Layers *	6-22
Table 6.3.4.1-1 Drainage Classification.....	6-29
Figure 6.4.4.2-1 Width of removal and replacement in peat bogs.....	6-40
Table 6.12.2.1.1-1 LRFD Seismic Soil Site Class Definition Categories.....	6-79
Table 6.12.2.1.3-1 LRFD Seismic Performance Zones for 1000-yr. Design Return Period Earthquake.....	6-81
Figure 6.12.2.2-1 Horizontal Bedrock Acceleration Map for the State of Illinois (500-year Return Period).....	6-82
Table 6.13.2.1.2-1 Metal Shell Pile Sizes	6-88
Table 6.13.2.3.1.2-1 Empirical Relationships for the Maximum Nominal Required Bearing for Driven Piles.....	6-101
Table 6.13.2.3.1.2-2 Maximum Nominal Required Bearing Values for Driven Piles.....	6-102
Table 6.13.2.3.1.4-1 Example Pile Design Table for SGRs.	6-108
Figure 6.13.2.4.2.1-1 Relationship between the P-y Method and the Simplified Beam Equations for the Free Pile Head Case	6-131
Figure 6.13.2.4.2.1-2 Relationship between the P-y Method and the Simplified Beam Equations for the Fixed Pile Head Case	6-131

Figure 6.13.2.4.2.1-3 Example Summary of P-y Method Analysis Pile Length Verses Pile Head Deflection to Determine the Critical Pile Length	6-132
Figure 6.13.2.4.2.1-4(a) Example Relationship between Applied Shear and Depth to Fixity for Deflection.....	6-133
Figure 6.13.2.4.2.1-4(b) Example Relationship between Applied Shear and Depth to Fixity for Moment.....	6-134
Table 6.19-1 Geotechnical Design Guides & Spreadsheets Summary.....	6-148
Table 6.19-1 Geotechnical Design Guides & Spreadsheets Summary (Continued)	6-149
Table 7.3.3.4.1-1 Example Comparison of Actual and Historical Precipitation.....	7-8
Table 7.3.3.5-1 Example Schedule of Subgrade Treatment Recommendations.....	7-9
Figure 7.3.3.5-1 Example Soil Test Data (Form BMPR 508A).....	7-10
Figure 7.3.3.5-2 Subgrade Support Rating (SSR Chart).....	7-11
Figure 7.3.3.5-3 Example Summary Report on Pavement, Base, and Subbase Design (Form BMPR 507A).....	7-12
Figure 7.3.3.11.1-1 Example of Typical Location Map.....	7-16
Figure 7.3.3.11.2-1(a) Example Boring Plan and Soil Profile.....	7-19
Figure 7.3.3.11.2-1(b) Example Boring Plan and Soil Profile.....	7-21
Figure 7.3.3.11.2-1(c) Example Boring Plan and Soil Profile	7-23
Table 7.4.1-1 SGR Category Criteria	7-28
Figure 7.4.2-1 SGR Submittal and Review Process	7-31
Table 7.4.5-1 Example SGR Table of Contents.....	7-36
Figure 7.4.5.7-1 Example Subsurface Data Profile Plot.....	7-43
Table 8.4-1 Requirements of Borrow and Furnished Excavation Soils for the Top 24 in. Subgrade.	8-7
Figure 8.7-1 DCP's PR Values vs. IBV in English Units	8-12
Figure 8.7-2 Thickness design as a function of IBV for granular backfill and lime modified soil remedial action (from SSM)	13
Table 8.9-1 Guideline for Working Platforms at Culverts.....	8-17
Table 8.10.1-1 Driving Conditions for Displacement Piles.....	8-19
Table 8.10.6-1 Estimated Percent Gain Likely for Nominal Driven Bearing of Piles after EOD	8-28
Table A.2-1 Stratigraphic Classifications of the Pleistocene Deposits in Illinois.....	A-3
Figure A.2-1 Stratigraphic Relationships of the Mason and Wedron Group Units.....	A-4
Figure A.2-2 Quaternary Deposits of Illinois	A-5
Figure A.3-1 Generalized Areal Geology of the Bedrock Surface of Illinois	A-7

Table A.3-1 Principal Bedrock Strata of Illinois..... A-8

Figure A.4-1 Physiographic Divisions of Illinois A-10

Figure A.5.1-1 USDA/NRCS Textural Classification Diagram..... A-13

Figure A.5.1-2 USDA/NRCS Textural Classification of Loess and Tills A-14

Figure A.5.5-1 Glacial Lakes of Illinois A-19

Figure A.6.1-1 Major Areas of Windblown Sand in Illinois A-22

Figure A.6.2-1 Loess Thickness in Illinois A-23

Figure A.8-1 Diagrammatic Cross Section Showing Relations of Pleistocene Formations
and Members of Illinois Episode in Western Illinois A-28

Figure A.10-1 Thickness of Glacial Drift of Illinois A-31

Figure A.10-2 Topography of the Bedrock Surface of Illinois..... A-32

Table A.14-1 A Hypothetical Soil Profile Showing Its Major Characteristics A-43

Figure A.15.4-1 Generalized Soil Map of Illinois..... A-46

Figure B.4.2-1 Specimen Mold Assembly..... B-13

Figure B.4.2-2 Compaction Hammer..... B-14

Figure B.4.2-3 Sample Extruder..... B-15

Table B.5.4-1 Cement Requirements of AASHTO Soil Group Classification B-19

Table B.7.8-1 Suggested Percentages (Dry Weight Basis) of Ingredients to be Used in
Pozzolanic Stabilized Mixture Design..... B-26

Table B.7.8-2 Estimation of – No. 4 (4.75 mm) Material Needed..... B-26

Table B.7.9-1 Factors for Estimating Standard Deviation B-29

Table C.1-1 Rimac Conversion Table for 1-3/8 inch Diameter Sample..... C-10

Table C.2-1 Results of Regression Analysis for Q_u vs. Rimac for 325 Data Pairs from
Bridge Sites in Illinois C-12

Figure C.2-1 Proposed Rimac- Q_u relation with approximate 90% confidence intervals
plotted with linear axes (left) and log-log axes (right)..... C-13

Table C.2.1-1 Statistical properties of IDOT’s original Q_u -Rimac dataset and the USGS
digitized dataset C-14

Figure C.2.1-1 Rimac- Q_u Relationship with Lab Q_u : “All data” C-15

Figure C.2.1-2 Rimac- Q_u Relationship with Lab Q_u : “CLAYS” C-16

Figure C.2.1-3 Rimac- Q_u Relationship with Lab Q_u : “SILTS” C-16

Figure C.2.1-4 Rimac- Q_u Relationship with Lab Q_u : “SANDS”..... C-17

Table C.3-1 12 inch Metal Shell Geotechnical Pile Resistance C-21

Table C.3-2 14 inch Metal Shell Geotechnical Pile Resistance C-22

Table C.3-3 16 inch Metal Shell Geotechnical Pile Resistance C-23

Table C.3-4 HP 8 Geotechnical Pile Resistance	C-24
Table C.3-5 HP 10 Geotechnical Pile Resistance	C-25
Table C.3-6 HP 12 Geotechnical Pile Resistance	C-26
Table C.3-7 HP 14 Geotechnical Pile Resistance	C-27
Table C.3-8 HP 16 Geotechnical Pile Resistance	C-28
Table C.3-9 HP 18 Geotechnical Pile Resistance	C-29
Figure D.5-1 Log-Fitting Determination of 0% and 100% Consolidation	D-3
Figure D.6-1 Square Root-Fitting Determination of 0% and 100% Consolidation	D-5
Figure D.8-1 Example of Effective Overburden Pressure (P'_o) Calculation	D-7
Table D.8-1 Examples of the Use of the Influence Chart (Osterberg, 1957)	D-9
Figure D.9.1-1 Construction of the “Virgin” e-log P Curve	D-12

This page left intentionally blank.

ABBREVIATIONS AND DESCRIPTIONS

Abbreviations

The following is an alphabetical listing of abbreviations, acronyms, and shortened titles used in this Manual; followed by their full title:

ACGI — Aggregate Column Ground Improvement

AAP — AASHTO Accreditation Program

AASHTO — American Association of State Highway and Transportation Officials

ABD — All Bridge Designers

AGMU — All Geotechnical Manual Users

BBS — (IDOT) Bureau of Bridges and Structures

BCR — Bridge Condition Report

BDE — (IDOT) Bureau of Design and Environment

BOR — Beginning-of-Redrive

CAM — Cement Aggregate Mixture

CAPWAP[®] — CAse Pile Wave Analysis Program

CBM — (IDOT) Central Bureau of Materials

CCB — Coal Combustion By-Product

CCRL — Cement Concrete Reference Laboratory

CIP — Cast-In-Place

CPT — Cone Penetrometer Testing

CSU — Concrete and Soils Unit

DCP — Dynamic Cone Penetrometer

DGE — (IDOT) District Geotechnical Engineer

DOT — Department of Transportation

EFA — Erosion Function Apparatus

EOD — End of Driving

Eq. — Equation

ETR — Energy Transfer Ratio

EWSE — Estimated Water Surface Elevation

FGU — Foundations and Geotechnical Unit

FHWA — Federal Highway Administration

FOS — Factor of Safety

GBSP — Guide Bridge Special Provision

GIS — Geographic Information System

GPR — Ground Penetration Radar

HEC — Hydraulic Engineering Circular

HMA — Hot Mix Asphalt

IBR — Illinois Bearing Ratio

IBV — Immediate Bearing Value

lbf & lbm — Pound Force & Pound Mass, respectively

IDH — Illinois Division of Highways

IDOT — Illinois Department of Transportation

IFAI — Industrial Fabrics Association International

ILCS — Illinois Compiled Statutes

ISGS — Illinois States Geological Survey

ITP — Illinois Test Procedure

ksf — Kips per Square Foot

ksi — Kips per Square Inch

LBU — Local Bridge Unit

LiDAR — Light Detection and Ranging

LL — Liquid Limit

LRFD — Load and Resistance Factor Design

MPD — Mechanistic Pavement Design

MSE — Mechanically Stabilized Earth

MSPT — Modified Standard Penetration Test

N — Blow Count (The number of blows required to drive the sampler 300 mm (12 inches) in a SPT test.)

NHI — National Highway Institute

NPDES — National Pollutant Discharge Elimination System

OMC — Optimum Moisture Content (AASHTO T 99, unless otherwise specified)

PBDHR — Preliminary Bridge Design and Hydraulic Report

PCBC — Precast Concrete Box Culvert

PCC — Portland Cement Concrete

pcf — Pounds per Cubic Foot

PDA — Pile Driving Analyzer[®]

PDF — Portable Document Format

PESA — Preliminary Environmental Site Assessment

PGA — Peak Ground Acceleration

PGL — Proposed Grade Line

PI — Plasticity Index

PL — Plastic Limit

PP — pocket penetrometer

PPG — Project Procedures Guide

PR — Penetration Rate (The depth of penetration mm (inches) per blow in a DCP test.)

PS&E — Plans, Specifications, & Estimates

psf — Pounds per Square Foot

PVD — Prefabricated Vertical Drain

Q_u — Unconfined Compressive Strength

RE — Resident Engineer

RGR — Roadway Geotechnical Report

R.O.W. — Right-of-Way

RQD — Rock Quality Designation

RSS — Reinforced Soil Slope

- SCP** — Static Cone Penetrometer
- SDD** — Standard Dry Density (Illinois Modified AASHTO T 99, unless otherwise specified)
- SEP** — Subsurface Exploration Plan
- SGR** — Structure Geotechnical Report
- SIMS** — Structures Information Management System
- SL** — Shrinkage Limit
- SPT** — Standard Penetration Test
- SPZ** — Seismic Performance Zone
- SRICOS** — Scour Rate In COhesive Soils
- SSC** — State Soils Committee
- SSM** — Subgrade Stability Manual
- SSR** — Subgrade Support Rating
- Standard Specifications** — (IDOT) Standard Specifications for Road and Bridge Construction
- STTP** — Specific Task Training Program
- TDR** — Time Domain Reflectometry
- TRB** — Transportation Research Board
- tsf** — Tons per Square Foot
- TSL** — Type, Size, and Location plan
- USDA/NRCS** — United States Department of Agriculture/Natural Resources Conservation Service
- USGS** — United States Geological Survey
- WEAP** — Wave Equation Analysis of Pile driving
- WSDOT** — Washington State Department of Transportation
- WSS** — Web Soil Survey

Descriptions

The following common and miscellaneous soil descriptions are for information only:

COMMON SOIL DESCRIPTIONS

SiL	=	Silty Loam
SiC	=	Silty Clay
CL	=	Clay Loam
Sa	=	Sand
SiCL	=	Silty Clay Loam
C	=	Clay
L	=	Loam
SaL	=	Sandy Loam
SaC	=	Sandy Clay
SaCL	=	Sandy Clay Loam
Si	=	Silt
Peat	=	Peat

MISCELLANEOUS SOIL DESCRIPTIONS

Alternating Layers
Blocky Structured
Calcareous
Coarse Sand
Crumbly
Fine Sand
Laminated

Marbled
Mottled
Organic
Oxidized
Peaty
Pockets

Sand Lenses
Seams
Secondary Structured
Slickensided
Streaks
Till

This page left intentionally blank.

Chapter 1 General, Organization and Administration

1.1 General

The geotechnical practices and procedures presented herein constitute the Illinois Department of Transportation's (IDOT) policies for planning, designing, constructing, and maintaining geotechnical features of the roadways, structures, and overall roadway corridors. Users of this manual shall strive to provide safe, cost-effective transportation infrastructure for Illinois that enhances the quality of life, promotes economic prosperity, and demonstrates respect for the environment.

For many of the Department's projects, geotechnical engineering has an integral role throughout the planning, design, and construction phases. The chapters of this manual follow the same order as the overall project development phases from planning, through design, and construction. In addition, this manual discusses the components of developing typical geotechnical projects in order of logical progression from initiation to completion.

Chapter 1 outlines the Department's geotechnical engineering organizational structure, responsibilities, and consultant firm usage. In addition, the last section of this chapter summarizes other Departmental resources which are used in conjunction with this manual. These include memorandums, design guides, training courses, and other documents developed by the Department to offer guidance on design and policy implementation, as well as, facilitating consistency among the various personnel performing geotechnical engineering services.

1.2 State Geotechnical Organization and Responsibilities

The Department's geotechnical engineering functions are handled through a decentralized organizational structure which requires joint coordination effort between multiple offices within IDOT. Each of the Department's nine districts has a Geotechnical Unit, and the Central Office divides its geotechnical responsibilities between two separate units. One of the Central Office units is located in the bureau of Materials herein referred to as the Central Bureau of Materials (CBM), and the other is located in the Bureau of Bridges and Structures (BBS).

Geotechnical Manual

Chapter 1 General, Organization and Administration

The districts conduct the frontline geotechnical engineering operations while the Central Office provides engineering, review and supportive services. Additionally, the Central Office coordinates statewide geotechnical engineering activities which include research and development of policies and procedures. A chart outlining the Department's geotechnical engineering organization is shown in [Figure 1.2-1](#).

The district Geotechnical Units operate under the Materials Section in the district's bureau of Project Implementation. Each unit's primary responsibilities include:

- Conducting and overseeing geotechnical studies consisting of project scoping, subsurface explorations, laboratory testing, geotechnical engineering analyses, and development of geotechnical reports;
- Conducting special forensic investigations and assisting in developing repairs for issues such as slope failures, ground subsidence, and sink holes;
- Participating in statewide research and policy development processes in coordination with the Central Office;
- Developing District and Project Specific Special Provisions;
- Providing technical design assistance and review of Phase I and II planning reports and design plans;
- Performing and reviewing construction materials testing and inspection of geotechnical features;
- District wide oversight for regulatory compliance of the Department's license for operating its nuclear density gauges;
- Archival management of the District's geotechnical reports, test results, and data;
- Performing evaluations of geotechnical consultant performance.

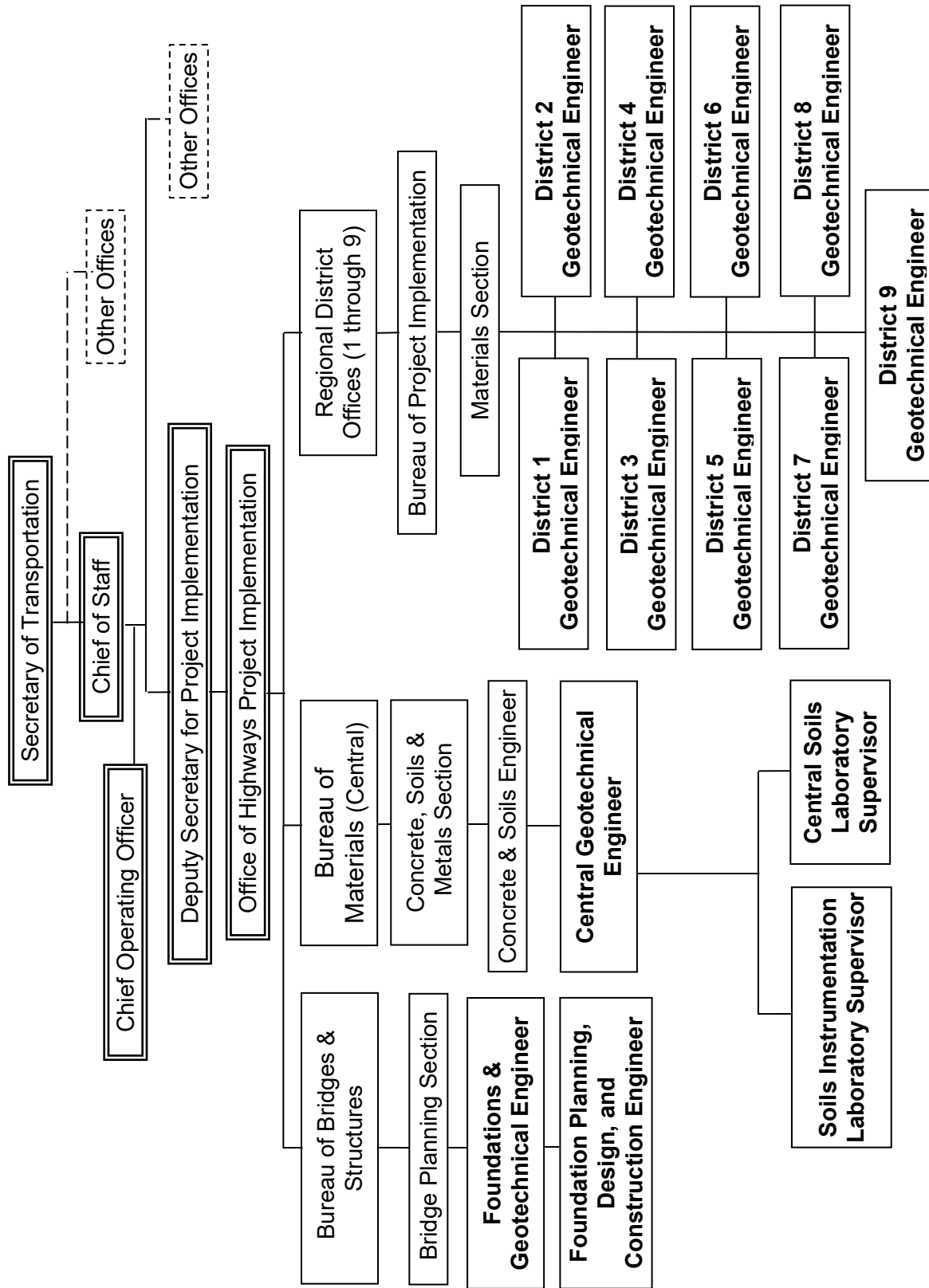

Figure 1.2-1 IDOT Geotechnical Engineering Organizational Chart

Geotechnical Manual

Chapter 1 General, Organization and Administration

The Central Bureau of Materials houses the Central Office (State) Geotechnical Engineer and staff within the Concrete and Soils Unit (CSU) of the bureau's Material Testing Section. The Central Soils Testing Laboratory and Soils Instrumentation Laboratory are located within this unit as well. The primary geotechnical responsibilities of this unit include:

- Coordination between the Central Office and the Districts to develop, maintain, and administer statewide Departmental geotechnical engineering policies, specifications, and research;
- Investigating and implementing revisions to manuals, specifications, and policies;
- Conducting special engineering studies and reports;
- Conducting and assisting in forensic investigations, such as ground subsidence and repairs for slope failures;
- Performing several soil tests not available in many of the districts;
- Providing technical assistance to Districts including reviewing or conducting geotechnical engineering analyses, designs, and providing guidance on construction challenges;
- Reviewing Preliminary Feasibility, Corridor, Roadway and other Geotechnical Reports and memoranda as required;
- Reviewing District construction submittals such as value engineering, special ground improvement, and construction problems;
- Reviewing and/or evaluating new and existing geotechnical software for potential Department wide use;
- Providing Specific Task Training Program (STTP) courses for soils field testing and inspection to state, local agency, and consultant personnel;
- Statewide oversight for regulatory compliance of the Department's license for operating its nuclear density gauges;
- Calibration and repair of some Department owned soil testing equipment such a nuclear density gauges;
- Geotechnical consultant prequalification assessment.

Geotechnical Manual

Chapter 1 General, Organization and Administration

Within the Bureau of Bridges and Structures resides the Foundations and Geotechnical Unit (FGU). The FGU's main responsibilities include:

- Reviewing and approving Structure Geotechnical Reports and other related reports and memoranda, as required;
- Reviewing geotechnical aspects of Type, Size, and Location Plans (TSL), and final design and contact documents;
- Reviewing District construction submittals including MSE internal stability, ground anchors, soil nail walls, temporary sheeting, cofferdams/seal coats, value engineering, sound barrier foundations, aggregate column ground improvement, reinforced slopes, and construction problems;
- Assisting district Geotechnical Units when requested;
- Conducting forensic investigations; and foundation underpinning, repairs and slope failure retrofit designs;
- Providing STTP Program courses for drilled shaft and pile foundation construction inspection to state, local agency, and consultant personnel;
- Providing updates and improvements to the foundations and structure-geotechnical related portions of the *Geotechnical Manual* and the [Bridge Manual](#);
- Developing and maintaining the design tables, base sheets, and software for foundation selection for high mast lighting, traffic signals mast arms, overhead sign structures, noise abatement walls and other structures;
- Developing and maintaining geotechnical specifications related to bridges and walls contained in [Guide Bridge Special Provisions](#) (GBSP) or the [Standard Specifications for Road and Bridge Construction](#) (Standard Specifications);
- Developing and overseeing research on geotechnical issues impacting bridges, walls, culverts and other structures;
- Developing spreadsheet software for geotechnical analysis, and evaluating commercial software for potential statewide use;
- Assisting CBM in geotechnical consultant prequalification when requested.

Geotechnical Manual

Chapter 1 General, Organization and Administration

Some primary responsibilities are jointly shared by the Central Office CSU and FGU. These include:

- Participating in research and coordination with other state DOT, FHWA, AASHTO, TRB, NHI, academia, and other state and national organizations in order to develop and improve geotechnical engineering policies and practices and to stay abreast of new publications;
- Technology transfer by facilitating and organizing seminars, attending conferences, and disseminating innovative research findings to Departmental geotechnical engineering personnel;
- Developing a statewide geotechnical data management system in coordination with the Districts.

1.3 Geotechnical Engineering Consultant Firm Usage

In order to accomplish the Transportation Improvement Program, the Department uses outside consulting firms when necessary to supplement IDOT personnel and perform specialized services if the Department does not have in-house capabilities. Consultant firms performing geotechnical engineering services for the Department are required to be prequalified in the appropriate geotechnical services category for the work being performed. The Department prequalifies geotechnical consultants to perform work in the following four categories:

- Geotechnical Services: Subsurface Explorations
- Geotechnical Services: General Geotechnical Services
- Geotechnical Services: Structure Geotechnical Reports (SGR)
- Geotechnical Services: Complex Geotechnical / Major Foundations

The prequalification categories differentiate between the various types and levels of geotechnical service utilized by the Department. Each prequalification category has difference minimum requirements for staffing, expertise, experience, professional engineering licensure, equipment, and facilities. Category descriptions and minimum requirements for prequalification in each of these categories are available on the Department website: <http://www.idot.illinois.gov/> in IDOT's [Description and Minimum Requirements for Prequalification](#) publication (located under the "Prequalification" drop-down tab).

Geotechnical Manual

Chapter 1 General, Organization and Administration

To maintain prequalification, firms are routinely reviewed by subject matter experts in the Central Office for each category to monitor and assess changes in the firm's staffing, experience, etc. The Districts and Central Office bureaus overseeing consultant contracts also conduct an evaluation process to assess the work performance of consultant firms. More information on Departmental administration of consultant firms is discussed in Chapter 8 of the [*Bureau of Design and Environment \(BDE\) Manual*](#).

1.4 Other Geotechnical Resources Documents

The most current manuals and information related to geotechnical policies, documents, and procedures are available on IDOT's website <http://www.idot.illinois.gov/>. The following is an abbreviated list of geotechnical memoranda and other supplemental electronic documents available on the Department's website. These and other available documents are dated and revised as IDOT policy, government regulations or design codes change.

1. [All Geotechnical Manual User Memoranda \(AGMU Memos\)](#)
2. Geotechnical Design Guides ([Section 6.19](#))
3. Geotechnical Design and Construction Spreadsheets ([Section 6.19](#))
4. Geotechnical Special Provisions
5. Geotechnical Forms
6. Geotechnical Training Courses and Class Reference Guides
7. [Subgrade Stability Manual](#)

[AGMU Memos](#) advise *Geotechnical Manual* users on policy changes. Typically, the policies implemented through these memos will eventually be incorporated into the manuals.

A number of Geotechnical Design Guides have been prepared to illustrate various policies and procedures and are considered companions to the *Geotechnical Manual*. In addition, several of these Design Guides are accompanied by Geotechnical Design and Construction Spreadsheets that electronically streamline calculations for the procedure or procedures described. Engineers and technicians are encouraged to use these spreadsheets for analysis, design, and inclusion in geotechnical reports when applicable. Some spreadsheets are also available to assist with construction inspection.

Geotechnical Manual

Chapter 1 General, Organization and Administration

These documents are in several locations throughout the Department's website, and direct links to lists for most of these documents are not available given the website's architectural format. Website navigational tutorials are available in the website's "Help" link <http://www.idot.illinois.gov/home/help>. However, most of the geotechnical engineering documents can be located by visiting two main areas on the website:

- **Soils/Geotechnical page:** The website navigational path to this location is [Home > Doing Business > Material Approvals > Soils](#). On this page, the various electronic documents can be located through selecting the tabs, such as "Procedures" and "References" located near the middle of the page. From there, the information is listed under the various drop-down list buttons.
- **Foundations & Geotechnical listings:** The website navigational path to this location is [Home > Doing Business > Procurements > Engineering, Architectural & Professional Services > Consultant Resources](#). On this page, select the "Bridges & Structures" tab located near the middle of the page, and then the information is listed under the "Foundations & Geotechnical" drop-down button located about half-way down the "Specific Scope of Services" list.

A [Geotechnical Subscription Service](#) is available to inform subscribers of changes and updates to geotechnical policies and information on the website. Users of the *Geotechnical Manual* should subscribe to this service to stay advised of policy revisions and other pertinent changes.

Chapter 2 Geotechnical Studies Overview

2.1 Introduction

This chapter presents an overview of the various geotechnical studies conducted by the Department, as well as, their integration into the overall project development process. The last section of this chapter also provides a summary of the typical development process for geotechnical studies.

2.2 Geotechnical Engineering Tasks in Planning, Design, and Construction Phases

The State of Illinois spans a distance of about 210 miles from east to west and about 390 miles from north to south. Across this distance, a wide range of geological features exist. Geotechnical engineering evaluates the soil and rock properties of the geologic material within the project limits for use in supporting roadways and structures. The goal of evaluating subsurface conditions is to identify and utilize the site's geologic material to its potential while mitigating weaker and/or unsuitable materials. This task is one of the most challenging design aspects compared to utilization of most other construction materials employed in a project. Successful accomplishment of it contributes to having a safe, cost-effective, functional and durable infrastructure.

2.2.1 Planning and Design Phases

For many of the Department's projects, geotechnical engineering has an integral role throughout the planning, design, and construction phases. Chapters 2 and 3 in the [Bureau of Design and Environment Manual](#) outline the overall project development processes for improvements to new and existing alignments including when geotechnical engineering is integrated into the processes. Generally, geotechnical studies are conducted either near the completion of a Phase I study or shortly after the Phase II design has begun.

The geotechnical project planning process is typically initiated through coordination between the district's bureau of Program Development and the District Geotechnical Engineer (DGE), where the scope of the Phase I/II design project is reviewed. From there, the DGE typically develops a

general geotechnical scope-of-work that identifies the need and type of subsurface exploration, laboratory testing, analysis, and reporting. Once the geotechnical study is underway, the information from the field and laboratory tests is evaluated and analyzed with the results and recommendations compiled in a Geotechnical Report.

After the initial study and Geotechnical Report are completed, additional coordination may need to follow. This may include follow up communications between the geotechnical engineer(s) and the roadway designer(s) or structural engineer(s) to assist in interpreting and applying recommendations or results contained in the Geotechnical Report.

Following completion of the Geotechnical Report, additional geotechnical engineering involvement may be needed because of the timing of the initial geotechnical work within the development of the overall project. Geotechnical Reports are frequently prepared in the early stages of the design process, and it is possible from time to time during the Phase II design process for issues or plan changes to be identified that were not apparent during Phase I. These changes may result in the need for additional geotechnical engineering analysis and potentially additional field exploration and/or testing. When geotechnical recommendations and/or test data are transmitted to the designer after completion of the Geotechnical Report, they should be documented using a revised Geotechnical Report, an addendum supplemental report, or Geotechnical Design Memorandum as appropriate and following the reporting guidelines in [Chapter 7](#).

Phase II design is also when any special provisions (such as special instrumentation monitoring, special material requirements, specialized ground improvement, etc.) are identified and developed for incorporation to the contract bid documents. Some of these special provisions may be readily available as [Bureau of Design and Environment Special Provisions](#), [Guide Bridge Special Provisions](#), or District Special Provisions. Other special provisions are developed specifically for the project and require review by the DGE, CSU, and/or FGU during the Phase II plan review process. Refer to [Section 6.16](#) for further guidance on Contract Special Provisions.

2.2.2 Construction Phase

Phase III (construction phase) involves several geotechnical engineering activities. Material quality compliance oversight is one of the key activities. Each district's Materials Section is responsible for testing and inspection of construction materials to determine compliance with project specifications, which include materials for geotechnical features such as embankments and subgrades. Some items of work, such as borrow source materials, are required to be submitted by the contractor during the construction phase for material approval by the district Geotechnical Unit.

Another Phase III geotechnical activity is the review of contractor designed structural features, such as temporary soil retention systems. These items are submitted to the Bureau of Bridges and Structures where the Foundations and Geotechnical Unit provides the review and approval.

During the construction of a project, there are, from time to time, problematic occurrences such as design errors, plan omissions, and variances in anticipated field conditions. If the problems are earthwork related, the district Geotechnical Unit frequently assists the Construction Section in addressing these problems. When they are related to foundations, retaining walls, or other geotechnical structural elements, the Foundations and Geotechnical Unit in the Bureau of Bridges and Structures may be called for assistance.

2.3 Types of Studies

Several types of geotechnical studies are conducted at various stages of a project and throughout the life of a roadway. For a new roadway alignment, Corridor and Feasibility Geotechnical Studies may be conducted to provide valuable information for use in the corridor selection process and developing the new roadway alignment. As Phase I and II design studies for new and existing alignments are underway, roadway and structure geotechnical studies are conducted to facilitate development of the design and construction details. Then, during the operational life of the roadway, there may be unforeseen events impacting the safety and serviceability of a roadway corridor, such as a slope failure, which may require a special investigations study. A variety of other miscellaneous work that does not require full geotechnical reports or utilizes specialized reports is also classified under the Special Investigations category. The following sub-sections provide a brief overview of each of the main types of geotechnical studies utilized by the Department.

2.3.1 Corridor and Feasibility Geotechnical Studies

Phase I Corridor and Feasibility Studies for new alignments of major highway facilities typically include consideration of geologic conditions in the evaluation process. The purpose of this effort is to assess potential obstacles or constraints that could affect the alignment selection or feasibility of a localized improvement. This is accomplished by compiling a general summary of the area's geology, pedology, and other engineering information through review of available literature and existing documents, field reconnaissance, and limited field explorations along with material tests. The breadth of these preliminary geotechnical studies depends upon the scope, geology, topography and geography of the project, and shall be coordinated by or with the DGE on a project-by-project basis once preliminary corridors or alignments have been established. The findings from a corridor or preliminary feasibility geotechnical study are summarized in either a Corridor Geotechnical Report or Preliminary Feasibility Geotechnical Report and submitted to the district's bureau of Program Development, Studies and Plans Section for inclusion in the Corridor Report or Feasibility Study as applicable. The reporting requirements for Corridor Geotechnical Reports or Preliminary Feasibility Geotechnical Reports are discussed in [Section 7.2](#).

2.3.2 Design Phase Geotechnical Studies

There are two main types of geotechnical studies conducted for projects in the design phase. These are for roadways and structures. Many roadway improvement projects include one or more structures within the project limits. When the structure(s) within the project meet certain criteria, a separate geotechnical study is required for each individual structure. When project improvements do have separate geotechnical studies for both the roadway and structures, special attention should be exercised throughout the project development, review and coordination process to avoid conflicting recommendations in the portions of the project that overlap between the roadway embankment and the structure.

2.3.2.1 Roadways

Roadway geotechnical studies are conducted to provide information for use in the design and construction of new alignments and widening of existing alignments. These studies typically include assessments on geotechnical features such as slope stability for cuts and fills, settlement estimates for embankments, material suitability for subgrades and embankments, pavement design parameters, and ground treatment and improvement options, as applicable. Roadway geotechnical studies also include geotechnical recommendations for small structures, such as culverts, which do not require separate reports and design. Criteria for determining the need to conduct a roadway geotechnical design study is outlined in [Section 7.3.1](#) along with the type of reporting requirements for Roadway Geotechnical Reports (RGRs). Exploration requirements for roadway subgrades, cuts and fills are also presented in [Sections 3.4.1](#) and [3.4.2](#).

2.3.2.2 Structures

Structure geotechnical studies are performed to estimate the capacity of shallow and deep foundations and provide information for use in the design and construction of box culverts, bridges, retaining walls, and other structures. The Department has multiple categories of Structure Geotechnical Reports (SGRs) that are a function of the complexity of the project. Descriptions and criteria for determining which category is applicable to a project, as well as the required type of reporting for each category, are discussed in [Section 7.4.1](#). The exploration requirements for structures are also dependent upon the particular structural component and are presented in [Section 3.4.3](#).

2.3.3 Special Investigations

Special Investigations are conducted for projects that lie outside of a routine scope of a typical Roadway or Structure Geotechnical Design Study. They can range from basic soil borings to in depth studies. Topics include borings for traffic and sign structures, Shelby tube borings, bedrock soundings and coring, peat soundings, groundwater elevation observations, long-term monitoring of known problem areas, detention ponds and wetlands, borrow pits, and geotechnical studies for pavement rubblization projects. Some of these categories such as Shelby tube borings and peat or rock sounding may be incorporated into an RGR or SGR to address localized conditions. Other categories such as traffic and sign structure borings are processed by the Department separately from other design elements and as such do not require full geotechnical reports. Geotechnical

studies for pavement rubblization projects are a specialized study and report ([Section 7.5.1](#)) that is focused on the feasibility of successfully performing pavement rubblization.

Special Investigations also cover unforeseen events which may occur during the operational life of the roadway and affect the roadway's safety and serviceability. Examples include slope failures, mine subsidence, and sink holes. A Special Investigation is utilized to evaluate the source of the problem and develop mitigation options.

Guidance on exploration requirements for various Special Investigation categories are provided in [Section 3.4.4](#).

2.4 Project Development Process

The process of conducting a geotechnical study is qualitatively similar for most projects. Chapters 3 through 7 of this Manual have been organized to follow the general progression for completing a geotechnical study as outlined below:

- **Identification**: The need to conduct a geotechnical study is typically identified through one of two paths. The most common means of identification is through the Phase I or Phase II project development process by the district's bureau of Program Development. Once the need is identified, the geotechnical study is initiated through coordination between Program Development and the DGE.

The alternative process for identifying the need for a geotechnical study is when the district bureau of Operations notifies the DGE of a problem observed during maintenance surveillance and/or operations. These notifications may lead to the initiation of a Special Investigations study.

- **Reconnaissance and Scoping**: Reconnaissance and scoping are inherently integral and iterative processes. After the need for a geotechnical study has been identified for a Phase I/II design project, the DGE reviews the scope of proposed improvement and available site information to assess the type of geotechnical study(ies) needed, identify the general scope-of-work required for compliance with Departmental policies, and address any readily identified special site conditions. Guidance on project reconnaissance and scoping is provided in [Chapter 3](#).

For a Special Investigations study, the process may begin with field reconnaissance to assess the extent and urgency of the reported problem. This includes consideration to functionality of the roadway, potential risk for property damage, and general public safety. Once the initial field condition information has been obtained, the DGE determines if a Special Investigation study is warranted or if it is a routine maintenance repair. If warranted, the project is then prioritized and coordinated with other bureaus.

- **Data Acquisition:** Data acquisition consists of gathering both existing and new information for a particular project. This process begins during the project scoping with reconnaissance of the project area, where existing information is used to assess the amount and type of new data required for the geotechnical study. Examples of existing data sources include existing plans, historical reports, literature review, and remote sensing. [Chapter 3](#) provides information on common data acquisition resources used in geotechnical studies.

Most of the new data is typically obtained from a subsurface exploration program consisting of field testing, sampling, and subsequent laboratory testing to characterize the subsurface conditions and identify material properties. Collecting field data can be costly and time consuming. Obtaining field data too early in the development of a project may result in having to redo the field work if there is a change in the proposed roadway alignment. Unless field data is needed to assist with the final alignment selection process, it is generally recommended that subsurface explorations for design phase geotechnical studies do not proceed until after the final horizontal and vertical alignment is determined during Phase I Design Study of a project. Additionally, subsurface field explorations for structures should not proceed until the preliminary substructure/foundation locations have identified. Refer to [Chapter 4](#) for discussion on the development of Subsurface Exploration Plans (SEPs) and performing field explorations, sampling, and field testing. Refer to [Chapter 5](#) for information on laboratory testing of field samples.

- **Analysis and Recommendations:** Once the data has been collected, the geotechnical study transitions into the evaluation and analyses of the data to formulate recommendations for use in the plan design and project construction. The level and detail of the analyses and evaluations will vary, as appropriate, between projects and will depend on the proposed improvement and site conditions. The results of the analyses and evaluations are used to formulate recommendations that contribute to developing safe, cost effective, functional, and

durable transportation facilities. [Chapter 6](#) provides guidance on analyzing the project data and developing design recommendations.

- **Reporting:** The findings of geotechnical studies are documented through the development of reports. Geotechnical Reports compile and summarize the project data and subsurface conditions. They also present results of analyses and convey recommendations from geotechnical studies to the designers for use in design and development of final plans, specifications, and cost estimate (PS&E) documents. Refer to [Chapter 7](#) for guidance on the format and content of Geotechnical Reports.

Chapter 3 Reconnaissance and Project Scoping

3.1 Introduction

After initially identifying the need for a geotechnical study, the next step is to perform reconnaissance and project scoping. The two are inherently integral and iterative, where existing data is gathered and reviewed to develop the project scope. Chapter 3 discusses the reconnaissance process for a project and its use in developing the initial scope of the geotechnical study. This process generally follows AASHTO R 13, “Standard Practice for Conducting Geotechnical Subsurface Investigations”.

This chapter also outlines the Department’s minimum field exploration requirements for conducting Design Phase Geotechnical Studies (for RGRs and SGRs) and some types of Special Investigations. The type and extent of field exploration for Preliminary Feasibility, Corridor, and some Special Investigation geotechnical studies need to be customized for each individual project and are subject to development and approval by the DGE. The last section of this chapter provides guidance on the Department’s standard practice for field and laboratory testing of soils samples for routine geotechnical studies.

3.2 Reconnaissance of Project Area

Project scoping for geotechnical studies and field subsurface exploration programs are facilitated first by performing reconnaissance of the project area. Reconnaissance consists of gathering and reviewing available information about the proposed project improvement, available technical data for the proposed project area, as well as a site visit. This information is used for developing the project scope as well as formulating geotechnical design recommendations. Proposed project improvement information is typically obtained from Phase I reports, such as a Project Report, and/or preliminary plans. Sources of existing geotechnical data include published literature, Departmental records, and other communications regarding the geology, topography, existing land use, and groundwater conditions anticipated to be encountered at the site. This chapter discusses the sources most frequently referenced by the Department for geotechnical studies,

Geotechnical Manual

Chapter 3 Reconnaissance and Project Scoping

and other resources may be utilized when applicable to a project. It is the responsibility of the users of this Manual to determine which sources are pertinent to the scope of a particular project.

The review of existing geotechnical data for a proposed project area should be supplemented by a site visit for ground reconnaissance to identify any potential geotechnical concerns to include in the project scope. Ground reconnaissance is also important for scoping the mobilization of subsurface exploration equipment and field personnel. On-site observations are valuable for evaluating site access conditions and constraints such as rock out crops, steep slopes, soft ground surface conditions, potential for the presence of any buried hazardous materials, ground cover, utilities, traffic, and working room.

3.2.1 Proposed Project Improvement Information

The first source of information to gather and review in the reconnaissance and scoping process is information on the proposed improvement. This includes the location and type of project. This information is then used to determine the type(s) of geotechnical study(ies) and focus the reconnaissance process to obtain information that will be the most pertinent in scoping, engineering evaluations and analyses, and development of recommendations. Depending on the type of improvement, typical sources of information on the proposed improvement include Phase I reports and preliminary plans. These documents contain information on the existing and proposed plan and profiles, existing and proposed cross sections, and survey control information. For projects with proposed structure improvements, other informational sources may include TSLs, Bridge Condition Reports, preliminary structure layout sketches, and Hydraulic Reports.

3.2.2 Literature Review

Sources of available technical data from published literature covering the proposed project area include, but are not limited to: topographic maps, aerial photography, satellite imagery, geologic maps, statewide or county soil surveys and mineral resource surveys, and climatological records. Reports of other pertinent subsurface explorations of nearby or adjacent projects should also be reviewed if available.

Geotechnical Manual

Chapter 3 Reconnaissance and Project Scoping

Illinois has several organizations which have published geological, agricultural, and water surveys for many years. These publications provide a wealth of technical data for nearly every part of the State. These include water well drilling records, USDA/NRCS reports, pedologic maps, quaternary deposits maps, and bedrock surface maps. A partial listing of many of these publications is included in the Bibliography in [Appendix F](#).

3.2.2.1 Aerial Photography

Considerable information can be deduced by proper interpretation of aerial photographs. Aerial photographs are advantageous in site reconnaissance because they provide a broad view of a site and are an ideal base for recording planimetric information obtained during the field survey. They can also reveal features that may not be readily recognizable at the ground level such as old meander scars in an alluviated valley. Thus, these photographs may assist in scoping the field exploration program by indicating areas of possible concern.

Obtaining aerial photographs of a site at a scale of 1"=1,600 ft. or larger are recommended. The Department's Aerial Surveys Section in BDE typically has photographs available at scales of 1" = 800 ft. or larger. The project designers may have aerial photos overlaid with a plot of the proposed improvements. Recently, the computer aided drafting and design (CADD) software GEOPAK utilized by the Department was enhanced and has the capability to overlay a project plan view onto the Google Earth internet application. Aerial photographs are also readily available to the general public through sources such as the United States Department of Agriculture/Natural Resources Conservation Service (USDA/NRCS), available at <https://websoilsurvey.nrcs.usda.gov/app/HomePage.htm>. Additionally, both IDOT and USDA/NRCS photographs can be utilized for stereoscopic (3D) viewing of the site.

3.2.2.2 Topographic and LiDAR Maps

There are various sources of topographic data that can be utilized in a geotechnical study. The selection of the source depends on availability and the level of accuracy the data needs to be for a particular application. Websites such as the United State Geological Survey <https://www.usgs.gov/> and the Illinois State Geological Survey's (ISGS) [Illinois Geospatial Data Clearinghouse](#) provide topographic map downloads. The United States Geological Survey

Geotechnical Manual

Chapter 3 Reconnaissance and Project Scoping

(USGS) topographic maps are a common reconnaissance resource for project scoping, preparation of an SEP, and documenting the project site location in a Geotechnical Report. For more precise data, many proposed improvements have project specific aerial and topographic survey data obtained during the early planning phases of a project.

Topographic maps provide information on the overall ground surface topography, including drainage patterns, slope inclinations, and potential wetlands. When topographic maps are used in conjunction with aerial photos, pertinent geologic features can sometimes be identified. This data may be valuable in determining accessibility for field equipment and identifying potential geotechnically problematic areas.

As an additional resource, Light Detection and Ranging (LiDAR) surface topographic data and maps have been under recent development and may also be used to assess site geography. They typically have higher resolution than traditional USGS topographic maps, and they may provide information that is superior to aerial photographs in identifying geologic, pedologic, and historic features. Several software programs are available for reading LiDAR data files and generating digital surface and terrain models for a site. LiDAR data files are readily available for some counties and are publicly available for download from the ISGS [Illinois Geospatial Data Clearinghouse](#) or USGS's EarthExplorer website (<https://earthexplorer.usgs.gov/>). Several LiDAR surveys have also been conducted by IDOT throughout the state, and they could also be utilized if available for the project area.

3.2.2.3 Geology and Pedology

Information on the general geology and pedology of a project location can give indications of the anticipated soil and/or rock conditions at the site for use in project scoping and evaluation. This includes major geologic processes that have affected the project site, as well as the presence of particular landforms. Examples of common soil deposits in this state include alluvium, glacial outwash, loess, and tills. Alluvial deposits are delivered by rivers and streams, and they are typically silts and sands. Glacial outwash areas may range from channelized sand and gravel deposits to cobbles and boulders. Loess materials are predominately silts deposited by wind, while tills are a mixture of clays, silts, sands and pieces of rock deposited by glaciers. For quick reference, [Appendix A](#) of this Manual provides an overview of the state's geology and pedology,

Geotechnical Manual

Chapter 3 Reconnaissance and Project Scoping

and the following sub-sections discuss other commonly accessed sources of geological and pedological data. A report by Thornburn (1963) can also be used to obtain information on the surface deposits of Illinois.

3.2.2.3.1 ISGS Information

The Illinois State Geological Survey (ISGS) is a source of a wide variety of books, maps, and other published literature frequently referenced for geotechnical studies. The ISGS resources include information on geologic mapping, water wells, coal mines, oil and gas well records, and other records. These documents show much of the Pleistocene deposits, as well as bedrock features which have been covered by this period of glacial activity. A thorough search of the site's geologic data may provide an idea of the variety of deposits which may be encountered during a subsurface exploration program. In addition, a review of the oil and gas maps, mined-out area maps, and coal reserve maps may also give an indication of areas of potential concern.

Many of these documents and other interactive databases such as the [Public Land Survey System](#) (PLSS) are available electronically on ISGS's website (<https://isgs.illinois.edu>). The ISGS website also contains the [Illinois Geospatial Data Clearinghouse](#) with downloadable files available for aerial photography, USGS topographic maps, GIS data, and LiDAR survey data.

3.2.2.3.2 USDA/NRCS County Soil Survey Reports

The United States Department of Agriculture (USDA), Natural Resources Conservation Service (NRCS) publishes the [Web Soil Survey](#) (WSS), available on the internet. This collection of county soil surveys is a source of pedological maps, and they typically describe the range of soil profile characteristics to depths of about 5 to 6 feet for mapped soil units. The NRCS county soil survey data is updated and maintained online. However, printed copies or compact discs (CDs) of previously published NRCS soil surveys may also be available at local county USDA offices. The [Web Soil Survey](#) is interactive and allows the user to define an area of interest, view and print a soil map, access various soil data with engineering properties, and generate detailed electronic reports of the area of interest.

Geotechnical Manual

Chapter 3 Reconnaissance and Project Scoping

The information from the WSS should not be used as a substitute for a field sampling and testing program, as a certain number of borings will be required to obtain samples for laboratory testing, classification, and verification of the anticipated soil characteristics. However, the data may be used in conjunction with engineering judgment to refine the scope of a subsurface exploration program. In locations where the WSS indicates certain problematic soil types (frost susceptible or swelling soils, peats, etc.) are to be likely encountered, the subsurface exploration program scope may focus the number and spacing of borings in a particular area, as well as, aid in selecting the type of equipment and sampling required. Additionally, the number of borings for subgrades can sometimes be reduced in areas where the pedological maps report fairly uniform soil mapping units, typically in relatively level terrain, and where moderate to deep cuts or high fills are not proposed. Refer to [Section 3.4.2](#) for more discussion on this topic.

3.2.2.4 Climatological Data

Climatological data is used when evaluating groundwater conditions. Certified climatic precipitation data can be obtained from the National Oceanic and Atmospheric Administration (NOAA) National Centers for Environmental Information (NCEI) formerly known as National Climatic Data Center (NCDC) at: <https://www.ncdc.noaa.gov/>. In addition, the following link provides access to the NCDC U.S. Local Climatological Data (LCD) website for Edited Monthly Online LCD data: <https://www.ncdc.noaa.gov/IPS/lcd/lcd.html>. Recent data can be obtained from the NOAA National Weather Service (NWS) Regional Support Center homepage websites under the observed weather preliminary monthly climate data. More local climatic data can be found on the Illinois State Climatologist Office's website at: <https://stateclimatologist.web.illinois.edu/>. Other subscription services and internet websites for climatic data are also available. The source of the data shall be referenced when used in the Geotechnical Report.

Geotechnical Manual

Chapter 3 Reconnaissance and Project Scoping

3.2.3 Departmental Records

Reconnaissance of Departmental records is useful in developing the scope of an exploration plan for refining the number, spacing, and depth of sampling locations. These resources are also utilized during analysis, evaluation and development of geotechnical design recommendations. The following list summarizes the most commonly accessed Departmental resources for geotechnical studies, and it is the responsibility of the users of this Manual to determine which sources are pertinent to the scope of a particular project:

- Phase I reports such as Project Reports, Combined Design Reports, etc.
- Proposed roadway plan and profile alignment and cross sections
- Existing and/or as-built plans
- Previous Geotechnical Reports, existing borings and test data
- Preliminary TSL drawings
- Bridge Condition Reports
- Hydraulic Reports
- Existing hydraulic and bridge inspection records
- Existing pile driving records
- Structures Information Management System (SIMS)
- Geographic information systems (GIS)
- Environmental, archeological, historical, and biological clearance records and reports

3.2.3.1 Existing Plans

Many projects are either on or near existing alignments. As such, existing plans are typically available, and should provide insights into the subsurface conditions that are likely to be encountered at a particular site. When available, reviewing as-built plans is recommended, as they can provide information about encountered field conditions that deviated from those which were anticipated in the design phase.

Geotechnical Manual

Chapter 3 Reconnaissance and Project Scoping

3.2.3.1.1 Existing Structure Plans

Existing and as-built structure plans typically provide information on the type, size, and location of in-place foundations, and may contain boring information. When acquiring new borings, it is beneficial to know the location of existing foundations, including ones that may be abandoned and buried, in order to avoid them during drilling operations. Existing plans may also facilitate the identification of such phenomena as man-made or natural shifts in channel alignment, a channel's propensity to lateral migration, and scour.

In addition, existing structure plans typically contain details on existing pile sizes, estimated pile lengths, and pile capacity. They may also indicate maximum applied soil bearing pressure for shallow foundations, or past removal and replacement of unsuitable material. Information such as this can be used as an aid when estimating the required depth of proposed borings and in evaluating the potential for re-use of the existing foundations.

3.2.3.1.2 Existing Roadway Plans

As-built and existing roadway plans provide information on the roadway widths, thicknesses and type of existing pavement materials as well as areas of concern during past construction. They also provide information on the type, size, and location of buried appurtenances such as old pavement, utilities, and small drainage structures.

Indicators of areas of potential concern can be garnered from the summary of quantities and schedule of quantities tables for pay items like geosynthetics, aggregates, and removal and disposal of unsuitable materials. Patching areas shown on the existing or as-built plans are another possible indicator of areas where potentially problematic subgrade soils may be located. This type of information is useful in developing a field exploration program targeted towards assessing if any remedial action will be warranted on a project.

Geotechnical Manual

Chapter 3 Reconnaissance and Project Scoping

3.2.3.2 Existing Borings, Test Data, and Geotechnical Reports

Existing boring data, if available, may be adequate for use in engineering analyses in lieu of obtaining additional subsurface information on a particular project. For other projects, the subsurface information provided from existing boring data can augment new subsurface data and may be useful for developing the scope of the proposed boring locations, spacing, depths, sampling and testing for a subsurface exploration plan.

Historic and existing Geotechnical Reports document test data and recommendations for previous studies. A review of these reports may provide insights such as the likely foundation type for a proposed structure, or it may offer a correlation with a roadway's current condition. They may also provide some preliminary guidance on issues such as the need for underdrains, or extension of undercuts with a new widening project.

3.2.3.3 Existing Hydraulic and Bridge Inspection Records

Hydraulic and bridge inspection records and reports are resources for information on a site's scour potential. They may also document the presence of problems such as settlement and/or tilting of a structure, which may indicate the possibility of weak soils.

3.2.3.4 Existing Pile Driving Data

Test pile records and/or production pile driving data collected during construction of existing structures can be used when evaluating possible reuse of substructures/piling, or for estimating how deep borings should be advanced for a new foundation. The BBS or the District may have copies of these pile driving records on file.

Geotechnical Manual

Chapter 3 Reconnaissance and Project Scoping

3.2.4 Field Reconnaissance

Field reconnaissance should be conducted after the review of available information, interpretation of aerial photography and other remote sensing data, and a preliminary exploration plan has been formulated. As part of a complete subsurface exploration program, field reconnaissance is performed for identification of surficial geologic conditions, mapping of stratigraphic exposures and outcrops, examination of the performance of existing structures, observations of areas with high groundwater tables and ponding water which may affect the project alignment, and assessment of site conditions for equipment accessibility to test locations. All pertinent information including the proposed preliminary plans, topographic maps, aerial photos, and a list of potential concerns identified during remote sensing and literature review should be close at hand during the visit for comparison with actual conditions.

During the site visit, consideration should be given to the anticipated boring locations relative to the site conditions noting potential constraints such as existing drainage ways, erosion, slope conditions, foliage, rock outcrops, utilities, stream crossings, and existing structures. These items can impact the site access and equipment needs for the field exploration program. Configuration, volume of traffic, posted speed limit, and the extent of traffic control required during the exploration should also be noted. Special notes should be made of any fences, tree lines, areas of ponding water (borrow pits, wetlands, etc.), and other potential obstructions that may impede access and/or require clearing and site preparation along the alignment. This information is then used for refinement of an SEP.

Information obtained during the field reconnaissance is used in analyses and developing project recommendations. Observations from the field reconnaissance are typically documented in the Geotechnical Report, depending on the type of report. This includes discussion of site features pertinent to design and construction recommendations. Additionally, it is common practice to take photos of the site visit for future reference and inclusion in the report to support the discussion.

Geotechnical Manual

Chapter 3 Reconnaissance and Project Scoping

3.3 Project Scoping

Scoping establishes an initial plan of action for conducting a geotechnical study from the reconnaissance to report development. It begins with reviewing details of the proposed improvement and available information about the site. This information is used to assess the type of geotechnical analyses needed for formulating recommendations. Once the type of analyses and recommendations are identified, then an assessment of the data acquisition needed to perform these analyses can be completed. Much of this data acquisition is obtained through a field exploration program and laboratory testing. As such, there is subsequent scoping for the site access details to perform the field exploration. Then, a report is developed to document the components of a geotechnical study typically including a summary of the reconnaissance of available information and site visit, exploration program, field and laboratory testing, analyses, and project recommendations. Scoping of the report development is comprised from an integration of the other elements of the study.

When developing a scope for a project, a review of the applicable sections of this Manual should be conducted for each component of the study. This generally includes reconnaissance and field exploration and testing requirements ([Chapter 3](#)), developing a SEP and requirements for a conducting field exploration ([Chapter 4](#)), laboratory testing ([Chapter 5](#)), analysis and recommendations ([Chapter 6](#)), and reporting requirements ([Chapter 7](#)).

Scoping considerations shall include compliance with Departmental policies. They should also address any readily identified special site conditions noted during the initial reconnaissance of the project area.

3.3.1 Scoping Corridor and Preliminary Feasibility Geotechnical Studies

Scoping varies depending on the type of geotechnical study. Corridor Geotechnical Studies and Preliminary Feasibility Geotechnical Studies primarily focus on reconnaissance of available information from which a limited field exploration may be required. Such exploration may consist of an examination of road cuts, quarries, gravel pits, strip mines, excavations, and the performance history of existing civil works. This preliminary review of available information will often disclose areas in which one or more soil borings are essential to an understanding of the specific geologic conditions. Such borings should be made, if possible, and the results

Geotechnical Manual

Chapter 3 Reconnaissance and Project Scoping

incorporated into the Corridor Report or Feasibility Study. To aid in scoping, refer to [Section 7.2](#) for additional discussion and reporting requirements.

3.3.2 Scoping Design Phase Geotechnical Studies

Design Phase Geotechnical Studies are the most frequent type of geotechnical study conducted by the Department. This type of study(ies) may include roadway, structure(s), or combination of both roadway and structure(s) for an individual project. As such, this Manual focuses much of its discussion towards completion of these studies. For Roadway Geotechnical Studies, refer to [Section 7.3.1](#) for guidance on determining the need to conduct a study and associated reporting criteria. For Structure Geotechnical Studies, refer to [Section 7.4.1](#) for guidance on determining the need to conduct a study and associated reporting criteria.

Scoping begins with initial reconnaissance of the proposed improvement by reviewing preliminary plan details along with available site information and Department policies to identify the need and type of subsurface exploration, laboratory testing, analysis, and reporting. When reviewing the proposed improvement information, attention should be given to the proposed horizontal and vertical alignment, areas of deep cuts and high embankment construction, and the proposed structure types and locations. These features may require specific types of analyses which need to be accounted for in the scope development.

Depending on the proposed improvement, the types of analyses to assess during scoping could include suitability of on-site materials for use in construction of embankments and pavement subgrades, stability of cuts and fills, estimates of settlement, support of structure foundations, construction considerations, and control of groundwater. Once the types of analyses are identified for a project, scoping for the subsurface exploration program can be formulated. The objective of a subsurface exploration program in the design phase is to furnish accurate and complete information in order for pavements, embankments, structure foundations and retaining walls to be designed and built with safety and economy.

As a general rule, the exploratory program is typically divided into two categories: subgrade borings and structure foundation borings. Subgrade borings are drilled primarily for the design to support the pavement structure. For this purpose, intact (relatively undisturbed) or nearly

Geotechnical Manual

Chapter 3 Reconnaissance and Project Scoping

undisturbed soil samples are normally not required. Structure foundation borings are drilled for the design of bridge and other structure foundations, and these borings may also apply to areas of deep cuts and high embankments. Additionally, structure borings may extend to considerable depths in order to obtain sufficient information for design. Refer to [Section 3.4](#) for guidelines on scoping boring type, spacing, location, and depth as well as field and laboratory testing of samples.

Reconnaissance of available information regarding a site's anticipated materials and how they were generally deposited and/or formed is typically looked to for guidance in scoping a field subsurface exploration plan and project recommendations. Local geological information may aid in estimating boring depth before encountering bedrock and focusing exploration in areas that may be geotechnically problematic for the proposed improvement. It can also help in anticipating any site preparation and in selection of the type of equipment, drilling methods, and sampling techniques that may be required to complete a field exploration.

3.3.3 Scoping Special Investigation Studies

Scoping for Special Investigation Studies varies greatly depending on the subject of the study. [Section 3.4.4](#) provides discussion on the most common types of Special Investigations. Consideration should be given to the mode of reporting the study's findings, which vary from being included as part of a larger geotechnical study, a standalone report, or only boring logs or test results.

Some Special Investigations projects, such as slope failures, are oriented towards remediating operational, functional and safety issues. As such, they scope-of-work typically involves a much more in-depth field exploration and laboratory testing program to obtain sufficient data to identify the source of the problem. From there, the scope of the analyses may also be more detailed than a routine Design Geotechnical Study.

Scoping for Special Investigations, such as bedrock or peat soundings, can be difficult to estimate the extent of the field exploration and may require revisions to adequately characterize the subsurface conditions.

Geotechnical Manual

Chapter 3 Reconnaissance and Project Scoping

3.3.4 Scope Revisions

Throughout the course of a geotechnical study, it may become evident that the scope needs to be revised and/or refined to gather additional information in areas where geotechnically problematic conditions are encountered after the initial field exploration. An example of this may include activities such as delineation of peat deposits or bedrock soundings to provide more accurate estimates of treatment limits. This approach may also apply to situations where geophysical survey techniques are used to identify subsurface anomalies, like potential sinkholes, which are subsequently followed up with borings.

Occasionally changes in the project design, such as changes in alignment or structure type, will also warrant scope revisions. Depending on the extent of the changes, additional field exploration, laboratory testing, and analyses may be required. If these changes occurred after the completing on the initial geotechnical study, then this information may need to be reported revised Geotechnical Report, an addendum supplemental report, or Geotechnical Design Memorandum as appropriate.

3.4 Exploration and Testing Requirements

Exploration and testing requirements are dependent on the type of geotechnical study, proposed improvements, project specific requirements, and nature of the subsurface conditions as well as site conditions. Unless specified otherwise in the text of the following sub-sections, the boring depth and spacing requirements contained herein are intended neither as a minimum nor a maximum, but as a guide to what normally will provide sufficient information to design a project.

The project reconnaissance information, along with the sampling and testing recommendations discussed herein is used in developing the scope of the geotechnical study and a Subsurface Exploration Plan (SEP). Standard methods for conducting field and laboratory tests are described in [Chapter 4](#) and [Chapter 5](#), respectively.

Geotechnical Manual
Chapter 3 Reconnaissance and Project Scoping

3.4.1 Subgrade Borings

The locations and sampling frequencies for subgrade borings should be at such intervals as to allow the identification of all soil types, the water table elevation, and bedrock within the R.O.W. that would impact the proposed project. Also, a soils profile is required to record the subgrade boring distribution, with respect to the proposed vertical and horizontal alignment of the roadway. Refer to the flow chart in [Figure 3.4.1-1](#) for an overview of the various subgrade and embankment fill and cut conditions.

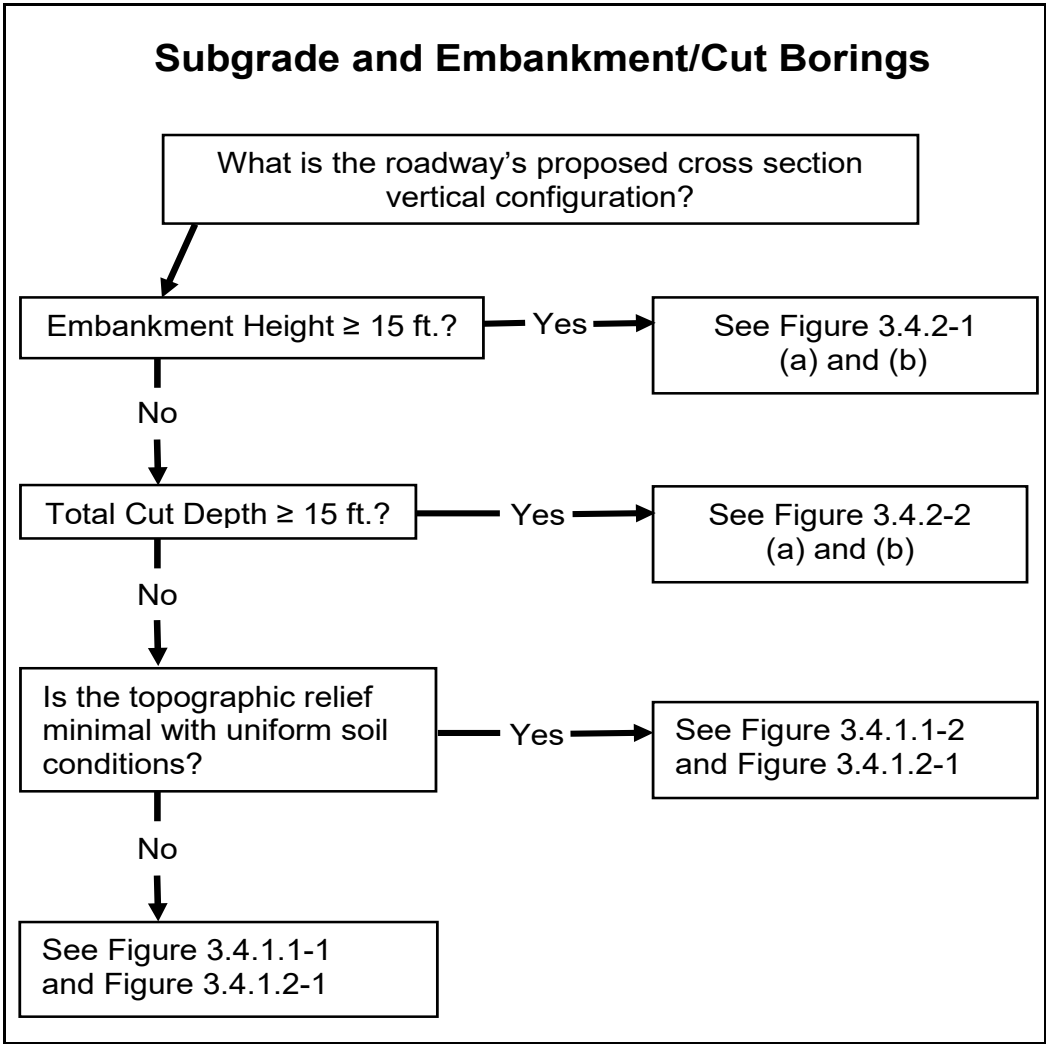

Figure 3.4.1-1 Subsurface Exploration – Subgrade and Embankment/Cut Boring Spacing and Depth Flow Chart

Geotechnical Manual
Chapter 3 Reconnaissance and Project Scoping

3.4.1.1 Spacing Requirements

In general, when deep cuts or high embankments are not anticipated, borings for a single pavement should be made at an interval of 300 ft. If more than one pavement is proposed within the R.O.W., separated by less than a 120 ft. median, boring intervals may be increased to 600 ft. along each pavement. They should be staggered at 300 ft. intervals between the two pavements. Where the pavements are separated by more than 120 ft., both pavements should be drilled at intervals of 300 ft. Refer to [Figure 3.4.1.1-1](#) for a summary of the subgrade boring spacing requirements in areas with cuts/fill less than 15 ft. in height.

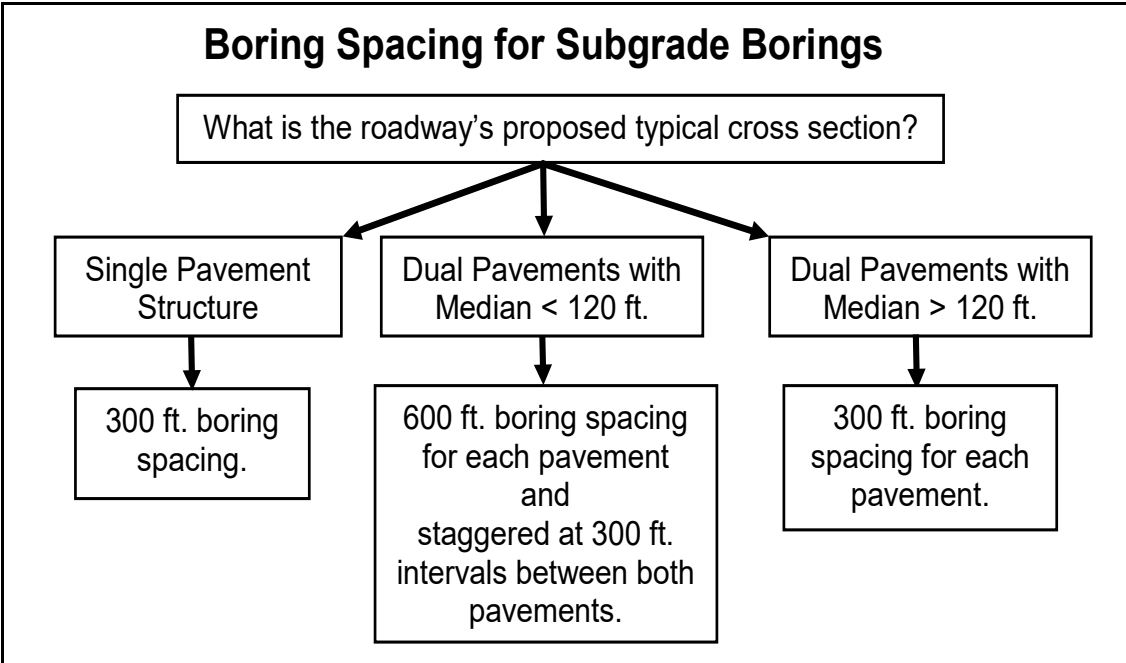

Figure 3.4.1.1-1 Boring Spacing Requirements for Subgrade Borings in areas with cuts/fills less than 15 ft. in height.

In areas of little topographic relief and when soils conditions are uniform, the boring intervals may be increased to 500 ft. along a single pavement; or up to 1,000 ft. staggered for two pavements, if separated by not more than 120 ft. In areas where the roadway will be in a cut, or a high embankment, or where a complex subsurface profile is encountered, the boring interval should be spaced more closely. Also, additional borings should be made in areas where there are transitions from one soil type to another, or when small areas of different soil types may be

Geotechnical Manual
Chapter 3 Reconnaissance and Project Scoping

encountered. Refer to [Figure 3.4.1.1-2](#) for a summary of these subgrade boring spacing requirements.

Using the aerial photographs as a guide, it is quite possible that several borings will be made in order to delineate soil boundaries from which no test samples will be taken. The principal objective remains, to correctly map the various soil types as they are encountered along the R.O.W.

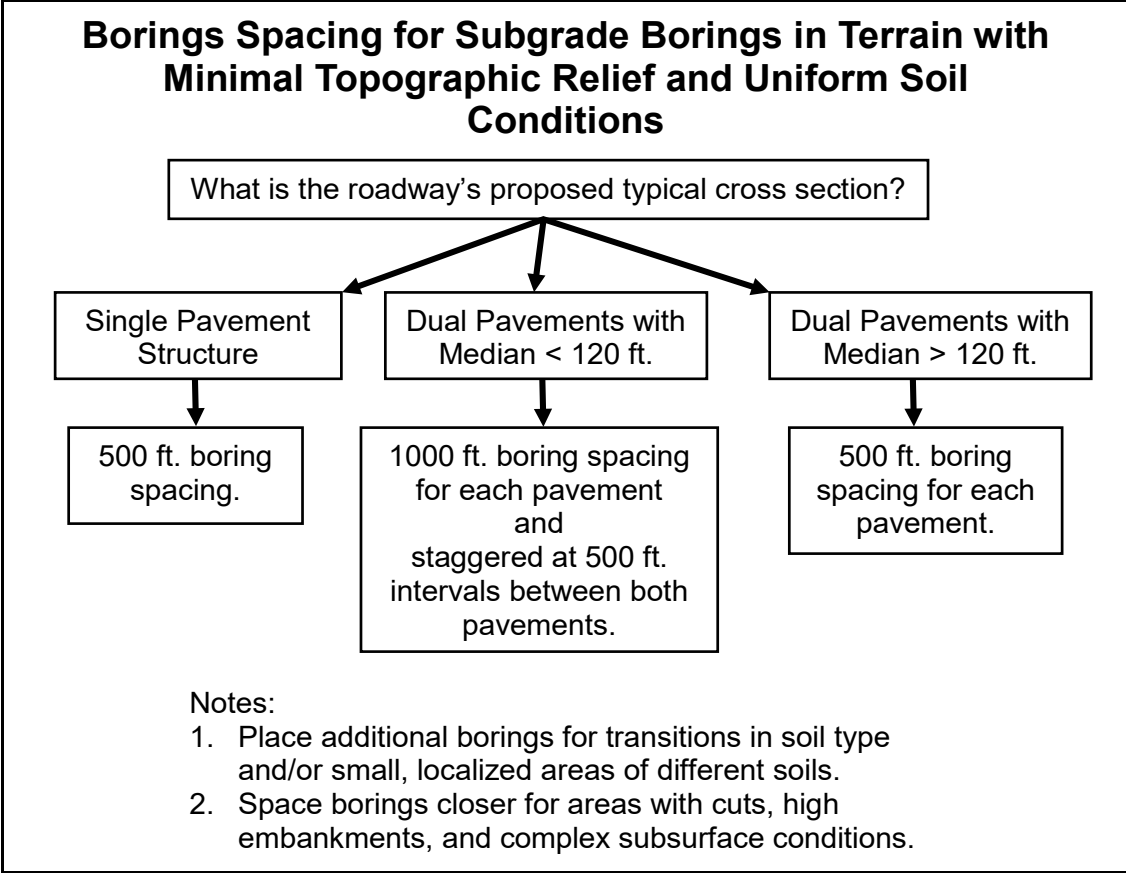

Figure 3.4.1.1-2 Boring Spacing for Subgrade Borings in Terrain with Minimal Topographic Relief and Uniform Soil Conditions

Geotechnical Manual

Chapter 3 Reconnaissance and Project Scoping

3.4.1.2 Depth Requirements

In general, borings should be deep enough to penetrate the major horizons of the soil profile. Normally, a depth of 5 to 6 ft. will be sufficient. In some cases, however, especially when the soil is composed of more than one parent material; such as, loess over glacial till or bedrock, some borings should extend at least to the contact between the two materials.

In areas where moderate cuts or fills are anticipated, the borings should penetrate a minimum of 6 ft. beneath the crown grade or elevation of the deepest excavation; or to a minimum depth of 2/3 of the height of the proposed embankment. For fill and cut areas over 15 ft., the boring depths and spacing should be according to [Section 3.4.2](#).

Refer to [Figure 3.4.1.2-1](#) for a summary of the minimum boring depths requirement on subgrade borings. This figure applies to subgrade borings in areas with cuts/fill less than 15 ft. in height.

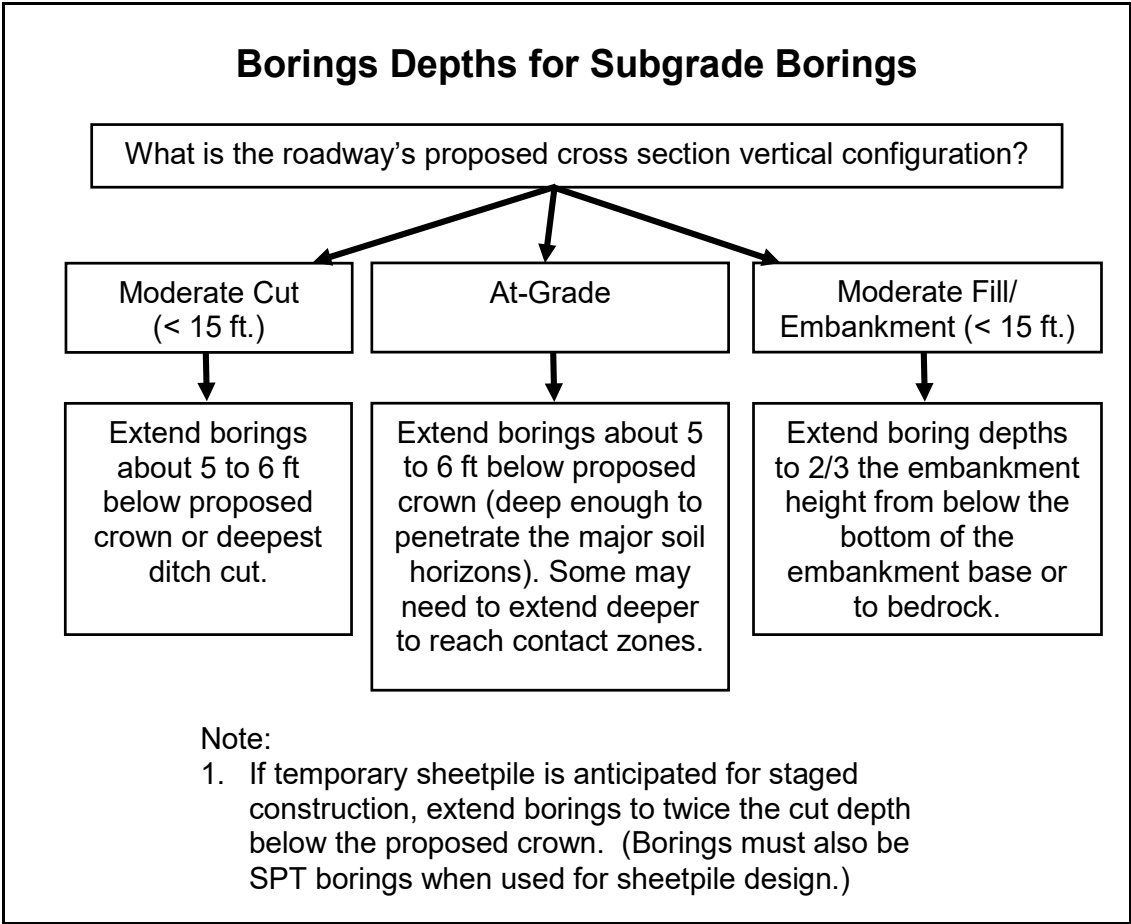

Figure 3.4.1.2-1 Minimum Boring Depth Requirements for Subgrade Borings in areas with cuts/fills less than 15 ft. in height.

3.4.1.3 Sampling Requirements

The sampling and testing requirements, as well as the type of borings, depend on the subgrade boring objectives, which should be defined by the geotechnical engineer prior to the field exploration.

For pavement design, samples from the proposed subgrade should be taken at every change in soil type or every 5 borings. They should be tested for PI, particle size, and IBR. If needed, soil should also be sampled for soil-lime (or other additive) mix design. Samples, for moisture content determination, should also be taken at the proposed subgrade, at every 2 ft. depth, and at every change in soil type.

Geotechnical Manual

Chapter 3 Reconnaissance and Project Scoping

The particle size analysis will be used in the Subgrade Support Rating (SSR) chart ([Figure 7.3.3.5-2](#)) for pavement design. Therefore, the test samples should be representative of the subgrade soil from 0 to 24 in. below the bottom of the proposed pavement.

To estimate the quantity of subgrade treatment needed, a variety of exploration methods for estimating the subgrade strength and stability have been used. These methods include: pocket penetrometer (pp) readings on the auger cuttings (in auger borings); field Q_u tests on split-spoon samples by using a Rimac spring tester; pp readings on split-spoon samples; and the DCP or SCP tests on proposed subgrade soils, in fairly shallow cut areas.

These practices appear to serve the intended purpose for this kind of exploration. However, there is not an adequate data correlation between the actual *in situ* soil strength and the pp readings on the “entirely disturbed” auger cuttings. For this reason, approval of the DGE is required for pp readings on auger cuttings.

3.4.2 Borings for Fill and Cut Areas

Areas which have a fill height or cut depth greater than or equal to 15 ft. will require slope stability analysis. The exploration program should be supplemented by stability borings, as explained in the following sub-sections. Refer to the flow chart in [Figure 3.4.1-1](#) for an overview of the various subgrade and embankment fill and cut conditions.

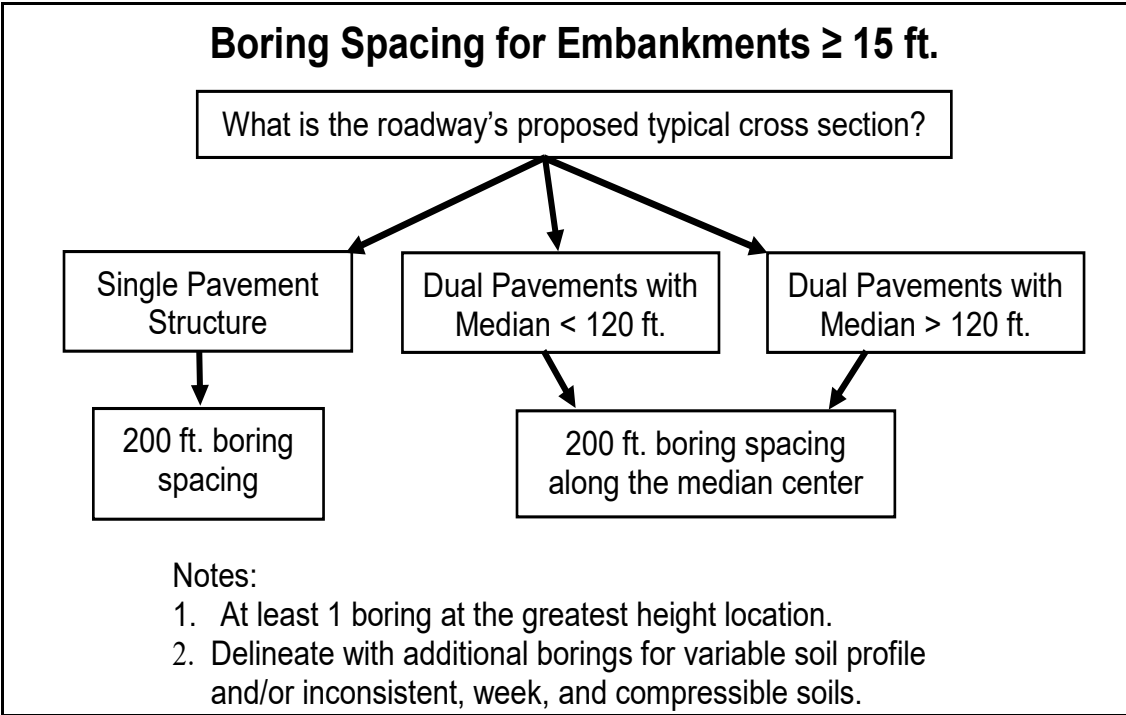

Figure 3.4.2-1(a) Boring Spacing for Embankments Greater than or equal to 15 ft.

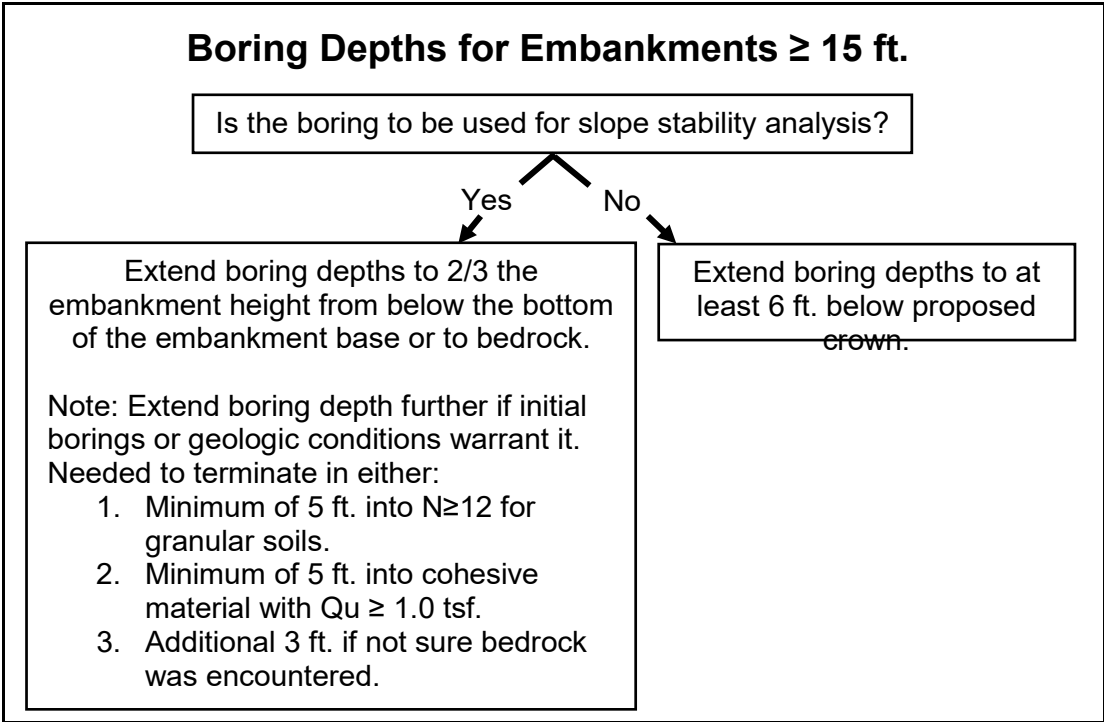

Figure 3.4.2-1(b) Minimum Boring Depths for Embankments Greater than or equal to 15 ft.

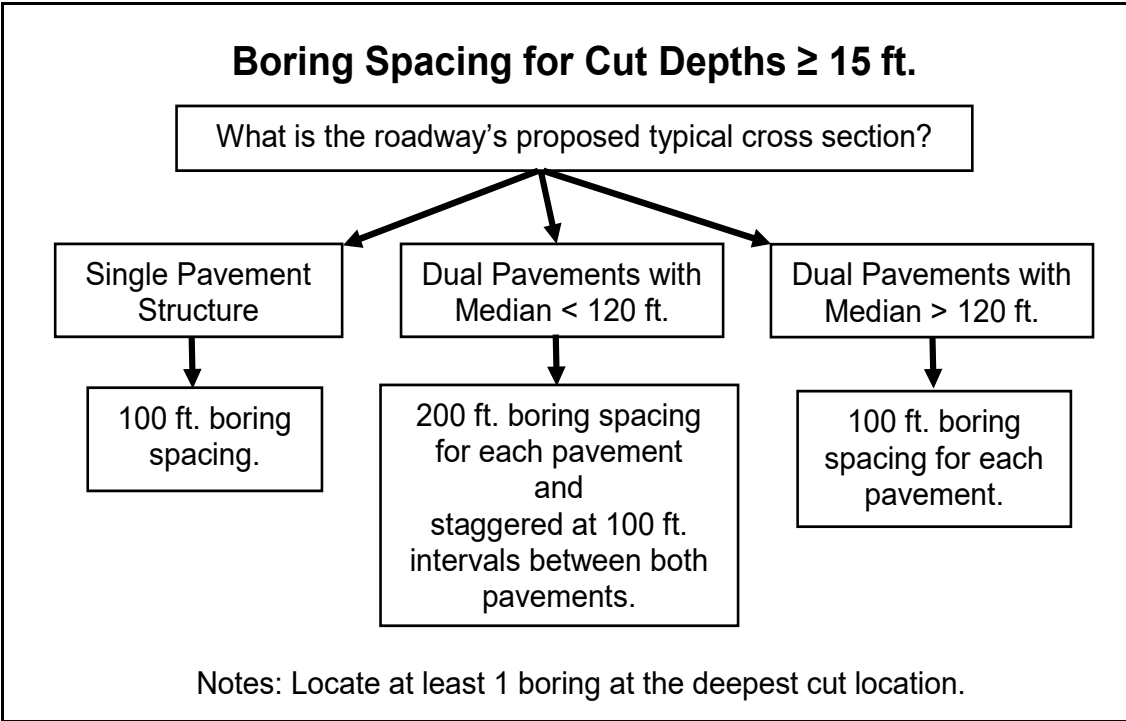

Figure 3.4.2-2(a) Boring Spacing for Cut Depths Greater than or equal to 15 ft.

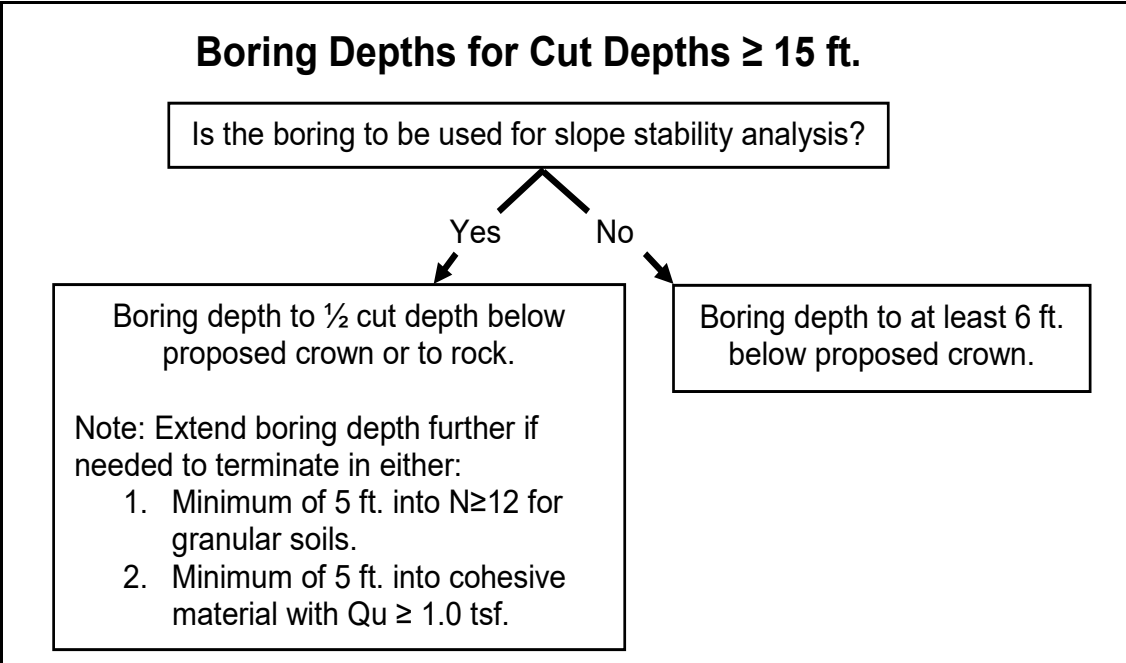

Figure 3.4.2-2(b) Minimum Boring Depths for Cut Depths Greater than or equal to 15 ft.

Geotechnical Manual

Chapter 3 Reconnaissance and Project Scoping

3.4.2.1 Spacing Requirements

When the roadway embankment will be greater than or equal to 15 ft. in height, the maximum boring interval should be 200 ft. along the centerline of single pavements or along the median if the embankment will support dual pavements. If the soil profile is quite variable or if the borings do not reveal a consistent pattern of weak or compressible materials, then additional borings should be made to delineate the depth and extent of such unstable materials. A minimum of one boring should be made at the greatest height of the embankment. Refer to [Figure 3.4.2-1\(a\)](#) for a summary of these boring spacing requirements.

If the crown grade of the proposed roadway is to be excavated to a depth greater than or equal to 15 ft., the line boring interval should be 100 ft. or less. Multiple pavements may be treated as previously described in [Section 3.4.1.1](#), with at least one boring made at the deepest cut. Refer to [Figure 3.4.2-2\(a\)](#) for a summary of these boring spacing requirements.

3.4.2.2 Depth Requirements

In fill areas, stability borings should extend to a minimum depth of $2/3$ the height of the proposed embankment. If bedrock is encountered at a lesser depth, the borings may be terminated. The presence of bedrock should be verified by either a geologic map during the review stage, or drilling an extra 3 ft. If the initial borings or geologic conditions warrant deeper borings, they should terminate at a minimum of 5 ft., into cohesive materials having a minimum Rimac or Shelby tube Q_u of 1 tsf, or into granular materials having a minimum N value of 12. The number and spacing of the stability borings for embankments less than 15 ft. in height shall be determined as discussed in the previous paragraph for shallow cut sections. Refer to [Figure 3.4.2-1\(b\)](#) for a summary of these minimum boring depth requirements.

In cut areas, stability borings should penetrate to a minimum depth below crown grade of one-half the depth cut, or to bedrock, whichever is encountered first. In all cases, the boring should terminate at a minimum of 5 ft., into cohesive material having a minimum Rimac or Shelby Tube Q_u of 1 tsf, or into granular materials having an N value of 12. If the cut is to be less than 15 ft. in depth, the borings should extend to a depth of 6 ft. below the proposed crown grade. In this case, the number and spacing of the stability borings should be based on the complexity of the

Geotechnical Manual

Chapter 3 Reconnaissance and Project Scoping

soil and rock profile. Refer to [Figure 3.4.2-2\(b\)](#) for a summary of these minimum boring depth requirements.

3.4.2.3 Sampling Requirements

For slope stability analysis in fill or cut areas, Shelby tube samples and/or SPT borings with split-spoon samples should be taken, depending on the soil type. Generally, in sandy soils, split-spoon samples are preferred. In cohesive silty and clayey soils, the Shelby tube samples are more reliable. Other intact (relatively undisturbed) sampling systems may also be used at the discretion of the DGE. If these systems are used, the wall thickness of the tubes should result in an area ratio (A_r) which does not exceed 30% as defined by [Eq. 4.4.4.7-1](#) in [Section 4.4.4.7](#).

3.4.3 Structure Borings

A split-spoon boring (or SPT) for structure foundations is traditionally referred to as a “structure” boring, by IDOT. For the past several decades, it has been the practice to advance (structure) borings at appropriate locations, determine the SPT N value, and extract split-spoon soil samples. Cohesive soil samples are tested in the field for Q_u , using an IDOT approved, gear-modified Rimac spring tester as described in [Section 4.4.5.2.1](#). The samples are visually described (i.e. color, texture, relative density or consistency) and recorded in the boring log. Representative samples are then returned to the lab for moisture content determination.

The boring is advanced to a depth which will provide sufficient information to address bearing, slope stability, and settlement. Nominal boring depths for different types of structures are included in the following sections. However, field judgment will be necessary to develop the boring program, and to present satisfactory data for the probable choice(s) of foundation treatment. Details of these treatments are included in [Chapter 6](#).

Geotechnical Manual

Chapter 3 Reconnaissance and Project Scoping

3.4.3.1 General Boring Requirements

The following series of guidelines were compiled to secure foundation borings as close as possible to the proposed substructure, culvert, or wall locations obtained from the structural engineer. The subsurface exploration program should be developed as follows.

It is recognized, that the following designated boring locations are idealized and may not be achieved for some projects, due to terrain and/or stream conditions. In such cases, the geotechnical engineer should exercise judgment and place the borings in the most appropriate locations possible.

When the structure borings indicate the presence of low strength and/or compressible soils, and a new or higher embankment is called for, intact (relatively undisturbed) Shelby tube sample borings should be made, as required in [Section 3.4.4.3](#).

The usual vertical spacing of the SPT split-spoon samples is 30 in. from the beginning of one sample interval to the beginning of the next, from the ground surface to 30 ft. The interval thereafter may be increased to 5 ft. between samples. However, a 30 in. sampling interval throughout the entire depth of the boring is preferable, and it may be necessary in cases of highly variable soil deposits and cut sections in order to obtain sufficient data for analysis.

If hard drilling ($N > 60$) in glacial till, or very dense granular soil, is first encountered at the required termination depth of a structural boring; that boring should be extended a minimum of four sampling increments, or 10 ft. through the deposit.

3.4.3.2 Borings for Bridges

- a) Take one SPT boring as close as possible to each proposed abutment location, and one SPT boring as close as possible to each proposed pier location, if known. For example, dual structures would require four abutment borings, plus multiple pier borings.

- b) The boring locations should be in a staggered pattern at adjacent substructure units if possible.

Geotechnical Manual

Chapter 3 Reconnaissance and Project Scoping

- c) Unless rock is encountered first, all structure borings should be drilled to a depth that will achieve a minimum Nominal Driven Bearing capacity of 500 kips for a 14 in. diameter metal shell pile. However, the boring depths may be tailored if the estimated maximum loads per pile are known, or the structural engineer is confident in the use of a particular pile type. In such case, the boring depth should achieve a minimum capacity of 110% of the estimated maximum pile loads. Nominal pile capacity determination during the drilling operation is derived from the side resistance and end bearing given in [Tables C.3-1 through C.3-9](#) in [Appendix C.3](#).

When the boring penetrates a compressible soil unit, the pile capacity above this unit should be discounted for determining the required boring depth. As a guideline, a compressible soil unit is a cohesive soil with a R_{mac} Q_u of 0.20 tsf, moisture content of 25% or higher, and the proposed new fill height is at least 15 ft.

- d) In high seismic areas, particle size analysis should also be performed on representative samples of soils suspected to be liquefiable.
- e) When the proposed bridge width is greater than 75 ft., 2 borings (towards each end) should be made for each substructure unit.
- f) When an existing bridge is to be widened on both sides, it should be considered as a dual structure when the width of the existing bridge is greater than 75 ft. When the existing bridge is less than 75 ft., the type of existing foundation will govern: drill borings for spread footings, as a dual structure; and for piles or drilled shafts, as a single structure.
- g) Rock drilling should be conducted when spread footings, piles or drilled shafts are to be set into bedrock. Rock cores should be obtained when bedrock is less than 15 ft. below stream bed, or the ground surface is less than 15 ft. above bedrock. The cores shall extend a minimum of 15 ft. into bedrock.
- h) For drilled shaft foundations, it is important to have the 24 hour delayed groundwater level reading for use in design and construction. In some cases, it can be very challenging or impractical to obtain a 24 hour delayed groundwater reading. This may be due to several

Geotechnical Manual

Chapter 3 Reconnaissance and Project Scoping

factors including use of drilling fluid, artesian groundwater conditions, or collapse of the borehole. Site access constraints and proposed foundation locations may also be such that borings are located where it is a safety concern to leave the borehole open and/or the maintenance of traffic for overnight lane closures is cost prohibitive to obtain the 24 hour delayed reading. For such occurrences, a piezometer(s) or groundwater monitoring well(s) should be installed to establish the long term groundwater elevation for a project area as an alternative means to determining the delayed groundwater level.

- i) For construction within the City of Chicago, vane shear testing may be required. The [City of Chicago \(2015\)](#) has an Existing Facility Protection (EFP) Review process. This includes construction permit processing through the Office of Underground Coordination (OUC) within the Chicago Department of Transportation (CDOT), Division of Infrastructure Management. Both private and public developments which have excavations, foundations or earth retention system penetrations equal to or greater than twelve (12) feet below adjacent Public Way grade are subject to OUC review and permitting for construction. Requirements by the OUC include vane shear testing of soft clays ($Q_u \leq 0.5$ tsf) for earth retention systems and drilled shafts for a minimum of 2 borings be included in the Geotechnical Report. (The requirements listed above will need to be verified with the City of Chicago before beginning subsurface exploration and adjusted as appropriate.) See [Section 4.4.5.1.2](#) for information on vane shear testing.

3.4.3.3 Borings for Culverts

Borings should be obtained for culverts with cross sectional openings greater than 12 square feet. Estimate the culvert length and plan a boring program according to the following schedule:

- a) Take one boring at each end of the culvert, in a staggered pattern. If the culvert is skewed, the two borings should be obtained adjacent to the two longest wingwalls.
- b) If horizontal cantilever wingwalls are anticipated and stage construction is required, no wingwall borings would be needed. However, at least one boring should be made, as close as possible, to the roadway/culvert centerline. The soils information from such a

Geotechnical Manual

Chapter 3 Reconnaissance and Project Scoping

boring will be necessary for the design of stage construction sheet piling, or other shoring methods.

- c) If culvert length is from 75 ft. to 150 ft., take an additional boring at mid length.
- d) Take an additional boring for each culvert length increase of 75 ft. increments. The borings should be spaced, as evenly as possible, along the length of the culvert.
- e) All culvert structure borings should be drilled to a depth of at least 2.0 times the fill height (the distance between the proposed crown grade and the flow line), unless bedrock is encountered first.
- f) Rock cores should be obtained when the bedrock appears to be at the bearing elevation of the culvert or wing wall footings. The cores shall extend a minimum of 10 ft. into bedrock.

3.4.3.4 Borings for Retaining Walls & Other Earth Retention Systems

The wall type, location, and limits are often not complete at the stages of a project when borings are required. Therefore, discussions with the structural engineer are critical to determine the preliminary type, size and location. In addition, the Project Report and any other preliminary analyses or information which gives indications of likely wall heights and locations (stations, offsets, and lengths) should be used. The following general guidelines should be used, to develop an adequate subsurface exploration program:

- a) Take a minimum of 2 borings per wall.
- b) For walls less than or equal to 20 ft. in height, use a maximum boring spacing of 75 ft.
- c) For wall heights greater than 20 ft., use a maximum boring spacing of 50 ft.
- d) If possible, one boring should be located near the expected highest portion of the wall.

Geotechnical Manual

Chapter 3 Reconnaissance and Project Scoping

- e) The above borings should be located along the proposed wall face. Additional borings should be taken every 200 ft. behind the wall, at a distance equal to the wall or so to define the soil profile in the transverse direction to the wall if possible.
- f) Borings should be continued to sufficient depths, well below the anticipated wall bottom, to determine the complete subsurface profile behind and below the anticipated wall and allow the estimation of pile lengths, if necessary. At a minimum, the boring should be completed to a depth of 2 times the exposed wall height unless bedrock is encountered first.
- g) Rock coring should be conducted when the bedrock appears to be at the bearing elevation of the wall. A minimum of one boring should be cored per wall with additional rock coring at 150 foot boring spacing intervals for longer walls. The rock cores shall extend to a minimum depth of 10 ft. into bedrock.
- h) For earth retention structures with top-down excavation below the existing grade, it is important to have the 24 hour delayed groundwater level reading for use in design and construction. In some cases, it can be very challenging or impractical to obtain a 24 hour delayed groundwater reading as discussed in [Section 3.4.3.2](#) Item h). For such occurrences, a piezometer(s) or groundwater monitoring well(s) should be installed to establish the long term groundwater elevation for a project area as an alternative means to determining the delayed groundwater level.
- i) For construction permitting within the [City of Chicago \(2015\)](#), vane shear testing of soft clays ($Q_u \leq 0.5$ tsf) may be required for earth retention structures with excavation equal to or greater than twelve (12) feet below the existing grade (for a minimum of 2 borings) to be included in Geotechnical Report. (The requirements listed above will need to be verified with the City of Chicago before beginning subsurface exploration and adjusted as appropriate.) Refer to [Section 3.4.3.2](#) Item i) for further information on the City of Chicago's requirements, and see [Section 4.4.5.1.2](#) for information on vane shear testing.

Geotechnical Manual

Chapter 3 Reconnaissance and Project Scoping

For retaining walls with a maximum exposed height of 7 feet or less, the need for borings vary depending on the type, size, location, and function of the wall. In such cases, the need for borings on these minor wall structures shall be determined by the DGE.

3.4.4 Special Investigation Explorations

There are several types of subsurface explorations which lie outside of those typical of Roadway and Structure Geotechnical Reports. These fall under the Special Investigations Explorations category as they are routinely performed as separate projects. However, some of these explorations may be incorporated into a Roadway or Structure Geotechnical Report as appropriate for a specific project.

3.4.4.1 Traffic Structure Borings

A boring program is required for sign trusses and high mast lighting, and it is recommended for traffic signals mast arms. A boring program may also be recommended for other uncommon, non-standard traffic structures which require shaft foundations, and the FGU should be contacted for guidance in such cases. These structures have high overturning loadings mainly due to wind, and some of these structures may have only a single shaft foundation with no redundancy. Thus, knowing the soil parameters at the shaft station and offset are extremely important to assure a safe design.

Unless specified otherwise in the following sub-sections, an SPT split-spoon (structure) boring should be drilled, at the foundation location, to a depth of at least one sample interval beyond the assumed shaft depth "D". The results of the SPT (N value), and the Rimac Q_u tests should be recorded on the boring logs. Samples should be taken to the lab for moisture content determination. The Q_u values should not be obtained from the pp test on auger cuttings. This may be done only if the boring location cannot be accessed by a drill rig, in which case a hand auger must be used instead. In soft clays, the Q_u obtained from the pp test on auger cuttings significantly underestimates the actual *in situ* soil strength. This would unnecessarily require a deeper boring and a larger foundation size. If bedrock is encountered prior to reaching the bottom depth of the proposed shaft foundation, rock cores shall be obtained. The rock cores shall extend

Geotechnical Manual

Chapter 3 Reconnaissance and Project Scoping

to a depth of at least 75% of the remaining foundation shaft length or a minimum of 5 ft., whichever is greater.

3.4.4.1.1 Sign Structure Borings

For sign structures, contact the designer to determine the proposed type and size of sign structure. This information is used to determine the standard foundation depths. For [Cantilever](#), [Butterfly](#), [Tri-Cord](#), and [Single and Double Monotube](#) sign structures, the foundation shaft depths are shown on the base sheets. These base sheets are available on the IDOT web site and are contained in the [Sign Structures Manual](#). [Simple Span Overhead](#) sign structure foundation shaft depths are provided in Section 2.1 of the [Sign Structures Manual](#), and these depths are based on span length and sign area. Borings for sign structure foundations should be drilled to a depth of at least one sample interval beyond the structure's standard foundation depth. If the average Q_u is less than 1.25 tsf, extend the boring to a depth equal to 1.25 times the standard shaft depth divided by the average Q_u obtained while drilling the base sheet or design table shaft depth.

3.4.4.1.2 Traffic Signal Mast Arm Structure Borings

For traffic signal mast arm foundations, drill the boring to a depth of at least one sample interval beyond the standard shaft foundation depth shown in the design table of [Highway Standard 878001](#). When the average Q_u is less than 1.0 tsf, extend the boring to a depth equal to the standard shaft depth divided by the average Q_u obtained while drilling the standard shaft depth.

3.4.4.1.3 High Mast Lighting Structure Borings

For high mast lighting towers, use the design table in [Highway Standard 837001](#) to obtain the minimum required boring depth. From the design table, the shaft length varies depending on the height of the tower and the average strength of the soil. The boring depth should be drilled to at least one sample interval beyond the standard shaft foundation depth shown in the highway standard design table. The average soil strength should be computed during the drilling and compared with the design table to determine the required boring termination depth.

Geotechnical Manual

Chapter 3 Reconnaissance and Project Scoping

3.4.4.2 Noise Abatement Wall Borings

Noise abatement walls (noise walls) are typically founded on drilled shafts. SPT borings for noise walls should be drilled to a minimum depth of 15 ft. below the bottom of the proposed noise wall panel. If rock is encountered within this depth, the borings should be extended 10 ft. into the rock.

Borings should be located along the wall alignment at evenly spaced 200 ft. intervals. If the subsurface conditions are found to be non-uniform or the existing terrain along the proposed wall alignment is highly variable, the boring spacing may be decreased to 100 ft. at the direction of the DGE. If practical, one of the borings should be located as close as possible to the location of the maximum exposed wall panel height.

3.4.4.3 Shelby Tube Borings

Shelby tube borings are drilled in order to obtain intact (relatively undisturbed) soil samples for more detailed testing. Generally, Shelby tubes are taken in weak cohesive soils ([Section 4.4.4.6](#)). They are necessary when embankment slope stability and/or settlement are judged to be marginal, or below design standards. The accepted IDOT practice is intact (relatively undisturbed) Shelby tube sampling and laboratory testing would be necessary if the stability analysis, based on split-spoon samples, yields a safety factor less than 1.5 for embankments, or 1.7 for cut slopes. For slope stability and settlement analyses: unconfined (laboratory) compression tests, triaxial compression tests, unit weight tests, moisture content tests, and visual soil descriptions (i.e. color and texture) are performed. Atterberg limits, plasticity index (PI) and particle size analysis tests may be performed. For settlement analysis, consolidation tests are also performed.

If low strength, compressible soils are encountered, and the boring is at or adjacent to a new or higher proposed fill, the DGE should be contacted to determine if intact (relatively undisturbed) samples should be obtained for additional testing. If time does not permit a more rigorous analysis, critical soil strengths can be approximated by the equation:

$$Q_u \text{ critical (tsf)} = \text{Fill Height (ft)} \div 35 \quad (\text{Eq. 3.4.4.3-1})$$

Geotechnical Manual

Chapter 3 Reconnaissance and Project Scoping

When the Q_u for the structure boring is less than the Q_u critical, Shelby tube borings should be made and analyzed for stability.

Also, as a rule of thumb, Shelby tubes are required to accurately quantify settlements, when the fill height is greater than 15 ft. and the moisture content is in excess of 25%.

3.4.4.4 Pavement Coring

Evaluation of existing pavement conditions is not a geotechnical function. It is the responsibility of the district's bureau of Program Development in coordination with the district Materials Section. However, the district Geotechnical Unit is routinely tasked with obtaining pavement cores since this unit is staffed and equipped to successfully accomplish this function. Scoping of the number and locations of cores is typically performed by the designers and/or the District Mixtures Control Engineer.

Where drainage and/or subgrade support concerns are suspected to attribute to pavement deterioration, additional testing and sampling of the underlying base/subbase and subgrade materials at the core location is warranted. Testing and sampling commonly include DCP tests through the core hole and sampling for soil index property tests. This is a geotechnical function and requires coordination with the DGE.

Refer to Chapter 53 of the [BDE Manual](#) for additional guidance and information regarding pavement coring.

Geotechnical Manual

Chapter 3 Reconnaissance and Project Scoping

3.4.4.5 Pavement Rubblization Geotechnical Studies

Rubblization is the process of breaking up existing Portland Cement Concrete (PCC) pavements into pieces. Generally, 75% of the upper half of the existing pavement is required to be broken up into pieces not greater than 3 inches, and 75% of the lower half of the pavement is required to be broken up into pieces not greater than 9 inches. The pavement, in effect, becomes a high quality, free draining aggregate base. Rubblization differs from new construction in that the subgrade cannot be modified or improved. Generally, if the existing PCC pavement is less than 6 inches thick and/or is supported on weak subgrade soils, rubblization is probably not a viable option. This is because the rubblization process would likely cause a significant percentage of the rubblized pieces of the existing PCC pavement to sink into the subgrade such that it is no longer satisfactory for its intended use as a base. Due to the cost of remediation for cases like this, reconstruction is likely the more economical option compared to a rubblization (combined with overlay) procedure. Therefore, a thorough geotechnical study is necessary in order to obtain the necessary information to determine the feasibility of rubblization. The necessary information is as follows:

- The existing pavement cross section and the condition of each pavement layer, including overlays and subbase.
- The rubblized pavement and subgrade stability, for supporting construction activities.
- The shoulder pavement and subgrade stability, to support traffic for construction staging.
- The subgrade IBV, IBR and SSR, based on field and lab tests or available data.
- The locations where undercuts or alternative rehabilitation should be used.
- The condition of existing underdrains and the need for replacement.
- The groundwater elevation.

The DGE will determine the type and extent of geotechnical study needed, for a rubblization project. Section 54-5.03(b) of the [BDE Manual](#) should be referred to for guidance in the scoping process, and a copy of the special provision for rubblizing PCC pavement also can be obtained from the Pavement Technology Section in the Bureau of Research (unless it becomes available in the next update to the IDOT *Standard Specifications for Road and Bridge Construction*). As a minimum, a study consists of the following two phases:

Geotechnical Manual

Chapter 3 Reconnaissance and Project Scoping

- a) Preliminary Soils Review – In this phase, the DGE should review available Geotechnical Reports, plans and cross sections of the existing pavement, and the USDA/NRCS County Soil Survey Reports ([Section 3.2.2.3.2](#)). Based on the available data, the [SSM](#), and the SSR; the pavement and subgrade conditions should be analyzed. This step is a screening process intended to eliminate sections which will most likely fail the Subsurface Exploration phase, due to weak subgrade. The DGE must provide the designer with the preliminary information and discuss the feasibility of the rubblization option.

- b) Subsurface Exploration – The DGE must prepare a pavement coring, DCP, and soil sampling and testing plan for the section, to confirm the preliminary soils review. In general, a minimum of 3 pavement cores per lane-mile should be taken. However, if core locations are staggered between lanes, then a minimum of 2 pavement cores per lane-mile may be taken. The core spacing may be decreased, depending on cuts, fills, soil types and available data. After the pavement core is removed, the DCP test is conducted in the hole to determine the subgrade IBV. It is preferable to record single blow increments to a depth of 30 in. If a granular base exists, the DCP may be driven through it and the depth estimated from the IBV. A bulk soil sample in the range of 6 to 8 lbs. should be taken from the core location and stored in an airtight container for later testing, if required. A minimum of 1 DCP test per 1,000 ft. must be conducted along the shoulder, as close to the pavement to be rubblized as possible, to support public traffic during a staged construction. This testing frequency may be reduced when the shoulder will not support traffic. Care should be taken to avoid any damage to existing underdrains or other underground utilities.

The need for laboratory testing of field samples depends on the results of the field survey. After the field survey is complete, typical IBVs and the condition of each pavement layer are determined. The [SSM](#) should be used to determine whether or not the existing rubblized pavement (including the subbase and other pavement layers) provides enough cover over the subgrade. Section 54-5.03(b) of the [BDE Manual](#) should be used to determine the viable method(s) of rubblization. If the total thickness of these layers exceeds the minimum needed, then rubblization is viable. If results are marginal, the field soil samples must be tested for the *in situ* moisture, AASHTO M 145 classification and

Geotechnical Manual

Chapter 3 Reconnaissance and Project Scoping

group index, particle size, and organic content. From this data, the DGE will determine whether or not the subgrade may become further weakened from higher moisture or heavy loads.

For reporting requirements, see [Section 7.5.1](#) of this Manual and Section 54-5.03(b) of the [BDE Manual](#).

3.4.4.6 Slope Failures

The DGE will determine the type and extent of geotechnical study and exploration for remediating slope failures. Each project is tailored depending on factors including the size of the failure, location, and risk to the operational function and safety of the roadway corridor. If required, the DGE should contact the Central Office Geotechnical Engineer at the CBM for assistance.

3.4.4.7 (Reserved)

3.4.4.8 Bedrock Sounding and Coring

In areas where the geologic information or logs (obtained from the preliminary soil exploration) indicate the presence of rock near or above final grade, sufficient soundings or probes must be made to delineate the profile and cross section of the bedrock surface. Rock sounding may be made by any means capable of delineating the top of the rock unit. Such methods may include hand or power auguring, pushing a pipe, using a tile probe, or using a truck mounted percussion rig. Also, it may require geophysical investigative means in some circumstances.

Preliminary soundings can be made at intervals of approximately 200 ft. along the centerline (preferably, at alternate stations) to determine whether rock will be encountered at an elevation above the proposed ditch grade. In areas of varying topography, it may be advantageous to deviate from the regular plan by taking soundings at the highest and lowest contour points.

If it is determined that rock will be encountered during construction of the project, additional soundings must be taken to estimate rock excavation. These soundings are usually taken at 50 ft. intervals along the centerline and at both ditch lines. If there is more than one pavement,

Geotechnical Manual

Chapter 3 Reconnaissance and Project Scoping

rock soundings should be taken in this manner along both lanes, unless the rock surface is relatively even, and reasonable predictions can be made by considering the multiple lanes as one unit. In cases where the rock surface is very uneven, or where the rock surface slopes transversely to the centerline, additional soundings may be required for accurate profiling of the surface.

Sufficient rock core borings should be made into the rock, in conjunction with the soundings, to determine the type and condition of the rock. These borings should extend a minimum of 12 in. below the proposed ditch line, and preferably 24 in. below the proposed grade line (PGL).

Accurate estimates of the rock volume are required to establish reasonable pay quantities for rock excavation. Good documentation of the rock characteristics, in the contract, will help reduce the incidence of changed conditions during construction.

In some cases, geophysical surveys (especially the seismic method), can be very useful in mapping the bedrock surface. These surveys should be conducted in conjunction with a nominal number of borings, to check the accuracy of the seismic survey. Geophysical surveys require specialized knowledge to properly interpret the data.

3.4.4.9 Peat Soundings

Peat, and other soft, or highly organic deposits present special problems for highway construction. Thus, whenever deposits of peat or other highly organic materials are encountered within the proposed R.O.W., soundings must be made at sufficient intervals to accurately determine the extent of peat, or other soft material present. If the peat is not more than 3 to 5 ft. deep, this can ordinarily be done with a hand or power auger. For deeper peat deposits, however, the Michigan (Davis) peat sampler is the most useful tool.

In most cases, soundings of the bottom of the deposit should be made at 50 ft. intervals, both longitudinally and transversely in the R.O.W. Additional intermediate soundings may be necessary to accurately profile the bottom, where appreciable changes in depth are found between soundings. For embankments, the soundings should extend a minimum of 50 ft. beyond the toe.

Geotechnical Manual

Chapter 3 Reconnaissance and Project Scoping

Some highly organic deposits are underlain by extremely soft, fine grained materials (often partly mineral, partly organic) called Marl. These materials usually have excessively high moisture contents, and can cause slope stability problems, and/or settlement of the embankments placed on them. Shelby tube samples of the soft sediments should be obtained for consolidation and shear strength testing. The data is used to make reasonable estimates of the depth of excavation necessary to provide a stable embankment.

In some cases, the surface of an organic deposit may be covered by materials which have been transported in by flowing water, subsequent to the peat formation. The organic material, which is covered by these deposits, may be somewhat more compressed than in open swamps. However, the organic material is quite compressible when subjected to the weight of embankments of reasonable height. It is extremely important that such soil areas be located and thoroughly explored, during the soil survey.

3.4.4.10 Groundwater Elevation Observation

Groundwater levels are routinely observed and recorded while conducting subsurface explorations through soil borings, test pits, and road or stream cuts. These observations are normally performed over a very short time period of about 24 hours. Occasionally conditions warrant groundwater observations over a longer duration. Observation of changes in excess pore water pressure during embankment construction and settlement is one of the most common applications. However, groundwater elevation observation may also be a component in the long term monitoring and evaluation of areas with document slope movements. For long term observation of groundwater levels, groundwater observation wells (piezometers) should be installed and are discussed further in [Section 4.6.1](#).

3.4.4.11 Detention Ponds and Wetlands

Studies required for detention ponds and wetlands are, generally, site-specific. Therefore, it is difficult to generalize requirements for the explorations of such sites. For very preliminary studies, the best sources are USDA/NRCS soil survey publications.

Geotechnical Manual

Chapter 3 Reconnaissance and Project Scoping

3.4.4.12 Borrow Pits

Borrow pit investigations are primarily directed toward determining the suitability of the soil at a site for use in embankment construction. Contractors are typically required to identify and propose potential borrow pits during construction. However, IDOT supplied borrow sites may also occasionally exist. Once a borrow pit has been proposed by a contractor or an IDOT supplied site is designated, personnel representing the Department perform subsurface exploration, sampling and testing to determine suitability of the soil(s).

Exploration and sampling of borrow pits are typically performed by open cutting and bulk sampling methods. However, borings may be necessary for deep pits or IDOT supplied borrow sites. The number of investigation points (borings and/or bulk sample locations), spacing, and sampling frequency should be sufficient to determine the soil types and layer thicknesses within a proposed site. The appropriate number of investigation points will be dependent on a site's stratigraphy. Since excavation will frequently intermix soil units, thin soil seams within thicker units generally do not need to be tested separately. However, deleterious properties, of even thin soil seams, should be noted and their placement monitored during construction. In general, representative soil samples should be obtained from a proposed borrow pit to facilitate testing and determination of Atterberg limits (liquid limit and plasticity index), particle size analyses, AASHTO M 145 group classifications, Illinois textural classifications, organic content, and moisture-density relationships. In some cases, tests for remolded compressive strength, Immediate Bearing Values (IVBs), or Illinois Bearing Ratios (IBRs) may also be appropriate.

Stability of a site can also be a concern and should be evaluated when warranted. The requirements in Section 204 of the IDOT [Standard Specifications](#) addressing aesthetic concerns of slopes for Borrow and Furnished Excavation are typically sufficient to alleviate potential stability problems.

3.4.5 Field and Laboratory Testing of Samples

The material properties and characteristics of soil and rock samples are determined through a variety of standard field and laboratory tests. [Chapter 4](#) and [Chapter 5](#) of this Manual provide more details on the field and laboratory test methods, respectively. This section presents the

Geotechnical Manual

Chapter 3 Reconnaissance and Project Scoping

Department's standard practice regarding the type and frequency of testing for soil and rock samples obtained during field explorations. The determination of any additional testing is done on a project specific basis in order to obtain sufficient information to facilitate a cost effective, safe, durable, and functional design.

SPT Borings:

- **Rimac:** Perform field Rimac Q_u tests on every split-spoon sample recovered unless the sample cannot hold shape (cohesionless, low strength, or fractured) or is insufficient in length for testing. When possible, perform Rimac Q_u tests on each soil type recovered if there is a change in material within the split-spoon sample.
- **Pocket penetrometer:** If the sample recovered in the split-spoon is cohesive but not sufficiently intact for Rimac testing, then pocket penetrometer testing is permissible.
- **Moisture content:** Perform laboratory moisture content determination on each split-spoon sample and on each soil type if there is a change in material within the split-spoon.

Shelby Tubes:

- **Tube sampling frequency (all applications):** Shelby tubes borings are taken for use in analyses of settlement and slope stability. The tubes shall be taken continuously through the entire depth of the boring. The exception to continuous tube sampling is that it may gap layers of cohesionless soils if the Shelby tube boring is taken within 15 ft. of a corresponding SPT boring.
- **Slope stability applications:** When Shelby tubes borings are taken for applications of only slope stability analyses, the minimum laboratory testing requirements for each tube are as follows:
 - Sub-divide the recovered material in the tube into 6 to 8 inch intervals. Descriptions of each of the sub-divided segments using visual-manual identification.
 - Provided that the sample is sufficiently intact among the sub-divided segments, perform a minimum of one (1) unconsolidated-undrained (UU) triaxial test or one (1) consolidated-undrained (CU) triaxial test with corresponding density (unit weight) and moisture content determinations.
 - On each of the remaining segments, perform unconfined compressive strength tests with density (unit weight) and moisture content determinations.

- **Settlement applications:** For applications where only settlement analysis is planned, the minimum laboratory testing requirements for each tube are as follows:
 - Sub-divide the recovered material in the tube into 6 to 8 inch intervals. Descriptions of each of the sub-divided segments using visual-manual identification.
 - Provided that the sample is sufficiently intact among the sub-divided segments, perform a minimum of one (1) one-dimensional consolidation test with corresponding density (unit weight) and moisture content determinations.
 - On each of the remaining segments, perform unconfined compressive strength tests with density (unit weight) and moisture content determinations.

- **Settlement and slope stability applications:** Where both settlement and slope stability analyses are planned, the minimum laboratory testing requirements for each tube are as follows, provided that the sample(s) is sufficiently intact:
 - Sub-divide the recovered material in the tube into 6 to 8 inch intervals. (Using 7.5 inch lengths work well on 3" diameter tubes to obtain 4 sub-divided segments.) Descriptions of each of the sub-divided segments using visual-manual identification.
 - Choose an appropriate specimen(s) for consolidation testing. Perform a minimum of one (1) one-dimensional consolidation test with corresponding density (unit weight) and moisture content determinations.
 - A triaxial sample will then be chosen from a sample of similar material directly adjacent to the previously chosen consolidation sample. Perform a minimum of one (1) unconsolidated-undrained (UU) triaxial test or one (1) consolidated-undrained (CU) triaxial test with corresponding density (unit weight) and moisture content determinations.
 - Additional samples for triaxial testing shall also be chosen if there is a change in material within the length of the tube, and particularly for material types that are not normally tested for consolidation properties, e.g. sandy and/or highly-silty materials.
 - On each of the remaining segments, perform unconfined compressive strength tests with corresponding density (unit weight) and moisture content determinations.

Geotechnical Manual

Chapter 3 Reconnaissance and Project Scoping

Rock Cores:

- After the RQD has been determined, perform laboratory uniaxial compressive strength tests with corresponding density (unit weight) and moisture content determinations on as many segments of the core as possible where samples can be cut to sufficient length and be intact for testing.

Subgrade Borings:

- Borings taken for roadway subsurface profiles may be obtained by several methods at continuous sample intervals. For samples obtained with either push-spoons or SPT split-spoons, the follow field tests are required:
 - **Rimac:** Perform field Rimac Q_u tests on every spoon sample recovered unless the sample cannot hold shape (cohesionless, low strength, or fractured) or is insufficient in length for testing. When possible, perform Rimac Q_u tests on each soil type recovered if there is a change in material within the spoon sample.
 - **Pocket penetrometer:** If the sample recovered in the spoon is cohesive but not sufficiently intact for Rimac testing, then pocket penetrometer testing is permissible.
- For samples obtained with other methods such as hand augers where samples are not sufficiently intact for Rimac Q_u 's, then **pocket penetrometer** testing is permissible.
- Laboratory testing: In every fifth boring along the alignment and for every material change throughout the depth of that boring shall have the following laboratory index property tests for classification. If there is a change in soil type in the borings located between the borings receiving full depth testing, then these soil types shall also have the following laboratory tests:
 - **Moisture content:** Perform laboratory moisture content determination on each split-spoon sample and on each soil type if there is a change in material within the split-spoon.
 - **Atterberg Limits**
 - **Grain size distribution with hydrometer**
 - **IDH and AASHTO M 145 Classifications**
 - Other tests as required by the DGE

Geotechnical Manual

Chapter 3 Reconnaissance and Project Scoping

Bulk Samples:

- Bulk samples obtained in proposed cut and at-grade (subgrade) sections for material anticipated to be used as fill or part of the upper 2 feet of proposed subgrade shall be tested for:
 - Standard Proctor (Moisture-Density Relationship test)
 - Atterberg limits
 - Grain size distribution with hydrometer
 - Other tests as required by the DGE

Geotechnical Manual
Chapter 3 Reconnaissance and Project Scoping

This page left intentionally blank.

Chapter 4 Subsurface Explorations & Field Testing

4.1 Introduction

Subsurface explorations and subsequent laboratory testing are both key to providing quality recommendations for a project. An exploration should sufficiently characterize the geological profile and subsurface material properties at a site. As such, due diligence is required when formulating and executing a Subsurface Exploration Plan (SEP). The number, locations, and potential depths of drilled borings as well as other site sampling and testing methods should be carefully planned. Care should also be taken during the exploration such that representative samples of good quality are obtained and completely documented. Field test results should accurately measure and reflect conditions encountered at a site as well as be interpreted with the requisite level of expertise. The results of laboratory tests conducted on samples taken in the field provides the last set of information required for the geotechnical engineer to perform final analyses and make sound recommendations for design. Insufficient, poorly planned, and/or poorly executed subsurface explorations may result in unanticipated discovery of weak, wet, or frost susceptible soils; or inaccurate predictions of soil behavior during construction that can potentially lead to expensive delays and redesigns.

This chapter discusses Department policies, general processes and procedures for successfully planning and conducting subsurface explorations to adequately assess the subsurface conditions on highway projects. Subsurface monitoring practice guidance and routine construction material field test methods are also discussed in the latter sections of this chapter.

4.2 Field Test Equipment Calibration, Verification, Standardization and Check Requirements

Subsurface exploration and field testing equipment is required to be calibrated at minimum specified intervals as a means to ensure equipment is accurate and dependable. However, heavy use or specific test requirements may dictate the necessity for more frequent calibration, verification, standardization or checks. Equipment calibration, verification, standardization and/or

Geotechnical Manual

Chapter 4 Subsurface Explorations and Field Testing

check records shall be maintained by the owner of the equipment and made available during laboratory inspections. Consultants shall submit copies of calibration, verification, standardization and/or check records as required by the Department. For specific projects, consultants shall also submit calibration, verification, standardization and/or check records for SPT hammers and Rimac spring testers to the DGE as an attachment to subsurface exploration plans.

[CBM Policy Memorandum 21-08.3](#), “Minimum Department and Local Agency Laboratory Requirements for Construction Materials Testing or Mix Design” (Table 2) provides information on calibration, verification, standardization and check intervals for various types of soils testing equipment. If calibration, verification, standardization and/or check intervals for equipment are not covered under BMPR 21-08.3 (or current version) or other Department policies, the calibration, verification, standardization and/or check interval shall meet requirements of the applicable test standards. New equipment shall be inspected to verify that it is within allowable tolerances and calibrated prior to use with subsequent calibrations, verifications, standardizations and/or checks performed at the minimum specified intervals.

Two of the most common subsurface exploration tests used by the Department are the Standard Penetration Test (SPT) and the field unconfined compression test (commonly called the Rimac or Q_u test). Equipment calibration, verification, standardization and check requirements for these tests are as follows:

- When conducting an SPT (AASHTO T 206), the energy being delivered from the drill rig’s hammer to the drill rod can vary significantly from one hammer to another. To determine the average hammer efficiency (Energy Transfer Ratio, ETR), hammers used for SPTs shall be tested a minimum of every five years as required for consultant prequalification (see IDOT’s [Description and Minimum Requirements for Prequalification](#) publication under the “Prequalification” drop-down tab). The testing of a drill rig hammer shall be according to ASTM D 4633, “Standard Test Method for Energy Measurement for Dynamic Penetrometers”. This testing is typically performed using specialized equipment and software that monitors the velocity and force delivered from the hammer to the drill rod string.

- Rimac spring testers ([Section 4.4.5.2.1](#)) used to perform field unconfined compression tests shall be inspected and standardized a minimum of every two years in accordance with [CBM Policy Memorandum 21-08.3](#), “Minimum Department and Local Agency Laboratory Requirements for Construction Materials Testing or Mix Design” (Table 2). Standardization of a Rimac can be performed by loading a pre-calibrated spring with a known constant and checking the Rimac load gauge.

The CBM provides calibration, standardization and limited repair services for Department owned Rimacs, nuclear gauges, and slope inclinometers.

4.3 Departmental Subsurface Exploration and Testing Resources

The Department has a variety of subsurface exploration equipment in its inventory. Truck mounted rigs are the most common, and some Districts have all-terrain capabilities. Most Districts staff one drill crew year round with additional crews potentially added in the winter, if and/or when supplemental personnel are available.

The following is list of equipment at the CBM that may be made available for loan to the Districts upon request:

- Slope Inclinometer Equipment (SINCO Company - 1973)
 - AASHTO T 254 Installing, Monitoring, & Processing Data of the Traveling Type Slope Inclinometer
 - ASTM D 6230 Monitoring Ground Movement using Probe-Type Inclinometers
- Soil Stiffness / Modulus Using Geogauge (Humboldt Mfg. Co. – 2005)
- Pile Driving Analyzer (Pile Dynamics, Inc. – PAX model)

4.4 Conducting Subsurface Explorations

The purpose of this section is to provide guidelines to adequately assess the subsurface conditions on highway projects. The success of the subsurface exploration program rests primarily with the personnel in the field who supervise the drilling operation, obtain and test the soil, and prepare the boring logs. These personnel make crucial determinations of site and soil

Geotechnical Manual

Chapter 4 Subsurface Explorations and Field Testing

conditions, based on material encountered in the field. They are required to modify the boring and testing frequency to provide the necessary data, in the time frame allotted. On consultant drilled projects, approval shall be obtained from the DGE prior to proceeding with major deviations from the approved Subsurface Exploration Plan.

Subsurface explorations generally follow AASHTO R 13, "Standard Practice for Conducting Geotechnical Subsurface Investigations" except that Geophysical Surveys are conducted as Special Investigations when required by the DGE.

4.4.1 Advanced Field Preparation

Prior to mobilizing field exploration equipment, decisions should be made that take into account the required amount of information necessary to be gathered for the proposed scope-of-work for a particular project. Cost and feasibility of field explorations as well as property access issues, traffic control, and presence of utilities are also important items that should be considered.

This section is provided to apprise the DGE and the field boring crews, or the consultants for IDOT, of the various requirements for securing subsurface data. The requirements stated herein may not be all inclusive. They are provided as a basis for preparing a checklist of items which should be developed prior to beginning any field studies. This manual does not address sampling or testing requirements of hazardous or special waste materials. The "Manual for Conducting Preliminary Environmental Site Assessments for Illinois Department of Transportation Highway Projects", issued in 1996, contains information on subsurface explorations for some environmental purposes. For further information on special waste (hazardous or non-hazardous) investigations, contact the BD&E.

4.4.1.1 General Requirements

- a) Obtain all permits and licenses from the appropriate authorities. Obtain permission for any work to be done on public or private property.
- b) Identify utilities in the area and maintain a safe working distance from both overhead and buried utilities. If practical, have power lines de-energized and grounded, or temporarily moved.

Geotechnical Manual

Chapter 4 Subsurface Explorations and Field Testing

- c) Determine if any environmental or archeological clearances are required; or commitments exist between IDOT and the property owner, and/or between the State and any other concerned agency.
- d) Review the history of the land use, through IDOT's Land Acquisition Bureau or previous land owner(s), to determine the potential for encountering any hazardous substances during the subsurface exploration.
- e) Inform the drilling crew of any possibility of encountering hazardous substances during the subsurface exploration.
- f) Determine if aquifers will be encountered, and what is the established water table elevation.
- g) Observe and comply with all federal, state, and local laws, ordinances, and regulations which in any manner may affect the conduct of the work.
- h) Ensure proper closure of all bore holes, according to applicable laws and regulations of the State and local agencies. See [Section 4.4.2.2](#) for guidance.
- i) Take reasonable precautions against damage to any public or private property. Document damage, and promptly repair (or make arrangements to pay) for any such damage, according to IDOT requirements.
- j) Determine grubbing or clearing necessary to provide access and working space at the location of each boring.
- k) Ensure the drilling equipment is adequately tooled and powered, to drill and sample all of the anticipated soil and bedrock strata.
- l) Check with the DGE before mobilizing, to determine if special drilling or sampling procedures will be required.
- m) Questions and clarifications should be directed to the DGE. The DGE may then refer the questions to the appropriate Bureau.

4.4.1.2 Subsurface Exploration Plan

Consultant prepared Subsurface Exploration Plans (SEP's) shall be submitted to the DGE for review and approval. In some nonstandard or complex scenarios, the DGE may submit the structures portion of the SEP to the FGU for assistance in their review and approval.

Geotechnical Manual
Chapter 4 Subsurface Explorations and Field Testing

4.4.1.3 Traffic Control

In order to minimize potential hazards to travelers and field personnel, appropriate traffic control shall be provided when exploration activities are conducted adjacent to live traffic. Traffic control shall be in accordance with applicable [IDOT Highway Standards](#) 701001 to 701901 and the [Traffic Control Field Manual](#) (IDOT, 2016).

4.4.1.4 Locating Utilities

All utilities shall be located prior to any subsurface exploration. Most utilities can be located by calling JULIE for downstate projects (outside the limits of the City of Chicago) or DIGGER in the Chicagoland area at the numbers provided in [Table 4.4.1.4-1](#).

Downstate Illinois:	Chicagoland Area:
JULIE https://www.illinois1call.com/ Call 811 or 800-892-0123	DIGGER https://ipi.cityofchicago.org/Digger Call 312-744-7000

Table 4.4.1.4-1 Utility Location Contacts

When practical, boring locations and/or other excavation limits should be pre-marked prior to having utilities located. A minimum notice of 48 hours is required for most utility location requests. For more complex projects, an onsite joint meeting with the utility owners or their prescribed locating companies may be required. However, a “ticket” has to be called in for each utility after a joint meeting. Excavators should have a copy of the dig ticket with them on site.

The District and Municipal operations office should be contacted for the locations of buried highway lighting and traffic signal cables, if drilling in areas likely to contain these cables, since they are not covered by JULIE. Private facilities, such as railroads, are also not covered by JULIE or DIGGER. In these circumstances, utility location should be coordinated with the owner.

Geotechnical Manual

Chapter 4 Subsurface Explorations and Field Testing

4.4.1.5 Permits

The first general requirement listed in [Section 4.4.1.1](#) is to obtain all permits and licenses from the appropriate authorities. This Manual does not cover all the permits and licenses required in detail, and their need shall be determined based on the location and scope of proposed work for a project.

Municipalities often have requirements and permitting processes for performing work with the public right of way, and they should be contacted to determine the requirements for performing subsurface explorations with their limits. One municipality permit requirement example is the [City of Chicago \(2015\)](#), and their Existing Facility Protection (EFP) Review process. This process is under the purview of the Office of Underground Coordination (OUC) within the Chicago Department of Transportation (CDOT), Division of Infrastructure Management. Exploratory borings and excavations of a certain depth within the Freight Tunnel System Area which is bounded by Cermak Road, Halsted Street, Chicago Avenue and Lake Michigan are subject to EFP Review and permitting. This is applicable to all Public Way and private property in that area. Excavations within the City of Chicago that are outside of this boundary may also require permitting and should be verified before beginning subsurface exploration.

4.4.1.6 Property Access and Right of Entry Requirements

When entry onto private property or public property owned by an entity other than the state is required for drilling or access to drilling locations, the property owner and any tenants shall be informed in writing prior to entry as required by [Section 605 ILCS 5/4-503](#) as stated below.

Section [605 ILCS 5/4-503](#):

“For the purpose of making subsurface soil surveys, preliminary surveys and determinations of the amount and extent of such land, rights or other property required, the Department, or any county, by its officers, agents or employees, after written notice to the known owners and occupants, if any, may enter upon the lands or waters of any person, but subject to responsibility for all damages which shall be occasioned thereby.”

Geotechnical Manual

Chapter 4 Subsurface Explorations and Field Testing

District standard practices should be followed for the notification. Although not required, Districts often utilize form letters and include an attachment indicating the proposed drilling locations and alignment over an aerial photo with the affected property highlighted. Notification by Certified Mail is recommended for documentation purposes.

It is advised that field personnel meet or verbally coordinate with the owner and/or tenant to ensure safe access without conflict and disruption. Additional guidance can be found in Section IV of the [IDOT Survey Manual](#) regarding property owner contact and right of entry.

Property entry is subject to all damages which result from such entry under Section [605 ILCS 5/4-503](#). Field crews shall take all reasonable precautions against damage to public or private property. It is advisable to photograph the site before and after performing the work. Any damage incurred shall be documented and promptly repaired (or arrangements made to pay for repairs) in accordance with the Department's policies and practices. The amount of clearing and/or grubbing that may be necessary to provide access and working space at boring locations shall be investigated prior to gaining access to the site. Remunerations for permanently altering a property should be negotiated prior to the commencement of exploration operations when possible.

4.4.1.7 Bridge Decks

In cases where site access is limited, it may be beneficial for borings to be taken through a bridge deck. However, prior approval is required from the district's bureau of Operations Bridge Maintenance Section for all deck coring and depends on the existing superstructure design. Superstructures constructed of precast prestressed concrete deck beams are one example of a deck that cannot be drilled through.

4.4.2 Field Operations Site Control

After borings have been completed, they shall be properly closed and decommissioned in order to avoid future problems for property owners. Proper closure and decommissioning are necessary regardless of the boring location (State ROW, farm field, pasture, yard, etc.). In addition, communication with the property owner is essential in conveying the anticipated site disturbance and mitigation associated with the field exploration.

Geotechnical Manual

Chapter 4 Subsurface Explorations and Field Testing

4.4.2.1 Boring and Excavation Pit Closure

The following are recommended procedures for backfilling geotechnical borings. These are intended for the typical situations indicated only. When greater than normal potential for contamination exists, the DGE should be contacted to determine the need for additional seals. Additionally, it is important for drillers to be familiar with AASHTO R 22, "Standard Practice for Decommissioning Geotechnical Exploratory Boreholes" and AASHTO R 21, "Standard Practice for Drilling for Subsurface Investigations - Unexpectedly Encountering Suspected Hazardous Material".

- a) Borings made in cohesive soils where no aquifers are encountered may be backfilled with auger cuttings.
- b) Borings that intersect aquifers shall be backfilled with impervious grout seal or bentonite clay plug, at the top of each aquifer intersected, as the hollow stem augers or casings are extracted from a completed boring. The remainder of the hole may be backfilled with auger cuttings.
- c) Borings in alluvial valleys shall be backfilled with an impervious grout seal or bentonite clay plug, established at the water table elevation, as the hollow stem augers or casings are extracted from a completed boring. The remainder of the hole may be backfilled with auger cuttings.
- d) Borings where artesian conditions are encountered shall be sealed with an impervious grout seal or a bentonite clay plug as soon as possible and at no time allowed to stay open overnight.
- e) Borings in pavements and slabs shall be filled at the surface with quick setting concrete, or with cold mix asphalt, as appropriate.

All impervious grout seals or bentonite clay plugs shall be constructed to prevent surface water, or water from shallow perched water tables from entering into aquifers, as well as prevent migration of water between aquifers.

Any excavation pits used for the purpose of bulk sampling shall be backfilled with the excavated or other suitable material, and properly compacted as required. This will be dependent on the location of the excavation and the potential risk of the disturbance or excessive movements.

Geotechnical Manual

Chapter 4 Subsurface Explorations and Field Testing

4.4.2.2 Site Cleanup

Disturbance of a site exploration area is often inevitable. Efforts should be made to minimize disturbance, and care should be taken to leave the site in a condition similar to that found upon arrival. Settling of borehole backfill material is common, and follow up inspections of the site may be required to determine when settlement is complete. Excess cuttings should be removed from the site when the majority of the settlement is believed to have stopped. However, excess cuttings should be removed from pavements, sidewalks, and other location as appropriate once the boring is completed. If there is not enough material to properly backfill the borehole after it has settled, additional material should be brought in. Settlements at the surfaces of pavements and sidewalks shall be refilled at the surface with quick setting concrete, or with cold mix asphalt, as appropriate.

When drilling in a remote location, disposal of drilling fluid adjacent to the borehole is common. However, this is not allowed when drilling in a property owner's yard. Methods of controlling and disposing drilling fluid should be identified prior to drilling. In addition, all waste such as laths, empty bentonite or cement bags, and all other debris generated by the field exploration shall be removed from the site and disposed of properly.

4.4.3 (Reserved)

4.4.4 Sampling

This section discusses techniques most frequently performed during the course of subsurface explorations for obtain samples ranging from disturbed, moderately disturbed, to intact (relatively undisturbed) states. The selection of the sampling method depends on the purpose which the sample is anticipated to be utilized.

4.4.4.1 – 4.4.4.5 (Reserved)

Geotechnical Manual

Chapter 4 Subsurface Explorations and Field Testing

4.4.4.6 Shelby Tubes

Shelby tube samples are pushed in order to obtain intact (relatively undisturbed) soil samples suitable for laboratory testing of engineering properties, such as consolidation and/or triaxial testing.

The Shelby tube sampling is to be conducted according to AASHTO T 207, "Standard Method of Test for Thin-Walled Tube Sampling". If other intact (relatively undisturbed) sampling systems are used, at the discretion of the DGE, the area ratio (A_r) defined by [Equation 4.4.4.7-1](#) must not exceed 30%.

Shelby tube sampling is a method used to obtain intact (relatively undisturbed) soil samples in cohesive materials, where it is not desirable to use the split-spoon method for sampling. Less sample disturbance results from Shelby tube sampling for two reasons: 1) the tube has very thin walls. For a 2 in. (50.8 mm) diameter tube, the wall thickness is only 0.062 in. (1.57 mm), compared to a split-spoon wall thickness of 0.312 in. (7.92 mm); and 2) the sampler tube is hydraulically pressed into the soil, rather than being driven with the accompanying vibrations.

Any size of tube may be used, but 3 in. (76.2 mm) outside diameter tubes or larger are preferred, for samples of good quality. The tube diameter is controlled by the inside diameter of the bore hole, or the casing being used. It is common, to use 3 in. (76.2 mm) diameter by 3 ft. (0.91 m) long tubes. The tubes are forced into the strata with a steady hydraulic force. The comments pertaining to subsoil disturbance and the need for a clean hole are equally as applicable for Shelby tube sampling, as for split-spoon sampling. The tube should be pushed 2.5 ft., turned one revolution, and retracted from the hole. However, sample recovery may be improved in soft soils by delaying withdrawal of the sampler (typically 5 to 30 minutes). After withdrawal, the ends of the tube are then examined for classification purposes, sealed with paraffin, and labeled for shipment to the soils laboratory. The hole is further advanced 2.5 ft., if another sample is to be taken.

The Shelby tube samples are used for laboratory unconfined compression, triaxial, consolidation and classification testing. Therefore, it is important that the tubes be properly sealed to prevent moisture loss, protected from vibration and shock, and protected from freezing and extreme heat

Geotechnical Manual

Chapter 4 Subsurface Explorations and Field Testing

during shipment to the laboratory. Tubes tend to rust rapidly, both on the inside and outside. Therefore, shipment and testing should be done as rapidly as possible.

Pushing a Shelby tube within the same borehole used for the SPT that revealed the weak cohesive soil is not allowed. A Shelby tube boring should be performed adjacent to the SPT borehole in order to sample at the same elevation that the weak layer was encountered.

4.4.4.7 Other Intact (Relatively Undisturbed) Sampling Systems

Other intact (relatively undisturbed) sampling systems may also be used as an alternative to Shelby tubes at the discretion of the DGE. If these systems are used, the wall thickness of the tubes should result in an area ratio (A_r) which does not exceed 30%. The sampling is to be conducted according to AASHTO T 207, "Standard Method of Test for Thin-Walled Tube Sampling".

The area ratio is defined as the ratio of the volume of soil displacement, to the volume of the collected sample, and it is expressed as:

$$A_r (\%) = \frac{D_o^2 - D_i^2}{D_i^2} \times 100 \quad (\text{Eq. 4.4.4.7-1})$$

Where:

A_r = area ratio

D_o = Outside diameter of tube

D_i = Inside diameter of cutting edge

An area ratio of 100% means that the *in situ* soil was displaced by a volume equal to that of the collected sample. Well-designed tubes have an A_r less than 10%.

4.4.4.8 – 4.4.4.9 (Reserved)

Geotechnical Manual

Chapter 4 Subsurface Explorations and Field Testing

4.4.5 In Situ and Field Tests

This section discusses the *in situ* and field tests most frequently performed during the course of subsurface explorations.

4.4.5.1 Borehole *In Situ* Tests

In situ tests discussed in the following sub-sections are test conducted on soils while they are “in place” or within the ground.

4.4.5.1.1 Standard Penetration Test

The SPT test is to be conducted according to AASHTO T 206, “Standard Method of Test for Penetration Test and Split-Barrel Sampling of Soils”. SPT utilizes a sampling device known as a split-spoon or split-barrel sampler. The device is approximately 2.5 ft. long, with an outside diameter of 2 in., and an inside diameter of 1.375 in. It consists of, a drive shoe, split barrel, and a head which is attached to the drill rods. A variation of the split barrel is the solid barrel (with a split insert liner).

The SPT is, normally, made at 2.5 ft. intervals. The number of blows, N, required to drive the split-spoon 12 in., with a hammer weighing 140 lb., and falling free from a height of 2.5 ft. is known as: the standard penetration resistance. Therefore, the SPT consists of driving the sampler into soil, and recording the blow count.

Any method of advancing the drill hole is permissible; provided that the hole is cleaned to the sampling elevation, prior to sampling; and that the soil to be sampled is not disturbed, by the process of making the hole. The sampler is first driven 6 in. below the bottom of the hole, to insure proper seating. Then, it is driven an additional two, 6 in. increments. The number of blows, to drive each of the 6 in. increments is recorded on the field log. The sum of the latter two increments is the N value.

The SPT is performed for two, primary, purposes: 1) to obtain a representative sample of the subsoil strata for purposes of identification, classification, unconfined compression testing,

Geotechnical Manual

Chapter 4 Subsurface Explorations and Field Testing

moisture and density tests; and 2) to obtain a measure of the relative density and/or consistency of the soils discussed in [Section 4.4.6.1.2](#). It is the only simple, widely used test, presently available, to determine design data for cohesionless soils.

It must be emphasized, that the quality of sample obtained and, therefore, the degree of accuracy of the unconfined compression test, and finally the design of the structure are all dependent on the care used in performing the test. Therefore, it is important that the hole is clean, that the soil below the hole is relatively undisturbed, that the hammer falls freely (not more than 2 1/4 rope turns on the cathead), and that the split-spoon be in good condition. Any rock or foreign object encountered that affects the blow count must be noted on the boring logs, along with the water level data. If the automatic hammer is used, the hammer casing should be kept clean, and free from soil and rock particles, or foreign objects. IDOT mostly uses the automatic hammer which typically provides an efficiency of 85 to 95%, compared to the rope and cathead type with about 60% efficiency. Therefore, an energy correction, or hammer energy measurement according to ASTM D 4633 ([Section 4.2](#)) is needed for liquefaction analysis.

4.4.5.1.2 Vane Shear Test

The vane shear test is to be conducted according to AASHTO T 223, "Field Vane Shear Test in Cohesive Soil". The vane shear test was developed as a means of determining the *in situ* shear strength of cohesive soils which are quite soft or easily disturbed by conventional sampling operations. Therefore, the test is limited to soft or medium stiff, saturated, clayey soils.

The vane shear test consists of manually pushing a four-bladed vane, into the undisturbed soil, and rotating the vane from the surface; to determine the torsional force required to cause a cylindrical surface sheared by the vane. The torsional force is then converted, to a unit shearing resistance around the cylindrical surface sheared. After the test of the undisturbed soil is completed, a remolded shearing strength is, usually, obtained; by turning the vane rapidly through several revolutions, and then measuring the torsional force required to shear the remolded soil.

The vane shear test has the distinct advantage of very little sample disturbance, before testing. However, some disadvantages also exist, particularly: 1) Unless a nearby soil boring was already drilled, the type of soil being tested is, usually, unknown until after the test is over, and the hole is

Geotechnical Manual

Chapter 4 Subsurface Explorations and Field Testing

advanced past the elevation tested; and 2) the test is, usually, limited to the weaker soils, which are free of pebbles or stones.

Soils which will permit drainage or dilate, during the test, are not appropriately tested by the vane apparatus. Normally, vane tests are performed at 2.5 ft. intervals, throughout the soft cohesive soil stratum.

Friction in the vane rod and instrument should be accounted for. Otherwise, the friction would be improperly recorded as soil strength. Friction under no-load conditions (such as use of a vane that allows a partial turn of free rotation prior to loading), must be determined. No side thrust in the measuring device, under peak load, should be permitted. Side thrust results in a change of frictional conditions. As in the case of the hand penetrometer, several readings should be taken, and engineering judgment applied to the results.

4.4.5.2 Field Tests on Samples

The field tests discussed in the following sub-sections are conducted on samples after they are extracted from the ground.

4.4.5.2.1 Rimac Unconfined Compressive Test

This test is performed, in the field, on cohesive soils obtained from split-spoon samplers. The test is relatively quick, simple, and more accurate than the pp. The test is performed according to the test procedure in [Appendix C.1](#), "Field Test Procedure for Unconfined Compressive Strength of Cohesive Soil (Rimac)", using a Rimac spring tester [[Figures 4.4.5.2.1-1\(a\)](#) and [\(b\)](#)]. The apparatus was originally developed for testing automobile valve springs. However, IDOT has modified the apparatus, by changing the gears to give a slower deformation rate for soil testing. A copy of the shop drawing, for changing the gears, can be obtained from the CBM's Geotechnical Engineer.

The operator obtains a reasonably intact specimen from a split-spoon sampler; and measures the dimensions after carefully trimming the length. The sample is placed between the platens of the Rimac tester (in an upright position), and a slow, continuous, uniform load is applied to the sample.

Geotechnical Manual

Chapter 4 Subsurface Explorations and Field Testing

The rate of load application is one complete handle revolution, every 12 seconds (5 rpm). The average time, per test, ranges from 3 to 6 minutes. This rate of load application must be used. Since this test is relied on for “initial” stability analysis, according to [Sections 6.4.3](#), [6.10.3](#) and [7.3.3.6](#), it is a critical test in the boring operation and should not be hurried.

The Rimac test is considered more accurate than the pp test. However, there are several factors that influence the Rimac Q_u data. These factors include: the condition of the Rimac tester, sample dimensions, the method and rate of loading, and type of soil. Since Rimac test procedure is hand operated, the test results may be inconsistent, due to human error, and may vary significantly for the same soil. Periodic calibration verification of the equipment is necessary to ensure consistency and data validation over a long period of time. The calibration verification can be performed in the lab by loading a precalibrated spring, with a known constant, using the Rimac tester to be calibrated. If the Rimac load gauge provides the same spring constant, no adjustment is needed. Otherwise, the Rimac gauge must be adjusted to reflect the correct load.

[Table C.1-1](#) is provided in [Appendix C.1](#) for converting Rimac load readings to Q_u values. Alternatively, and for sample sizes not included in the Appendix, the Rimac load readings can be converted to Q_u values using the formulas found in the test procedure outlined in [Appendix C.1](#).

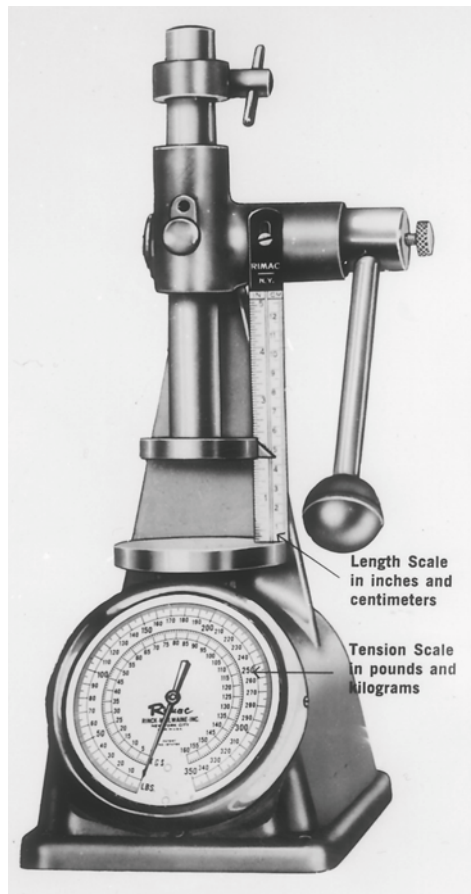

Figure 4.4.5.2.1-1(a) Rimac Spring Tester without gearbox modification
(Contact the CBM if a Shop Drawing for gear modification is desired).

Geotechnical Manual
Chapter 4 Subsurface Explorations and Field Testing



Figure 4.4.5.2.1-1(b) Rimac Spring Tester and Soil Sample

Geotechnical Manual

Chapter 4 Subsurface Explorations and Field Testing

4.4.5.2.2 Pocket Penetrometer

A commonly used approximation of the unconfined compression test is performed by using a hand size calibrated penetration device, called a pocket or hand penetrometer. This device consists of a calibrated spring and a 0.25 in. diameter piston, both encased inside a metal casing. The test is, usually, performed in the field, on split-spoon soil samples or, sometimes, an auger cutting. When the piston is forced, by hand, to penetrate into the soil sample a distance of 0.25 in., at a constant rate, the calibrated spring is compressed into the penetrometer; giving an unconfined compression strength, or Q_u reading, on a scale. The pp values should not be used for design recommendations, stability or settlement analyses. It may only be used for an initial estimate of subgrade soil treatment depth, in the absence of other more accurate data.

The use of a pp is valuable only as a guide (or supplement) to more precise strength determinations. The strength value obtained is influenced by the extremely small area of the piston, the skill of the operator, and the particular spot on the sample where the piston is applied. For example, if small pebbles are present in the sample, several hundred percent strength difference may be obtained from the same specimen, depending upon where the piston is inserted. Therefore, the test results for hard glacial tills, commonly encountered in Illinois, are questionable. The test might be well suited for soft to medium stiff clays. Thus, several penetrometer readings should be taken, on the same specimen, and on different specimens; and engineering judgment applied to their results, if an intelligent estimate of soil strength is to be made from penetrometer readings. More precise testing methods should be used whenever possible.

Geotechnical Manual

Chapter 4 Subsurface Explorations and Field Testing

4.4.5.3 Penetrometer Tests

4.4.5.3.1 Cone Penetrometer Testing

The CPT is a mechanical or an electronic cone penetration test, which is to be conducted according to ASTM D 3441, "Standard Test Method for Mechanical Cone Penetration Tests of Soil" or ASTM D 5778, "Standard Test Method for Electronic Friction Cone and Piezocone Penetration Testing of Soils". The test is, sometimes, referred to as the "Dutch Cone Test", since it was originated in the Netherlands. The quasi-static CPT includes the use of both cone and friction cone (sleeve) penetrometers for measuring the tip resistance and sleeve friction, respectively. The improvements in transducer technology have further led to the development of the piezocone for measuring the pore pressure during penetration, in addition to the tip resistance and sleeve friction. Later, the seismic cone was developed to measure the dynamic shear modulus.

Using the electronic data acquisition equipment, the CPT can be used to rapidly obtain continuous soil profile including soil description, cohesion, friction angle and pore pressure data with depth. The test is performed by pushing the standard cone [with 60° apex angle, 1.4 in. (35.7 mm) base diameter and 1.55 in.² (1000 mm²) projected area] into the ground at a rate of 0.4 to 0.8 in./sec. (10 to 20 mm/sec.). Data is recorded continuously with depth at intervals not exceeding 8 in. (200 mm).

The CPT has been used for estimating the soil shear strength, pile capacity, liquefaction potential, and for providing classification of various soil deposits as well as data for different design problems. However, the CPT has the disadvantages of not obtaining a soil sample for visual identification or laboratory testing. Also, it can only be used in soft clays and fine to medium sands. The test cannot be used in gravels and stiff to hard clays.

CPT tests are rarely conducted in Illinois. This test shall be conducted by persons with demonstrated CPT testing and design experience and only with approval from the DGE.

Geotechnical Manual

Chapter 4 Subsurface Explorations and Field Testing

4.4.5.3.2 Dynamic Cone Penetrometer

The Dynamic Cone Penetrometer (DCP) test is predominantly used for construction inspection of subgrades. However, it can be used during subsurface explorations for certain applications such as preliminary estimation of *in situ* soil strengths for treatment assessments of subgrades and culverts. Refer to [Section 4.7.2.1](#) for discussion on the DCP test and the [Subgrade Stability Manual](#) for additional information on correlation of DCP test results with soil strength and guidance on subgrade treatments.

4.4.5.3.3 Static Cone Penetrometer

The Static Cone Penetrometer (SCP) test is predominantly used for construction inspection of subgrades. However, it can be used during exploration for preliminary estimation of *in situ* soil strengths for subgrade treatment assessments in certain applications. Refer to [Section 4.7.2.2](#) for discussion on the SCP test and the [Subgrade Stability Manual](#) for additional information on correlation of SCP test results with soil strength and guidance on subgrade treatments.

4.4.6 Characterization of Earth Materials

This section discusses the various methods for identifying and describing soil and rock samples.

4.4.6.1 Soil Characterization

The soil characteristics of particular interest to engineers are typically the type of soil and its *in situ* properties. Samples are **identified** in the field by visual-manual procedures. Then soil types are **classified** through laboratory testing for the AASHTO classification system and the Illinois Division of Highways (IDH) Textural Classification Chart shown in [Figure 5.5.5.1-1](#). The *in situ* properties generally refer to the moisture content, relative density or consistency, and strength.

Geotechnical Manual

Chapter 4 Subsurface Explorations and Field Testing

4.4.6.1.1 Field Identification of Soils

Accurate identification of soil samples is to be made in the laboratory according to the methods described in [Section 5.5.5](#). However, due to the lack of necessary facilities in the field to accurately classify the soil, field identification of soil primarily depends on visual-manual identification procedures. This consists of some visual and simple physical tests of the soil's color, odor, particle size, plasticity, structure, and moisture. Experience is an important factor in identifying the soil as accurately as possible. Therefore, field identification of soils should only be considered as a preliminary, approximate information about the *in situ* soil stratification. For any design recommendations, or for changing certain construction procedures, field identification must always be confirmed by laboratory tests.

As soil samples are extracted from borings, test pits or road cuts, they should approximately be identified in the field; in terms of texture, color and engineering classification. Field identification of soil is performed by adapting the procedures in ASTM D 2488, "Standard Practice for Description and Identification of Soil (Visual-Manual Procedure)" for use with the IDH Textural Classification Chart in [Figure 5.5.5.1-1](#).

As an aid in field identification, [Table 5.5.5.1-1](#) shows the particle size limits for different soil constituents. This table can be used in the field mainly as a guide to distinguish between fine and coarse sand or between fine and coarse gravel since sieve analysis is performed in the laboratory. A flow chart is also provided in [Figure 4.4.6.1.1-1](#) to serve as a general guide for identifying clayey, silty, and sandy soils according to the IDH Textural Classification Chart in [Figure 5.5.5.1-1](#), as well as, organic silt, organic clay and peat. Organic soils are usually identified by their dark color (dark gray, dark brown, or black), and their somewhat musty, decayed odor. It is, usually, possible to visually identify small vegetable, root, or leaf particles present in organic soils.

Geotechnical Manual
Chapter 4 Subsurface Explorations and Field Testing

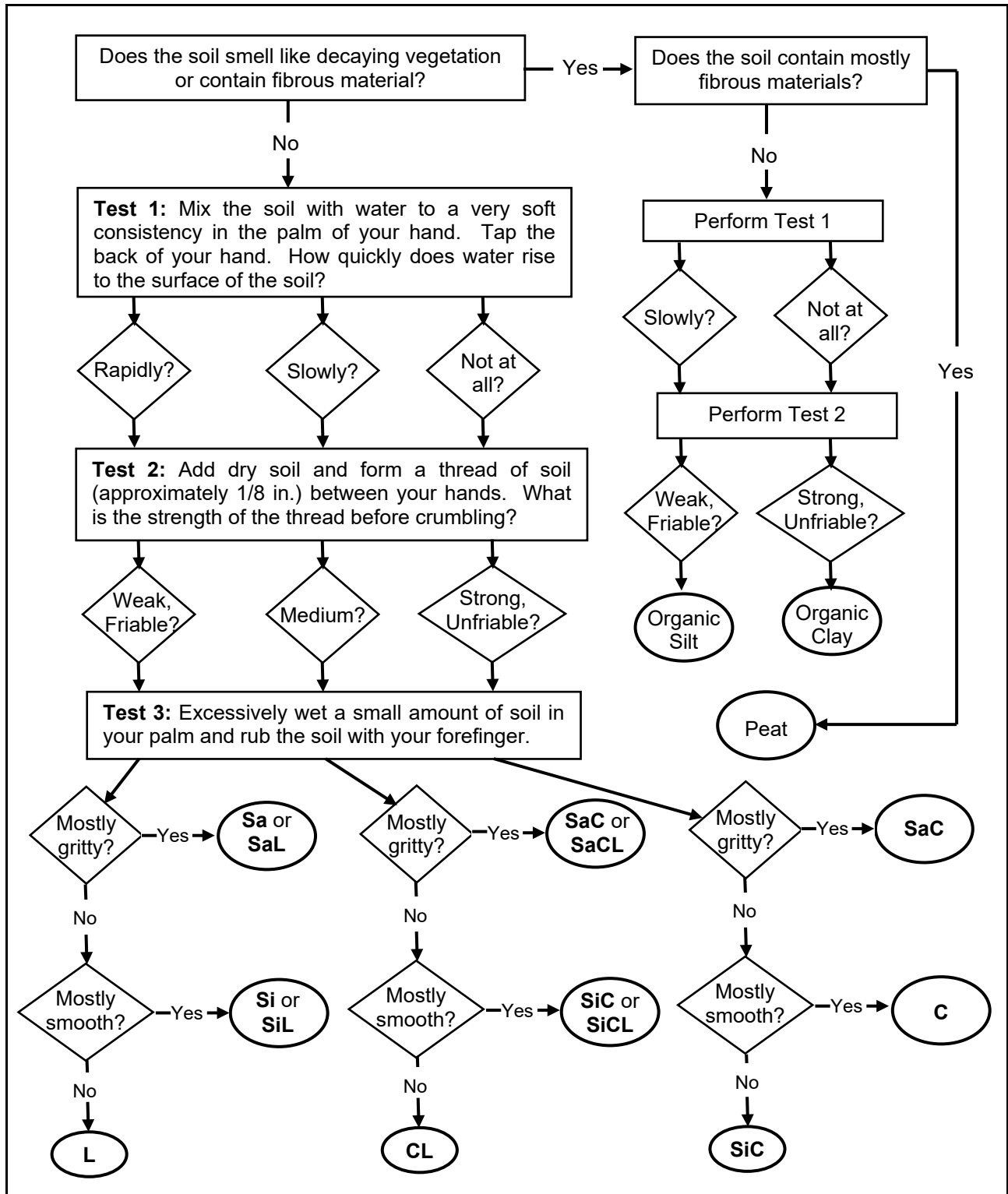

Figure 4.4.6.1.1-1 Simplified Flow Chart for Field Identification of Soils

Geotechnical Manual

Chapter 4 Subsurface Explorations and Field Testing

4.4.6.1.2 Consistency and Relative Density

Soil descriptions of SPT samples also include the relative density or consistency of the material. The results of a SPT test can usually be correlated, in a general way, with the relative density of granular cohesionless soils; and, in a less reliable way, with the consistency or compressive strength of fine grained cohesive soils.

A fairly reliable correlation of N , with the relative density and friction angle, ϕ , for granular soils is shown in [Table 4.4.6.1.2-1](#). The relative density correlations with the N -values in [Table 4.4.6.1.2-1](#) shall be used for the soil descriptions on the boring logs. However, some engineering analyses, such as seismic liquefaction analyses, may require the internal friction angle of cohesionless soils correlated from N -values to be corrected for the effects of overburden pressure and hammer efficiency (N_{160}). For these applications, Article 10.4.6.2.4 of the “*AASHTO LRFD Bridge Design Specifications*” ([AASHTO, 2020](#)) provides formulas for determining these adjustments to obtain N_{160} and their correlations to drained friction angles of granular soils.

The correlation of N , with consistency and strength in cohesive soils, should be used only in the general descriptive manner as shown in [Table 4.4.6.1.2-2](#). In this table, the consistency and strength correlations are very poor, because of: variations in over consolidation ratio (OCR), aging, moisture content, use (or lack of use) of drilling fluid for sampling, pore pressures and groundwater table. Correlations between consistency and the unconfined compressive strength, Q_u , determined using Rimac or laboratory unconfined compression testing is generally considered a more reliable correlation.

Note that the correlations shown in [Tables 4.4.6.1.2-1](#) and [4.4.6.1.2-2](#) were developed at that time that SPTs were performed predominately with rope and cathead methods which are less efficient than auto-hammers. As such, the uncorrected N -values in these tables are likely to be closer to 60% efficiency (N_{60}), and engineering judgement should be used when applying correlations.

Geotechnical Manual
Chapter 4 Subsurface Explorations and Field Testing

Relative Density and Friction Angle as a Function of the N-Value		
N Value	Relative Density	Friction Angle*, ϕ , Deg.
0 - 4	Very Loose	26 - 30
4 - 10	Loose	28 - 34
10 - 30	Medium Dense	30 - 40
30 - 50	Dense	33 - 45
Over 50	Very Dense	≤ 50
* Lower limits are for fine, clean sand; and should be reduced by up to 5° for silty sands. The upper limits are for coarse clean sands.		

Table 4.4.6.1.2-1 Relative Density and Friction Angle of Cohesionless Soils

Strength and Consistency as a Function of the N-Value		
N Value	Consistency	Strength*, Q_u , tsf
< 2	Very Soft	< 0.25
2 - 4	Soft	0.25 - 0.50
4 - 8	Medium Stiff	0.50 - 1.0
8 - 15	Stiff	1.0 - 2.0
15 - 30	Very Stiff	2.0 - 4.0
> 30	Hard	4.0 - 8.0
* Not an exact conversion.		

Table 4.4.6.1.2-2 Strength and Consistency of Cohesive Soils

4.4.6.2 Rock Characterization

Rock can be characterized in many ways depending on the desired use of the information. For highway design purposes, rock samples are typically collected in the field by coring to identify the rock type, condition, and strength.

Geotechnical Manual

Chapter 4 Subsurface Explorations and Field Testing

4.4.6.2.1 Field Identification of Rock

In rock mechanics, it necessary to distinguish between rock mass and a rock sample. A rock sample is the material between any structural discontinuities in a rock mass. Rock mass is the aggregate of regular or irregular blocks of rock material. The blocks are separated by structural features such as bedding planes, joints, fissures, cavities and other discontinuities. This means that identification of a rock sample, in terms of strength or integrity, may not reflect the same characteristics as the entire rock mass. Therefore, as a minimum, field identification of rock should include:

- Rock type (such as, dolomite, limestone, shale, sandstone)
- Color (which might be affected with moisture condition)
- Moisture condition (wet or dry)
- Grain size and shape (such as, coarse grained, angular or fine grained, rounded)
- Texture (stratification/foliation, such as thin-bedded)
- Mineral composition (if an experienced geologist is conducting the identification)
- Weathering and alteration
- Rock quality (based on the Rock Quality Designation for rock cores)
- Core recovery ratio (for rock cores)
- Strength (weak or strong – based on experience, otherwise, test rock samples in lab)
- Other relevant notes (such as presence of foreign material)

Sedimentary rocks are the most common strata in Illinois, although some igneous and metamorphic rocks may be encountered in southern Illinois. [Table 4.4.6.2.1-1](#) provides a guideline for basic sedimentary rock identification.

Geotechnical Manual
Chapter 4 Subsurface Explorations and Field Testing

Description	Individual Grain Size	Cementation or Hardness	Layered Grains*	Reaction with HCl
Sandstone	Visible 0.075 to 4.75 mm	Weak to Strong	No	No
Siltstone	Visible 0.002 to 0.075 mm	Weak to Strong	No	No
Shale	Not Visible	Soft to Hard	Yes	No
Mudstone or Claystone	Not Visible	Soft to Hard	No	No
Limestone	Not Visible	Hard	No	Rapid
Dolomite	Not Visible	Hard	No	Slow
* Nearly all sedimentary rocks show evidence of stratification. Shales show layering of the grains.				

Table 4.4.6.2.1-1 Basic Sedimentary Rock Identification

4.4.6.2.2 Core Recovery Ratio and Rock Quality Designation

When rock cores are obtained, it is important to measure the core recovery and the Rock Quality Designation (RQD). The core recovery ratio is the length of rock core recovered from a core run, divided by the total length of the core run. This ratio, expressed in percent, provides indications regarding the presence of weathered zones, plugging during drilling, loss of fluid, and recut or rolled pieces of core.

The RQD of a core run is determined according to ASTM D 6032, "Standard Test Method for Determining Rock Quality Designation (RQD) of Rock Core". The RQD, expressed in percent, is the sum of the lengths of all pieces of sound core equal to or greater than 4 in. long, recovered from a core run, divided by the total length of the core run. For example, if the core run is 60 in., length recovered is 40 in., and there are 10 rock pieces, 7 of which with lengths less than 4 in. and 3 pieces with lengths of 4 in., 5.5 in. and 6 in., respectively. The RQD for this core is 25.8% where $[(4 \text{ in.} + 5.5 \text{ in.} + 6 \text{ in.})/60 \text{ in.}] \times 100\% = 25.8\%$. The piece length is an average length which should be measured at the midpoints on each end. The RQD should be determined as

Geotechnical Manual

Chapter 4 Subsurface Explorations and Field Testing

soon as the core is extracted. When determining the RQD, mechanical breaks caused by the drilling process, usually evident by rough fresh surfaces, should be counted as one piece.

There are correlations between the RQD and the average quality and strength of a rock mass. [Table 4.4.6.2.2-1](#) shows a correlation between RQD and rock quality. For information on other correlations for different rock types, see Arman et al. (1997).

RQD, %	Rock Quality
90 - 100	Excellent
75 - 90	Good
50 - 75	Fair
25 - 50	Poor
0 - 25	Very Poor

Table 4.4.6.2.2-1 Relation of RQD to In situ Rock Quality

4.4.6.2.3 Rock Strength

The compressive strength of a rock specimen is determined in the laboratory using the uniaxial compressive strength test as discussed in [Section 5.5.12](#). The moisture content is also typically determined with the compressive strength test specimens. If the rock core has pieces of sufficient size for testing, multiple specimens should be tested in each core run to assess the variability of strength throughout the core.

Geotechnical Manual

Chapter 4 Subsurface Explorations and Field Testing

4.4.7 Documentation of Exploration Records

Accurate and thorough documentation is required for each subsurface exploration. The following discussion provides guidance on preparing documentation of subsurface exploration data. These sub-sections do not include more specialized operations such as geophysical surveys, *in situ* instrumentation/monitoring programs, or general construction materials field testing.

4.4.7.1 Boring Logs

Boring logs are used to document subsurface exploration data and some corresponding laboratory test results. During a subsurface exploration, field logs are used to record the boring operation and field test data. The field logs and subsequent laboratory tests are then used to develop final logs. There are two IDOT forms available for use as final boring logs:

- [BBS 137](#): Soil Boring Log
- [BBS 138](#): Rock Core Log

The applicability of these forms to a given project will be dependent upon the sampling method, and types of field and laboratory tests conducted. These forms and others are available in Microsoft Word format on the IDOT website <http://www.idot.illinois.gov/> under the “Forms” tab on the **Soils page** (navigational path: [Home > Doing Business > Material Approvals > Soils](#)). Soil boring and rock core data can also be entered into a gINT project file ([Section 4.4.7.3](#)) for use in the development of logs and profiles.

4.4.7.1.1 Field Logs

Field logs are records prepared by the logger during the execution of field subsurface explorations. The field logs document information about the project, field personnel, exploration methods, equipment, subsurface materials (visual description), groundwater conditions, *in situ* and field testing, installation of any monitoring equipment, and other applicable data from an exploratory test location (hole, pit, or cut). Since there are numerous details to be recorded, ASTM D 5434, “Standard Guide for Field Logging of Subsurface Explorations of Soil and Rock” should be referred to for guidance.

Geotechnical Manual

Chapter 4 Subsurface Explorations and Field Testing

Field logs shall have adequate space for the logger to make notes and record all the necessary project information, location information, descriptions of the character of drilling and any difficulties encountered, field test data, and soil or rock descriptions. All soil and rock samples shall be observed and described immediately upon recovery. The field logs should be identified in a logical fashion that can be easily referred to during the preparation of final logs or other reports. Field logs are original documents, and they may be requested for review if questions arise during design or construction and, as such, should be retained on file until construction is completed. Dated notes should be provided on the field log where modifications or clarifications have been made in the preparation of the final logs indicating the reason for the change. Consultants performing field explorations and drilling shall submit copies of original field logs to the DGE upon request.

In addition to the project and location information, the field log should contain the following subsurface data:

1. Provide a description of each soil sample in terms of color, relative moisture (dry, moist, or wet), and texture. Include visual-manual descriptions of soil samples according to the IDH textural classification chart ([Figure 5.5.5.1-1](#)). When encountered, describe pavement type and thickness, type and relative amounts of organics, debris, gravels, cobbles, and etcetera. Rock should be described in terms of type, color, cementation, weathering, condition information, abnormalities, and the like ([Section 4.4.6.2.1](#)).
2. Record the top and bottom elevation or depth of each soil or rock layer. Depths must be converted to elevations for the final log.
3. Where applicable, record SPT blow count data, Q_u (indicate shear – with % deformation at failure, bulge, penetrometer, or estimate), and moisture content. Include the limits of the sampled material. When coring in rock, the field log should include recovery, RQD, and core time ([Section 4.4.6.2.2](#)). Color photographs of the cores (prior to preparing for transport) shall also be taken and shown with a tape measure for scale.

Geotechnical Manual

Chapter 4 Subsurface Explorations and Field Testing

4. Record 1) the depth that “free” water is first encountered during drilling, 2) the depth to water in a borehole at completion of drilling, and 3) the depth to water in a borehole 24 hours (or other delayed time) after drilling has been completed. If a seepage zone is encountered, record the depth and time encountered in the body (description area) of the log.

If it is observed that groundwater is 1) not encountered during drilling, 2) not present in the boring upon completion of drilling, or 3) found to not be present at a delayed (24 hr. or other) reading, it shall be reported as “Dry” for that particular observation/reading. The term “Dry” in this case means that no “free” water is present in the borehole upon inspection; however, a groundwater table may exist even though it does not present “free” water at that time of observation. If a borehole collapse is observed when obtaining a reading, the depth to collapse shall also be reported on the log (e.g.: “Caved @ XX’ ”). If a groundwater level observation/reading was not performed, record “Not Taken” on the log along with reason for not being taken. Terms such as “Washed”, “Mud Rotary”, and “Cored” may be recorded in lieu of a measured depth if the type of drilling activity introduces water and other materials into a borehole and affects the water level reading reliability or hinders the ability to take the reading. The term “Filled” may also be reported for the delayed (___ hr.) reading if a borehole was filled shortly after completion of drilling instead of leaving it open for obtaining a delayed reading. If there is not enough room in the space given to record water level information and/or notes, an asterisk (*) should be used and linked to an explanation in the body (description area) of the log.

The elevation of any surface water such as adjacent lakes, rivers, ponds and wetlands shall also be obtained and recorded, if accessible, as it may correlate with the groundwater table and provide designers as well as contractors with further insight on where the groundwater may be encountered. This information is particularly important for drilled shafts, cofferdams and other excavations. For bridges and box culverts, the flow line (stream bed) elevation at the upstream or downstream ends shall also be recorded, if accessible.

Geotechnical Manual

Chapter 4 Subsurface Explorations and Field Testing

5. Include notes indicating drilling methods and equipment, changes in drilling method, problems encountered, and method of backfilling. Some possible example notes are:
- “Encountered sand blowing up 5 ft. into hollow stem auger”
 - “Washed prior to sampling”
 - “Encountered flowing artesian conditions at 80 ft., began bentonite slurry drilling”
 - “Hole sealed with cement bentonite grout”

4.4.7.1.2 Soil Boring Logs

Soil Boring Logs provide the final typed description of exploration procedures and subsurface conditions encountered during drilling/sampling in soil or soft rock, and pertinent data that will be used during design.

The importance of the accuracy, completeness, and consistency of sampling, testing, and reporting procedures cannot be overemphasized. Boring logs must be accurate for the designer to know the exact classification properties of the subsoil which impact the design. The information must be complete, including all weak subsoil strata which affect the foundation. Consistent descriptive nomenclature must also be used.

The field boring log is a form submitted by the drill crew supervisor (or geologist), to the geotechnical engineer in charge of preparing the Geotechnical Report. In order to properly complete the standard soil boring log, on [Figure 4.4.7.1.2-1](#), the physical properties and arrangement of the subsoil layers should be fully described on the field boring log. The standard boring log shall be typewritten and contain the following information, as applicable:

Geotechnical Manual

Chapter 4 Subsurface Explorations and Field Testing

- a) Structure Number.
- b) Route.
- c) Section.
- d) County.
- e) Description of bridge, cut, or embankment.
- f) Station of bridge, cut, or embankment.
- g) Date the boring was completed.
- h) Name of the field personnel completing the field log, and name of the District (or the geotechnical consultant).
- i) Identification number for that particular boring.
- j) Station of boring, on route listed under Item b) above.
- k) Offset from centerline, of route listed under Item b) above.
- l) Latitude and Longitude of boring location.
- m) Surface water elevation should be indicated for all borings on shores of rivers, lakes, ponds and wetlands.
- n) The elevation of any water first encountered during drilling and at completion of boring. (See [Section 4.6.1](#) for groundwater observation.)
- o) Indicate the groundwater elevation at 24 hours (or other delayed reading time) after completion of boring, when practical. If the observation is made at another time, give the number of hours that have elapsed. Also, indicate if groundwater was not present, present but not measured, or a borehole collapse (with depth) was observed using the terminology presented in [Section 4.4.7.1.1](#).
- p) For each groundwater measurement (first encountered, on completion, and after 24 hours), display a symbol adjacent to the vertical depth scale on the log.
- q) Indicate the elevation of the ground surface, with respect to a permanent benchmark.
- r) Indicate the depth and elevation of the upper boundary of each successive soil strata and at the boring termination depth.
- s) Show a boundary line between the strata and at the boring termination depth.
- t) For each soil strata, describe the soil samples in order of:
 - 1. Relative density or consistency (dense sand or hard clay).
 - 2. Color (Brown, Gray, etc.).
 - 3. Special adjective that is pertinent (varved or organic).
 - 4. Geological origin of soil, if known (loessial or glacial till).

Geotechnical Manual

Chapter 4 Subsurface Explorations and Field Testing

5. Textural classification according to the Illinois Division of Highways triangular diagram, with the main portion in capital letters (silty, sandy CLAY).
 6. Other items of importance; such as, hair cracks, shells, or wood chips should be indicated.
- u) Indicate the SPT blow counts in blows per each 6 in. penetration depth of the split-spoon according to AASHTO T 206 plotted on the vertical scale at the sample depth.
 - v) Indicate the Q_u in tsf, to the nearest 0.1 tsf plotted on the vertical scale at the sample depth. For a bulge type failure, add the letter B; for a shear type failure, add the letter S; for an estimated value, add the letter E; for a pp reading, add the letter P.
 - w) Indicate the moisture content [to the nearest 1% of oven dry mass (weight)] from laboratory analysis plotted on the vertical scale at the sample depth.
 - x) Laboratory classification data can be referred to or included on the Soil Boring Log where appropriate.
 - y) The Soil Boring Log shall also refer to Rock Core Logs where rock coring is performed to continue a soil boring in the same hole.
 - z) For SPT borings, include the SPT hammer average energy transfer ratio (ETR) as a percentage and the drill rig's average blow rate in blows per minute (bpm) as determined by ASTM D 4633 ([Section 4.2](#)).

[Figure 4.4.7.1.2-1](#) shows a typical soil boring log. Form [BBS 137](#) should be used for reporting the final typed boring logs. For reports prepared by consultants, the consultant's name should be placed at the top of the sheet, instead of IDOT's name. A new sheet is required on each hole. For the Soil Boring Log shown in [Figure 4.4.7.1.2-1](#), each major and minor tick mark on the vertical scale is equal to one 6 inch SPT sample interval. The vertical scale allows 20 ft. of depth on each side of the page. If the hole is deeper than 40 ft., the boring should be continued on a second log sheet.

It should be emphasized, that the descriptions and textural classifications for soils entered in a boring log are based on the split-spoon samples, and not on the soil that is augered out of the ground.

Geotechnical Manual

Chapter 4 Subsurface Explorations and Field Testing

 Illinois Department of Transportation <small>Division of Highways Illinois Department of Transportation District 6</small>		SOIL BORING LOG				Page <u>1</u> of <u>2</u>				
ROUTE <u>FAP 91 (IL 16)</u> DESCRIPTION <u>IL 16 over Shoal Creek</u>				LOGGED BY <u>M. Tappan</u>						
SECTION <u>18B-3</u>		LOCATION <u>SE 1/4, SEC. 22, TWP. 10N, RNG. 2W, 3rd PM.</u>								
		<small>Latitude 40°27'4.68", Longitude 90°44'22.2416"</small>								
COUNTY <u>Montgomery</u>		DRILLING METHOD <u>Hollow stem auger, Washed after 25'</u>		HAMMER TYPE <u>Auto SPT Hammer</u>						
STRUCT. NO. <u>068-0502</u> Station <u>420+55.06</u>		D E P T H (ft)	B L O W S (/6")	U C S (tsf)	M O I S T (%)	Surface Water Elev. <u>660.40</u> ft	D E P T H (ft)	B L O W S (/6")	U C S (tsf)	M O I S T (%)
BORING NO. <u>B-2 S.Pier</u> Station <u>437+66</u> Offset <u>5.0 ft left</u> Ground Surface Elev. <u>667.60</u> ft						Stream Bed Elev. <u>657.30</u> ft				
V. Soft Brown and Gray V. Moist SILTY CLAY (fill)						Medium Dense Gray, Dirty, Medium SANDY GRAVEL (continued)				
						Free Water <u>645.30</u>				
Soft Dark Gray, Moist SILTY CLAY						V. Loose Light Gray, Clean, Medium SAND				
Soft Gray, Moist CLAY						V. Loose to Loose Light Gray, Clean, Medium SANDY GRAVEL (Washed)				
Soft Gray, Moist CLAY (till)						(Washed)				
Brown and Gray						Medium Dense Gray, Coarse SANDY GRAVEL				
Loose Gray, V. Moist Dirty Medium SAND						(Washed)				
Gray SHALE Auger refusal @ 629.3 ft.						Borehole continued with rock coring.				

The Unconfined Compressive Strength (UCS) Failure Mode is indicated by (B-Bulge, S-Shear, P-Penetrometer)
 The SPT (N value) is the sum of the last two blow values in each sampling zone (AASHTO T206)

BBS, form 137 (Rev. 8-99)

Figure 4.4.7.1.2-1 Example Soil Boring Log

Geotechnical Manual

Chapter 4 Subsurface Explorations and Field Testing

4.4.7.1.3 Rock Core Logs

Rock Core Logs provide the final typed description of exploration procedures and subsurface conditions encountered during rock coring and pertinent data that will be used during design. IDOT's standard Rock Core Log (form [BBS 138](#)) should be used for all borings involving rock coring. For all structure foundations, and when directed by the DGE, the rock core log shall include laboratory compressive strength data. An example of a properly completed Rock Core Log is shown in [Figure 4.4.7.1.3-1](#). The Rock Core Log shown is a continuation of a Soil Boring Log shown in [Figure 4.4.7.1.2-1](#).

In order to properly complete the standard rock core log, on [Figure 4.4.7.1.3-1](#), the physical properties and arrangement of the rock layers should be fully described on the field boring log. The standard rock core log shall be typewritten and contain the following information, as applicable:

- a) All of the information required in Items a) to l) of [Section 4.4.7.1.2](#).
- b) Indicate the elevation of the ground surface, with respect to a permanent benchmark.
- c) The core barrel type and standard size (BX, NX, etc.).
- d) Core diameter.
- e) Indicate the elevation of the top of rock.
- f) Indicate the elevation of the beginning of coring.
- g) Indicate the depth and elevation of the upper boundary of each successive rock strata and at the core termination depth.
- h) Show a boundary line between the changes in rock strata and at the core termination depth.
- i) For each rock strata, describe the soil samples in order of:
 1. Color (Brown, Gray, etc.).
 2. Rock type.
 3. Moisture condition (wet, damp, dry, etc.).
 4. Grain size and shape (such as, coarse grained, angular or fine grained, rounded).
 5. Texture (stratification/foliation, such as thin-bedded).
 6. Mineral composition (if an experienced geologist is conducting the identification).
 7. Weathering and alteration.

Geotechnical Manual

Chapter 4 Subsurface Explorations and Field Testing

8. Strength (weak or strong – based on experience, otherwise, test rock samples in lab).
9. Other items of importance; such as, hair cracks, shells, or presence of foreign material should be indicated.
- j) Indicate the core number plotted on the vertical scale at the sample depth.
- k) Indicate the core recovery ratio, %, ([Section 4.4.6.2.2](#)) plotted on the vertical scale at the sample depth.
- l) Indicate the rock quality designation (RQD), %, ([Section 4.4.6.2.2](#)) plotted on the vertical scale at the sample depth.
- m) Indicate the average rate of time per foot to complete the core run plotted on the vertical scale at the sample depth.
- n) Indicate the axial compressive strength in tsf ([Section 5.5.12](#)), to the nearest 1 tsf plotted on the vertical scale at the sample depth.
- o) Indicate other laboratory tests such as moisture content [to the nearest 1% of oven dry mass (weight)].

Similar to the Soil Boring Log, the Rock Core Log uses a vertical scale that allows for logging 20 feet of depth in 6 inch increments.

Geotechnical Manual

Chapter 4 Subsurface Explorations and Field Testing



Illinois Department of Transportation
Division of Highways
Illinois Department of Transportation District 6

ROCK CORE LOG

Page 2 of 2
Date 2/6/14

ROUTE FAP 91 (IL 16) DESCRIPTION IL 16 over Shoal Creek LOGGED BY M. Tappan

SECTION 18B-3 LOCATION SE 1/4, SEC. 22, TWP. 10N, RNG. 2W, 3rd PM,
Latitude 40°27'4.68", Longitude 90°44'22.2416"

COUNTY Montgomery CORING METHOD Rotary, Diamond Bit Core Barrel

STRUCT. NO. 068-0502 CORING BARREL TYPE & SIZE NX 5' split barrel

Station 420+55.06

BORING NO. B-2 S. Pier Core Diameter 2 in

Station 437+66 Top of Rock Elev. 630.00 ft

Offset 5.0 ft left Begin Core Elev. 629.30 ft

Ground Surface Elev. 667.60 ft

Description	DEPTH (ft)	CORE (#)	RECOVER (%)	RQD (%)	CORE TIME (min/ft)	STRENGTH (tsf)
Dark Gray SHALE, Damp, Thin Horizontal Lamination, Aphanitic, Highly Weathered, Very Soft Field Hardness	629.30	1	75	0	10	
	-40					
Gray LIMESTONE (4" lens), Dry, Aphanitic, Slightly Weathered, Medium Field Hardness Depth 40.6', Moisture Content: 7.5%, Dry Density: 145.5 pcf	627.30	2	93	93	3	30.0
Dark Gray SHALE, Damp, Thin Horizontal Lamination, Aphanitic, Moderately Weathered, Soft Field Hardness, Occasional Limestone Lenses <2" in Thickness						
Depth 43.6', Moisture Content: 7.4%, Dry Density: 150.9 pcf	-45					94.2
Depth 45.8', Moisture Content: 6.4%, Dry Density: 151.2 pcf		3	100	65	3	74.9
Depth 49.7', Moisture Content: 7.4%, Dry Density: 148.3 pcf	617.30					39.2
Gray LIMESTONE, Damp, Aphanitic, Slightly Weathered, Medium Field Hardness Depth 50.9', Moisture Content: 9.0%, Dry Density: 144.7 pcf	615.80	4	100	65	3	354.8
Dark Gray SHALE, Damp, Thin Horizontal Lamination, Aphanitic, Moderately Weathered, Soft Field Hardness, Occasional Limestone Lenses <2" in Thickness						
Depth 54.3', Moisture Content: 7.3%, Dry Density: 149.2 pcf	-55					113.8
End of Boring	612.30					

Color pictures of the cores Yes

Cores will be stored for examination until Construction is completed.

The "Strength" column represents the uniaxial compressive strength of the core sample (ASTM D-2938)

BBS, form 138 (Rev. 8-99)

Figure 4.4.7.1.3-1 Example Rock Core Log

Geotechnical Manual

Chapter 4 Subsurface Explorations and Field Testing

4.4.7.1.4 Shelby Tube Boring Logs

Logs of Shelby tube borings are reported on the Soil Boring Log form BBS 137. An example of a completed Shelby tube boring is shown in Figure 4.4.7.1.4-1. The log shall be typewritten and contain the following information, as applicable:

- a) All of the information required in Items a) to p) of Section 4.4.7.1.2.
- b) Include a visual identification description of the material visible at the ends of the tubes including textural classification according to the IDH triangular diagram, with the main portion in capital letters (silty, sandy CLAY).
- c) Indicate the tube number and the amount of material recovery for each tube.
- d) For the material visible at the ends of the tubes, indicate the Q_u in tsf, to the nearest 0.1 tsf plotted on the vertical scale at the sample depth. For an estimated value, add the letter E; for a pp reading, add the letter P.

4.4.7.2 Other Records

There are IDOT forms available for documenting the results DCP and SCP tests. These forms are available on-line, and a list is provided below. The applicability of these forms to a given project will be dependent upon the design feature being studied, and types of field tests conducted.

- BMPR SL30: Dynamic Cone Penetration Test
- BMPR SL31: Static Cone Penetration Test

Geotechnical Manual

Chapter 4 Subsurface Explorations and Field Testing



Illinois Department of Transportation
Division of Highways
Illinois Department of Transportation

SOIL BORING LOG

Page 1 of 1
Date 5/1/13

Jerseyville Bypass - Between CH 21 & Witt Mill
Road - Culvert (Shelby Tube)

ROUTE FAP 310 DESCRIPTION Jerseyville Bypass - Between CH 21 & Witt Mill Road - Culvert (Shelby Tube) LOGGED BY CG (KEG)

SECTION 42-4.5 LOCATION SEC. 16, TWP. 8N, RNG. 11W, 3 PM

COUNTY Jersey DRILLING METHOD Continuous ST HAMMER TYPE _____

STRUCT. NO. Station	D E P T H (ft)	B L O W S (/6")	U C S Qu (tsf)	M O I S T (%)	Surface Water Elev.	D E P T H (ft)	B L O W S (/6")	U C S Qu (tsf)	M O I S T (%)
					N/A ft				
BORING NO. <u>C-12-ST</u> Station <u>957+99.52</u> Offset <u>13.00ft Right</u> Ground Surface Elev. <u>563.5</u> ft					Groundwater Elev.:				
					First Encounter <u>553.5</u> ft	▼			
					Upon Completion <u>552.5</u> ft	▽			
					After _____ Hrs. _____ ft				
Dk Br Silty CLAY w/Trace Sand Sample ST 1 Recovery = 24 in (100%) 561.5			0.75 P		Br Clay TILL Sample ST 11 Recovery = 19 in (79%) 541.5				
Dk Br Silty CLAY w/Trace Organics Sample ST 2 Recovery = 24 in (100%) 559.5			0.50 P		Br Mottled Gr Clay TILL Sample ST 12 Recovery = 23 in (96%) 539.5			3.25 P	
Dk Br Silty CLAY w/Trace Pebbles Sample ST 3 Recovery = 23.5 in (98%) 557.5			0.50 P		Gr Mottled Br Clay TILL Sample ST 13 Recovery = 22 in (92%) 537.5			3.00 P	
Gr Br Silty CLAY w/Pebbles Sample ST 4 Recovery = 20.5 in (85%) 555.5			0.75 P		Gr Mottled Br Clay TILL Sample ST 14 Recovery = 24 in (100%) 535.5			1.00 P	
Gr Br Silty CLAY w/Pebbles & Trace Iron Nodules Sample ST 5 Recovery = 21.5 in (90%) 553.5			--		Gr Mottled Br Clay TILL Sample ST 15 Recovery = 24 in (100%) 533.5			2.50 P	
Rd Br Clay TILL w/Pebbles Sample ST 6 Recovery = 22.5 in (94%) 551.5			4.00 P		END OF SHELBY TUBES				
Rd Br Clay TILL Sample ST 7 Recovery = 24 in (100%) 549.5			4.25 P						
Br Clay TIL Sample ST 8 Recovery = 22.5 ft (94%) 547.5			4.5+ P						
Br Clay TILL Sample ST 9 Recovery = 24 in (100%) 545.5			4.25 P						
Br Clay TILL Sample ST 10 Recovery = 24 in (100%) 543.5			3.00 P						

The Unconfined Compressive Strength (UCS) Failure Mode is indicated by (B-Bulge, S-Shear, P-Penetrometer)
The SPT (N value) is the sum of the last two blow values in each sampling zone (AASHTO T206)

BBS, from 137 (Rev. 8-99)

Figure 4.4.7.1.4-1 Example Soil Boring Log Indicating Shelby Tube Sample Locations

Geotechnical Manual

Chapter 4 Subsurface Explorations and Field Testing

4.4.7.3 Electronic Data Submittal

Requirements for electronic submittal of field and laboratory test data vary on a project-by-project basis as directed by the DGE. The forms mentioned in the previous sections are available in Microsoft Word format on the IDOT website <http://www.idot.illinois.gov/> under the “Forms” tab on the **Soils page** (navigational path: [Home > Doing Business > Material Approvals > Soils](#)). The Department also uses gINT software by Bentley Systems, Incorporated for data management and reporting of a geotechnical project’s field and laboratory data. This software is used for development of logs, profiles, graphs, tables, and some forms.

Each District has gINT library and data template files customized for use on IDOT projects. The gINT data template file is used to setup a new project file. The gINT library file controls the formats for logs, profile fences, graphs, and graphic tables, which are used to develop soil boring and rock core logs, create subsurface profiles, and summarize laboratory test results. These items can then be printed or exported into separate documents for incorporation into Geotechnical Reports and plans.

Use of the gINT software is required on a project-by-project basis as directed by the DGE. If gINT is not required, then boring logs and laboratory test results shall be submitted in electronic file and software formats as directed by the DGE.

A project is currently underway to develop a statewide database of boring logs, rock cores, and Shelby tubes historically performed by or for IDOT. Geotechnical consultants may be required to submit a project’s geotechnical field and laboratory data to IDOT in an electronic format which can be imported into IDOT’s gINT database. If gINT is not used, then the data would need to be submitted in a specific format on an Excel spreadsheet.

4.5 (Reserved)

Geotechnical Manual

Chapter 4 Subsurface Explorations and Field Testing

4.6 In Situ Instrumentation for Observations and Monitoring

4.6.1 Groundwater Observation Wells and Piezometers

The groundwater elevation should be observed whenever borings are made, to verify or establish the water table elevation. At some times of the year, water may be encountered even in shallow holes made with augers. The groundwater elevation and site drainage condition should be recorded on the boring log.

When split-spoon or Shelby tube borings are conducted, the groundwater elevation should be observed, at the time of completing the boring and 24 hours later. Unless a granular soil layer is encountered, a subsequent groundwater elevation observation should not be made before 24 hours have elapsed. This is considered to be the time necessary for the water, in most Illinois soils, to reach equilibrium. If the field personnel determine this equilibrium is not reached in 24 hours, additional readings may be necessary. If surface water exists in a nearby stream or ditch, its elevation should also be recorded on the boring log.

The groundwater elevation encountered in a boring may represent a temporary or perched water table. It may also represent the head of water, in some of the more permeable strata at depth. Uniform deposits of fine grained (especially cohesive) soils are practically impermeable, and the water flow through such soils is negligible. Permeability is increased by fissures, and blocky or crumbly soil structure. This structure is caused by frequent wetting and drying, and commonly occurs near the ground surface. Thus, the groundwater elevation in the bore hole may be a function of the piezometric conditions in the more permeable strata. Obviously, if the boring was drilled without the use of water, the groundwater elevation will be related to the permeable strata.

If water has been used in drilling the boring, it should be noted on the field log. Also, some additional information may be desired. Pump or bail out the bore hole and observe the groundwater elevation changes, which occur over a period of time.

Geotechnical Manual

Chapter 4 Subsurface Explorations and Field Testing

To obtain information on the pore water pressures which exist in relatively impermeable strata, special piezometer installations are required. Because of the small amount of water that actually flows through such strata, these installations must be handled with extreme care.

All joints in the piezometer casing must be completely free of leaks. The system must be charged with de-aired water, or water which contains no free air. Isolate the piezometer tip in such a way that it comes to equilibrium with the strata, for which information is desired. This usually requires the packing of bentonite clay balls into the bore hole above and below the piezometer tip, in such a way as to prevent the influence of any extraneous water; which may be supplied from more permeable strata, or from the surface. Since such installations are highly specialized, more detailed procedures are beyond the scope of this manual.

4.6.2 – 4.6.3 (Reserved)

Geotechnical Manual

Chapter 4 Subsurface Explorations and Field Testing

4.7 Construction Inspection Tests

This section discusses the field tests most frequently performed during the course of construction inspection of soils and soil-aggregates.

4.7.1 Field Density and Moisture Measurements

4.7.1.1 One-Point Method and Family of Curves

In lieu of using four moisture density points, some Districts allow evaluation of standard dry density (SDD) and optimum moisture content (OMC) in accordance with Illinois Modified AASHTO T 272, “One-Point Method for Determining Maximum Dry Density and Optimum Moisture” using a family of curves and the one-point method. The one-point method is commonly used in the field for evaluating soils used for embankment construction.

During construction, it is often impractical to perform a complete moisture-density relationship curve for each soil encountered by Illinois Modified AASHTO T 99. This is particularly true for highway construction, because a great number of different soil types may be encountered on an individual project. It would be both time consuming and uneconomical, to establish a moisture-density curve for each new soil type. However, numerical values for the SDD and the OMC of each soil are needed to determine if the soil has been compacted to the specified density and moisture content.

Illinois Modified AASHTO T 272 is a simplified procedure, often referred to as a one-point Proctor, which allows the determination of the SDD and the OMC of a soil. In this procedure, one density and the corresponding moisture content value are determined. These values are typically obtained in a field laboratory, in a relatively short period of time (approximately 20 minutes). The procedure is as follows: A sample of the soil from the field test site is obtained and transported to the field laboratory. This sample must be handled in such a manner as to prevent loss of moisture during transportation. Once in the laboratory, the sample is compacted in a 4 in. (100 mm) diameter mold, according to Illinois Modified AASHTO T 99 (Method C). The mold is struck-off, and the compacted specimen is weighed. The compacted soil sample is then extruded from the mold and placed in an oven or other permissible field drying apparatus for moisture content

Geotechnical Manual

Chapter 4 Subsurface Explorations and Field Testing

determination. Then the dry density and the moisture content of the sample, as compacted, are calculated. With this information, the SSD and the OMC can approximately be estimated by plotting the results on a family of curves as outlined in Illinois Modified AASHTO T 272.

Most Districts have developed a District specific family of curves for soils in their region which can be obtained from the DGE. A family of curves may also be developed for individual projects, which can be very useful for construction projects with a large quantity of earthwork. The procedure for developing a family of curves is provided in Illinois Modified AASHTO R 75, "Developing a Family of Curves".

4.7.1.2 Nuclear Method

The field (in-place) dry density and moisture content of soils and soil-aggregates are determined by the nuclear gauge method according to Illinois Modified AASHTO T 310, "In-Place Density and Moisture Content of Soil and Soil-Aggregate by Nuclear Methods (Shallow Depth)". The field in-place dry density is determined using the direct transmission procedure. In this procedure, the total or wet density is determined by the attenuation of gamma radiation; where a source is placed at a known depth up to 12 in., while the detector remains at the surface. With appropriate gauge calibration and adjustment of data, the wet density is determined. The moisture content of the *in situ* soil is also determined with the nuclear gauge by the thermalization or slowing of fast neutrons, where the neutron source and the thermal neutron detector both remain at the surface (backscatter procedure). The dry density is then computed from the wet density, using [Eq. 5.4\(d\)](#) in [Table 5.4-1](#). A calibration curve must be developed for each nuclear gauge, to correlate the measured intensity of gamma rays with the wet density.

Field density and moisture content are measured in order to conform with the [Standard Specifications](#), where the dry density of embankments, subgrades, or similar construction must be equal to or greater than a specified percentage of the Standard Dry Density (SDD) determined in the laboratory according to Illinois Modified AASHTO T 99 (Method C) or Illinois Modified AASHTO T 272. Depending upon the position within the embankment, different percentages of the SDD are required. The density of the compacted embankment must be checked, by an engineer or a technician, at regular intervals. The field density test is used to verify a contractor's compliance with specifications.

Geotechnical Manual

Chapter 4 Subsurface Explorations and Field Testing

The accuracy of nuclear measurement of moisture contents is susceptible to certain chemical effects. Any organic elements or hydrocarbons; such as, road oil, asphalt, etc., tend to appear as moisture to a gauge, and will result in higher than actual observed moisture content. Chemically-bound water (such as found in gypsum) will also be indicated in nuclear methods, but not in conventional methods. Soils containing iron or iron oxides, having a higher capture cross section, will indicate a lower than actual moisture content. These effects in no way diminish the usefulness of nuclear gauges; as their influence is required to be compensated for by adjustment according to the procedures outlined in Illinois Modified AASHTO T 310.

4.7.1.3 Sand-Cone Method

Another method listed in the [Standard Specifications](#) to obtain the in-place field density of soil and aggregate is the Sand-Cone Method. This test is conducted according to Illinois Modified AASHTO T 191, "Density of Soil In-Place by the Sand-Cone Method". This method is not frequently used in current practice because it takes more time to complete than the nuclear method discussed in [Section 4.7.1.2](#). However, it may be used to verify test results obtained by a nuclear gauge.

4.7.2 Strength Tests

4.7.2.1 Dynamic Cone Penetrometer

The Dynamic Cone Penetrometer (DCP) test is typically used for inspecting subgrades and shallow foundation base materials during construction. The DCP test is performed in accordance with Illinois Test Procedure (ITP) 501 contained in the IDOT *Manual of Test Procedures for Materials* (<http://www.idot.illinois.gov/doing-business/material-approvals/soils/index>, located under the "References" tab, and then under the "Manuals" drop down button). Form [BMPR SL30](#) is available for recording the results.

The DCP was developed by Professor George F. Sowers (1959). ASTM Publication No. STP 399 presents a review of Sowers' work, and data on the correlation between the DCP and the SPT. Some state and local transportation agencies, including IDOT, use the DCP to check the subgrade stability, and depth of subgrade treatment during construction. The DCP currently

Geotechnical Manual

Chapter 4 Subsurface Explorations and Field Testing

used by IDOT slightly differs, in dimensions, from the one developed by Sowers (1959). As shown in [Figure 4.7.2.1-1](#), the DCP consists of:

- a 60-degree cone, with a 0.5 in.² (315 mm²) base area,
- a ±40 in. (±1 m) long, 5/8 in. (16 mm) diameter, graduated steel rod, with 0.2 in. (5 mm) graduations, and
- a 17.6 lb. (8 kg) sliding hammer, which slides along a steel rod to allow for a free fall of 22.6 in. (575 mm). The hammer drops on a drive anvil attached to the rod.

To prepare the equipment for the DCP test, the cone threads into the graduated rod and the rod threads into the drive anvil. The test is conducted by driving the cone into the soil by dropping the hammer onto the drive anvil from a 22.6 in. height and measuring the amount of penetration per blow to determine the penetration rate (PR). The test is continued to a depth of 18 to 36 in. into the soil, as needed. Similar PR values are averaged together, typically in 6 in. increments. The average, indicating the maximum PR, is used for determining the equivalent *in situ* Immediate Bearing Value (IBV). As explained in [Section 8.7](#), the PR is converted to an equivalent IBV value by using [Figure 8.7-1](#). Using the IBV value in [Figure 8.7-2](#), the subgrade stability can be evaluated, to determine the depth of subgrade treatment, if needed.

The [Subgrade Stability Manual](#) can also be referred to for additional information on correlation of DCP test results with soil strength (penetration rate, IBV, and Q_u) and guidance on subgrade treatments.

The DCP is considered to be relatively inexpensive. It requires minimum maintenance, is quick and easy to operate, and allows for frequent field testing at a reasonable pace. The DCP can be driven to a depth of 3 ft. at each test location without excavating any soil layers, and can typically be driven through hard, crusted soils. Also, quite often, silty soils meet the moisture-density requirements, even though the soils could be “pumpy” and unstable under the construction traffic. In such cases, the DCP is a good indicator of subgrade stability.

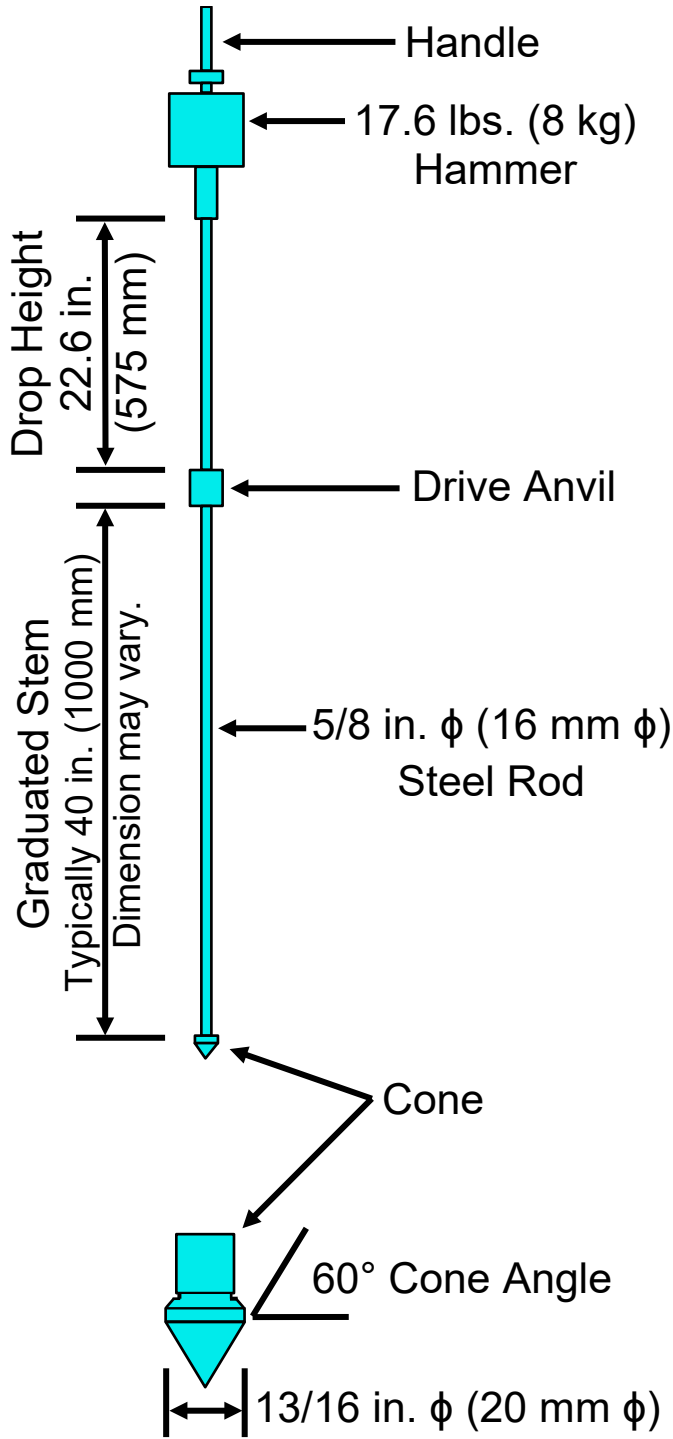

Figure 4.7.2.1-1 The DCP Apparatus

Geotechnical Manual

Chapter 4 Subsurface Explorations and Field Testing

The DCP can also be used to identify soft subgrades in deep cut areas during the subsurface exploration for preliminary estimation of subgrade treatment. In such cases, extension rods may be used to conduct the DCP test a depth of 10 ft. in a soil boring, if a hollow stem auger is used for drilling the boring.

The DCP can be either purchased from a soils testing equipment company, or custom made to specifications using a simple shop drawing ([Figure 4.7.2.1-1](#)).

4.7.2.2 Static Cone Penetrometer

The Static Cone Penetrometer (SCP) test is typically used for inspecting subgrades and shallow foundation base materials during construction. The SCP test is performed in accordance with ITP 502 contained in the IDOT *Manual of Test Procedures for Materials* (<http://www.idot.illinois.gov/doing-business/material-approvals/soils/index>, located under the “References” tab, and then under the “Manuals” drop down button). Form [BMPR SL31](#) is available for recording the results.

The SCP is a static cone penetrometer, which was developed by the Corps of Engineers. It can be used, as an alternative to the DCP, for determining the *in situ* IBV value, and the depth of subgrade treatment during construction. The SCP can also be used during the field exploration, for preliminary estimation of subgrade treatment. The SCP is lighter, and a less awkward tool to use, than the DCP. As shown in [Figure 4.7.2.2-1](#), the SCP consists of:

- a 30-degree cone, with a 315 mm² (0.5 in.²) base area.
- an 18 to 40 in. (0.46 to 1 m) long, graduated steel rod, 5/8 in. (16 mm) diameter, marked at 6 in. (150 mm) intervals. The bottom 6 in. (150 mm) interval is marked at 1 in. (25 mm) subintervals, and
- a proving ring or spring-calibrated dial gauge for measuring the “cone index”.

The cone index is equal to the penetrometer load divided by the base area, and it has units (not expressed) of psi. The SCP test is conducted by pushing the cone slowly into the soil, and the cone index readings are averaged at 6 in. increments of penetration. The lowest average value in the test is then converted into an equivalent IBV, using [Figure 8.7-2](#). In this figure, the cone

Geotechnical Manual
Chapter 4 Subsurface Explorations and Field Testing

index units are in “psi”. The SCP test should be conducted after the subgrade has been stressed with several passes of a loaded truck. Any crust formed on the subgrade, from drying, must be removed before conducting the test. Crusted subgrades give high readings that do not reflect the strength of the weaker underling soil. Several tests should be made to delineate the unstable area in the subgrade. A good judgment is necessary to apply a uniform thickness of improvement over the area, to achieve subgrade stability following [Figure 8.7-2](#).

The [Subgrade Stability Manual](#) can also be referred to for additional information on correlation of SCP test results with soil strength and guidance on subgrade treatments.

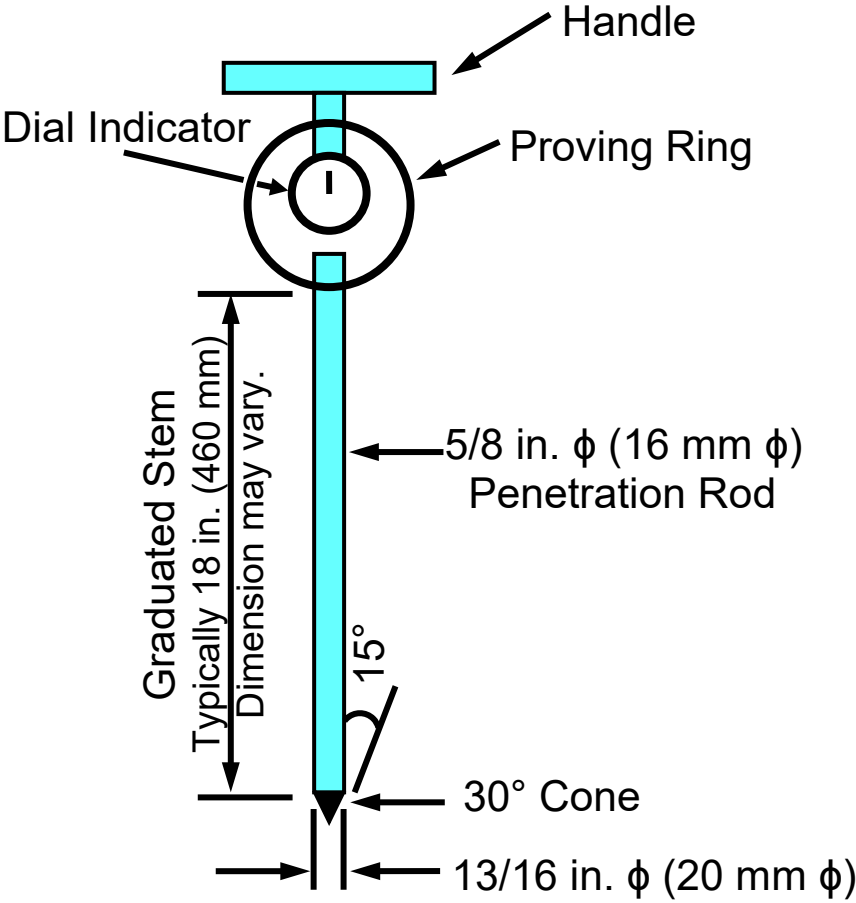

Figure 4.7.2.2-1 The SCP Apparatus

Chapter 5 Laboratory Testing and Soil Mix Designs

5.1 Introduction

This chapter discusses the various laboratory tests performed to determine the physical and engineering properties of soils needed for geotechnical evaluations and analyses. While many laboratory tests for soils have been developed over the years, only those routinely utilized to meet or exceed the minimum requirements of the Department are discussed herein. For detailed descriptions of the test procedures, references are given to applicable AASHTO Standard Method of Tests, Illinois Modified AASHTO Standard Method of Tests, Illinois Laboratory Test Procedures, Illinois Test Procedures, and ASTM Standard Method of Tests. Some of Illinois Modified AASHTO test procedures and Illinois Test Procedures may be found in the *Manual of Test Procedures for Materials* (<http://www.idot.illinois.gov/doing-business/material-approvals/soils/index>, located under the “References” tab, and then under the “Manuals” drop down button) while others may be listed separately on the Department’s website. These can be accessed on the Soils/Geotechnical webpage [Home > Doing Business > Material Approvals > Soils](#) located through selecting:

- “References” tab and the drop-down list “Manuals”
- “Procedures” tabs and the drop-down list “Laboratory/Field Test Procedures”.

5.2 Laboratory Accreditation and Inspection Requirements

The Department is a member of the American Association of State Highway and Transportation Officials’ AASHTO Accreditation Program (AAP) for laboratory testing on construction materials. The AAP is a voluntary program to recognize the competency of a testing laboratory to perform specific tests to national standards and to the highest quality on materials used in the construction and maintenance of highways and bridges. As a member of this program, the Department participates in the AASHTO re:source (formerly AASHTO Materials Reference Laboratory, AMRL) Laboratory Assessment Program (LAP), the AASHTO re:source Proficiency Sample Program (PSP), and the Cement and Concrete Reference Laboratory (CCRL) programs for laboratory inspection and proficiency sample testing.

The AASHTO re:source Laboratory Assessment Program includes quality management system evaluations and on-site assessment of the central laboratories at the CBM. Similar assessments are also performed by CCRL with the central laboratories. The District's Construction Materials Testing Laboratories subsequently receive on-site assessments and proficiency sample testing administered through CBM's central laboratories in accordance with [BMPR Policy Memorandum 21-08.0CBM Policy Memorandum 21-08.3](#), "Minimum Department and Local Agency Laboratory Requirements for Construction Materials Testing or Mix Design".

Consultants contracted to perform Geotechnical Services laboratory testing for the Department must be AASHTO re:source inspected for the tests listed in IDOT's [Description and Minimum Requirements for Prequalification](#) (under the "Prequalification" drop-down tab) for the Geotechnical Services Subsurface Explorations category. The Department also performs on-site assessments of consultant laboratories periodically for performance of the Illinois Modified tests, Illinois Laboratory Test Procedures, and the Illinois Test Procedures. Performance of some specific materials laboratory tests, such as Illinois Modified AASHTO T 288, requires inspection and approval of the consultant laboratory by the CBM in order to be eligible to conduct those tests as outlined in [CBM Policy Memorandum 30-12.2](#).

5.3 Departmental Laboratory Facilities

5.3.1 Central Laboratory Facilities

For geotechnical materials testing, the CBM maintains the Central Soils Laboratory and the Soils Instrumentation Laboratory. These laboratories perform a wide range of materials tests and equipment calibration and repair services for the Districts.

Districts may request soil and rock testing to the Central Soils Laboratory by submitting form BMPR SL19 along with the test samples. However, requests for acceptance sample testing are to be submitted using form BMPR LM6 along with the test samples. Test results are reported back to the Districts. Additionally, test results for acceptance samples are also entered directly into MISTIC (Materials Integrated System for Test Information and Communication) for retrieval by the Districts and other bureaus. When geotechnical engineering analyses are also requested with the laboratory testing, the CBM will issue a summary of the analyses to the Districts along with the test results.

Geotechnical Manual Chapter 5 Laboratory Testing and Mix Designs

The following are tests performed in the CBM Soils Laboratory:

- AASHTO R 58, “Dry Preparation of Disturbed Soil and Soil-Aggregate Samples for Test”
- AASHTO T 11, “Materials Finer Than 75- μm (No. 200) Sieve in Mineral Aggregates by Washing” ([Section 5.5.3](#))
- AASHTO T 27, “Sieve Analysis of Fine and Coarse Aggregate” ([Section 5.5.3](#))
- AASHTO T 88, “Particle Size Analysis of Soils” ([Section 5.5.3](#))
- AASHTO T 89, “Determining the Liquid Limit of Soils” ([Section 5.5.4.1](#))
- AASHTO T 90, “Determining the Plastic Limit and Plasticity Index of Soils” ([Sections 5.5.4.2](#) and [5.5.4.3](#), respectively)
- AASHTO T 99 (Illinois Modified), “Moisture-Density Relations of Soils Using a 5.5-lb Rammer and a 12-inch Drop” ([Section 5.5.14.1](#))
- AASHTO T 100, “Specific Gravity of Soils” ([Section 5.5.2](#))
- AASHTO T 134 (Illinois Modified), “Moisture-Density Relations of Soil-Cement Mixtures”
- AASHTO T 135, “Wetting-and-Drying Test of Compacted Soil-Cement Mixtures”
- AASHTO T 136, “Freezing-and-Thawing Tests of Compacted Soil-Cement Mixtures”
- AASHTO T 146, “Wet Preparation of Disturbed Soil Samples for Test”
- AASHTO T 180 (Illinois Modified), “Moisture-Density Relations of Soils Using a 10-lb Rammer and 18-inch Drop” ([Section 5.5.14.2](#))
- AASHTO T 208, “Unconfined Compressive Strength of Cohesive Soil” ([Section 5.5.10](#))
- AASHTO T 215, “Permeability of Granular Soils (Constant Head)”
- AASHTO T 216, “One-Dimensional Consolidation Properties of Soils” ([Section 5.5.13.1](#))
- AASHTO T 265 (Illinois Modified), “Laboratory Determination of Moisture Content of Soils” ([Section 5.5.1](#))
- AASHTO T 288 (Illinois Modified), “Determining Minimum Laboratory Soil Resistivity” ([Section 5.5.7.1](#))
- AASHTO T 296, “Unconsolidated, Undrained Compressive Strength of Cohesive Soils in Triaxial Compression” ([Section 5.5.9.1](#))
- AASHTO T 297, “Consolidated, Undrained Triaxial Compression Test on Cohesive Soils” ([Section 5.5.9.2](#))

Geotechnical Manual Chapter 5 Laboratory Testing and Mix Designs

- ASTM D 4253, "Standard Test Methods for Maximum Index Density and Unit Weight of Soils Using a Vibratory Table" ([Section 5.5.15](#))
- ASTM D 4254, "Standard Test Methods for Minimum Index Density and Unit Weight of Soils and Calculation of Relative Density" ([Section 5.5.15](#))
- ASTM D 7012, "Compressive Strength and Elastic Moduli of Intact Rock Core Specimens under Varying States of Stress and Temperatures" ([Section 5.5.12](#))
- Illinois Bearing Ratio ([Section 5.5.16](#))
- Immediate Bearing Value ([Section 5.5.17](#))
- Soil Modification Mixtures ([Section 5.6.1](#))
- Soil Stabilization Mixtures ([Section 5.6.2](#))
- Erosion Function Apparatus (Pier Scour Testing & Analysis)

The following tests are coordinated by the Soils Laboratory but performed in the Analytical Chemical Laboratory:

- Topsoils:
 - AASHTO T 194, "Determination of Organic Matter in Soils by Wet Combustion" ([Section 5.5.6.1](#))
 - ASTM D 4972, "pH of Soils" ([Section 5.5.8](#))
- Peat Materials:
 - AASHTO T 267, "Determination of Organic Content in Soils by Loss of Ignition" ([Section 5.5.6.2](#))
- Hydrated Lime, Quicklime, By-Product Limes:
 - ASTM C 25, "Chemical Analyses of Limestone, Quicklime, and Hydrated Lime"
- MSE Wall Materials:
 - AASHTO T 267 (Illinois Modified), "Determination of Organic content in Soils by Loss on Ignition" ([Section 5.5.6.2](#))

Geotechnical Manual Chapter 5 Laboratory Testing and Mix Designs

- AASHTO T 289 (Illinois Modified), “Determining pH of Soil for Use in Corrosion Testing” ([Section 5.5.7.2](#))
- AASHTO T 290 (Illinois Modified), “Determining Water-Soluble Sulfate Ion Content in Soil” ([Section 5.5.7.3](#))
- AASHTO T 291 (Illinois Modified), “Determining Water-Soluble Chloride Ion Content in Soil” ([Section 5.5.7.3](#))

- Fly Ash (used in soil modification):
 - AASHTO M 295, “Coal Fly Ash and Raw or Calcined Natural Pozzolan for Use in Concrete”
 - ITP 27, “Sieve Analysis of Fine and Coarse Aggregate”

The following tests are performed by the Cement Laboratory and/or Analytical Chemical Laboratory:

- Cement (used in soil modification, stabilization, and pozzolanic mixtures):
 - AASHTO T 105, “Chemical Analysis of Hydraulic Cement”
 - AASHTO T 106, “Compressive Strength of Hydraulic Cement Mortar (Using 2-inch Cube specimens)”
 - AASHTO T 107, “Autoclave Expansion of Hydraulic Cement”
 - AASHTO T 129, “Amount of Water Required for Normal Consistency of Hydraulic Cement Paste”
 - AASHTO T 131, “Time of Setting of Hydraulic Cement by Vicat Needle”
 - AASHTO T 133, “Density of Hydraulic Cement”
 - AASHTO T 137, “Air Content of Hydraulic Cement Mortar”
 - AASHTO T 153, “Fineness of Hydraulic Cement by Air Permeability Apparatus”
 - AASHTO T 154, “Time of Setting of Hydraulic Cement Paste by Gillmore Needles”
 - AASHTO T 186, “Early Stiffening of Hydraulic Cement (Paste Method)”
 - AASHTO T 192, “Fineness of Hydraulic Cement by the No. 325 Sieve”
 - ASTM C 1038, “Expansion of Hydraulic Cement Mortar Bars Stored in Water”

Geotechnical Manual Chapter 5 Laboratory Testing and Mix Designs

- Concrete Subjected to Sulfate Attack in Soil or Groundwater:
 - AASHTO T 290, “Determining Water-Soluble Sulfate Ion content in Soil”
 - ASTM D 516, “Sulfate Ion in Water”

The Soils Laboratory also provides calibration verification and limited repair services for Department owned Rimacs for the Districts.

The CBM Soils Instrumentation Laboratory offers the following calibration and repair services to the Districts.

- Calibration Services:
 - AASHTO T 287 (Illinois Modified), “Asphalt Binder Content of Asphalt Mixtures by the Nuclear Method”
 - AASHTO T 310 (Illinois Modified), “In-Place Density and Moisture Content of Soil and Soil-Aggregate by Nuclear Methods (Shallow Depth)” ([Section 4.7.1.2](#))
- Repair Services:
 - Asphalt Content Gauge
 - Nuclear Gauge
 - Slope Inclinator
 - Earth Resistivity

5.3.2 District Laboratory Facilities

Each District has a main Construction Materials Testing Laboratory and may have one or more satellite and field laboratories. [CBM Policy Memorandum 21-08.3](#), “Minimum Department and Local Agency Laboratory Requirements for Construction Materials Testing or Mix Design” lists the tests that each District’s main laboratory is required to perform and several optional tests. The optional tests performed by the District laboratories vary depending upon the capability of the laboratory.

5.4 Mass, Weight and Volume Relationships

Various laboratory tests are used to determine index properties and other physical characteristics of soils and aggregate-soils materials for use in analyses, design, and construction of highway projects. Many soil properties vary as the mass, or weight, and volume relationship of a soil changes. The mass, or weight, and volume relationships are a basic component of many of the laboratory test procedures and engineering analyses. Common formulas used to determine mass, or weight, and volume relationships of soil masses are shown in [Table 5.4-1](#) and illustrated in [Figure 5.4-1](#).

Soil consists of solid particles and void spaces that, generally, consist of air and water, as illustrated by the phase diagram in [Figure 5.4-1\(a\)](#). Soil in this condition is called partially saturated. If the void spaces are completely filled with water, the soil is saturated and consists of two components, solids and water, as shown in [Figure 5.4-1\(b\)](#). It is not physically possible to separate the various components as shown in the diagrams; however, the concept illustrated provides the basis for computing various soil properties. Note that M for mass is used for simplicity in the phase diagrams in [Figure 5.4-1](#), but it can be replaced with W for weight if the unit weight is to be used instead of density.

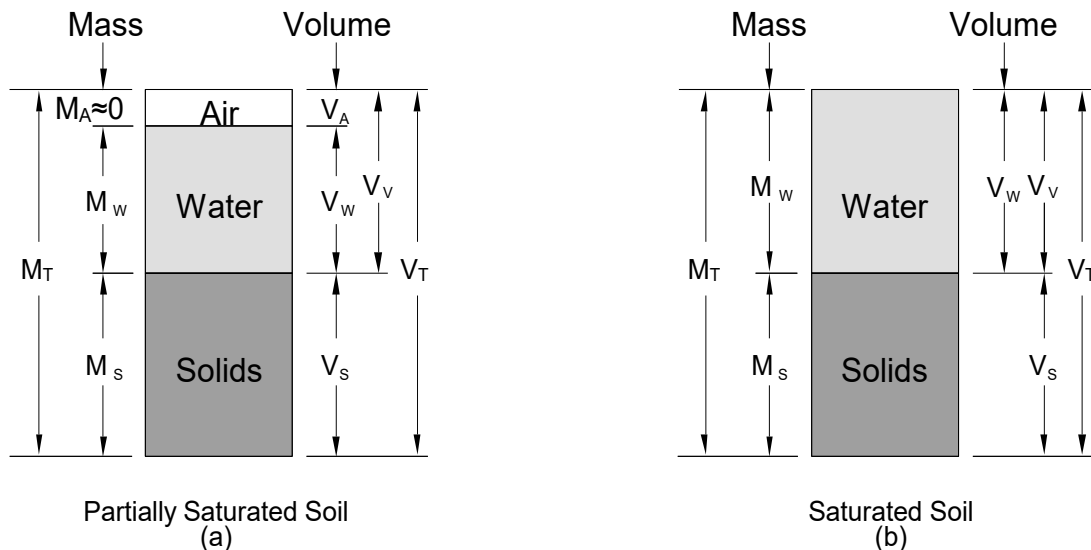

Figure 5.4-1 Phase Diagram for a Soil Mass

[Table 5.4-1](#) gives the formulas which define the fundamental soil mass, or weight, and volume relationships. These relationships can be determined from the formulas in [Table 5.4-1](#) and the phase diagrams in [Figure 5.4-1](#) with a few measurements and tests on soil samples. The moisture content is most commonly determined by testing. The specific gravity of solids is also determined by testing or calculation; however, it is often assumed that 2.65 is a typical value for sands, and 2.70 is typical for clays. The other mass-volumetric relationships can then be derived from mass, or weight, and volumetric measurements of the soils samples and applying the moisture content and specific gravity values of those samples.

Density and unit weight are terms commonly used interchangeably in geotechnical engineering, particularly when working in English units. Density (ρ), expressed in pound-mass per cubic foot (pcf) [or kg/m^3], is the mass (M) per unit of total soil volume (V_T). Density (ρ) is most often used in earthwork quantity estimations and field inspections for compaction of subgrades and embankments. The unit weight (γ), expressed in pound-force per cubic foot (pcf) [or kN/m^3], is the weight (W), as a gravitational force, divided by V_T . The unit weight (γ) is most often used in geotechnical analyses; such as, slope stability, lateral earth pressure, pile capacity, soil shear strength, and any analysis in which the gravitational force or weight of soil is required. In this chapter, reference is made to density; however, proper conversion should be performed if the unit weight is to be used.

Property	Formula	Equation No.
Moisture Content, w	$w (\%) = \frac{M_W}{M_S} \times 100 = \frac{W_W}{W_S} \times 100$	5.4(a)
Wet (Total) Density, ρ	$\rho = \frac{M_T}{V_T}$	5.4(b)
Wet (Total) Unit Weight, γ_{wet}	$\gamma_{wet} = \frac{W_T}{V_T}$	5.4(c)
Dry Density, ρ_d (where w is not a percentage)	$\rho_d = \frac{M_S}{V_T} = \frac{\rho}{1 + w}$	5.4(d)
Dry Unit Weight, γ_d (where w is not a percentage)	$\gamma_d = \frac{W_S}{V_T} = \frac{\gamma_{wet}}{1 + w}$	5.4(e)
Void Ratio, e	$e = \frac{V_V}{V_S}$	5.4(f)
Porosity, n	$n (\%) = \frac{V_V}{V_T} = \frac{e}{1 + e}$	5.4(g)
Degree of Saturation, S	$S (\%) = \frac{V_W}{V_V} \times 100$	5.4(h)
Specific Gravity, G_s	$G_s = \frac{\gamma_s}{\gamma_w} = \frac{\rho_s}{\rho_w} = \frac{M_s/V_s}{\rho_w}$	5.4(i)

Where:

V_s , V_w , and V_a = volume of solids, water, and air, respectively

V_v = volume of voids ($V_w + V_a$)

V_T = total volume of solids, water, and air ($V_s + V_w + V_a$)

W_s , W_w , and W_a = weight of solids, water, and air, respectively

W_T = total weight of solids and water ($W_s + W_w$)

M_s , M_w , and M_a = mass of solids, water, and air, respectively

M_T = total mass of solids and water ($M_s + M_w$)

γ_s and ρ_s = unit weight of solids and density of solids, respectively

γ_w = unit weight of water = 62.4 lb/ft³ (9.81 kN/m³)

ρ_w = density of water = 62.4 lbf/ft³ (1,000 kg/m³)

$W = M \times g$, where g = gravitational acceleration = 32.2 ft/s² (9.81 m/s²)

(Note: 1 lb. force = 1 lbf X 32.2 ft/s², 1 N = 1 kg·m/s²)

Table 5.4-1 Soil Mass and Volumetric Relationships

5.5 Laboratory Tests

5.5.1 Moisture Content

Moisture content determination is one of the most frequently performed tests on soils because a soil's strength and behavior can significantly vary over a range of moisture contents. The moisture content of a soil mass is also used in calculations for many other tests to determine soil properties such as unit weight, shear strength, permeability, compressibility, Atterberg Limits, moisture-density relationships, and other properties.

The moisture content of a soil is defined as the ratio of the mass of water in a specimen to the oven-dry mass of the specimen's soil solids, and it is normally reported as a percentage. It is determined by testing according to Illinois Modified AASHTO T 265, "Laboratory Determination of Moisture Content of Soils", and the basic formula defining the moisture content is shown in Equation 5.4(a) of [Table 5.4-1](#).

5.5.2 Specific Gravity

Specific gravity is the ratio of the mass of a given volume of a material at a stated temperature to the mass of the same volume of gas-free distilled water at the same temperature. It is used in the mass/weight-volumetric relationship calculations for several other soil test methods.

The "Specific Gravity of Soils" is determined by testing according to AASHTO T 100. However, this test method directs the user to determine the specific gravity of particles larger than 4.75-mm (No. 4) sieve according to AASHTO T 85, "Specific Gravity and Absorption of Coarse Aggregate". Then, when a soil is composed of particles both larger and smaller than the 4.75-mm (No. 4) sieve, a weighted average specific gravity is calculated from the percentages of particles retained and passing the 4.75-mm (No. 4) sieve. AASHTO T 100 additionally notes that the specific gravity of soils to be used in connection with the hydrometer portion of AASHTO T 88 is intended to be that portion passing the 2.00-mm (No. 10) sieve.

Typically, the range of specific gravity for soils is between 2.60 and 2.85. In Illinois, most soils will have specific gravities ranging between 2.62 and 2.75. However, soils with measurable organic contents or porous particles, such as expanded slag, may have much lower specific gravities. Soils containing an appreciable quantity of heavy minerals, such as iron, may have much higher specific gravity values.

5.5.3 Particle Size Analysis

Particle size analyses are commonly referred to as “grain size analyses”. They are used for soil classification, correlation with soil permeability, design of filters and drainage systems, identification of frost-susceptible soils, and for approximate assessment of soil strength.

A particle size analysis is a quantitative determination of the distribution of particle sizes present in a soil sample. The procedure is accomplished by means of sieve and hydrometer analyses. The sieve analysis provides the percentage of sand and gravel, but it cannot distinguish between the percentages of silt and clay sized particles. The hydrometer test is then used to determine the percentages of silt and clay in a soil.

The sieve analysis portion of the test is conducted according to AASHTO T 27, “Sieve Analysis of Fine and Coarse Aggregates” and AASHTO T 11, “Materials Finer than 75- μm (No. 200) Sieve in Mineral Aggregates by Washing”. In the AASHTO T 27 sieve analysis, the soil specimen is shaken through a stack of wire-cloth sieves which decrease in standard sized openings from top to bottom within the stack. By this means of testing, the definition of particle diameter in a sieve analysis is the side dimension of a square hole. The lower limit of the sieve opening size is 0.075 mm (No. 200 sieve) for this test method. Test method AASHTO T 11 is then used for an accurate determination of material finer than the 0.075 mm (No. 200 sieve) by washing.

To determine the percentages of silt and clay sized materials passing the 0.075 mm (No. 200) sieve, a hydrometer analysis is performed. This test is conducted according to AASHTO T 88, “Particle Size Analysis of Soils”. The hydrometer method is based upon Stokes' equation for the velocity of freely falling spheres. By this means of testing, the definition of a particle diameter in a hydrometer test is the diameter of a sphere of the same density which falls at the same velocity as the particle in question.

The results of both sieve and hydrometer analyses for a soil are reported graphically on a combined particle size distribution curve and/or summarized in a table. For various reasons, the

curve is only approximate. The accuracy of particle size distribution curves for fine grained soils is more questionable than the accuracy of the curves for coarser soils. This is because fine grained soils particles look like platelets but are assumed spherical in Stoke's Law in the hydrometer analysis.

5.5.4 Atterberg Limits and Plasticity Index

A fine grained soil can exist in several of several states of consistency. The state of consistency and the behavior of any particular soil depend primarily upon the amount of water present in the soil-water composition. In 1911, A. Atterberg defined the boundaries several states of consistency in terms of moisture content limits. These limits are commonly called the Atterberg Limits. The limits which are most commonly used in geotechnical engineering are the liquid limit (LL), plastic limit (PL), and shrinkage limit (SL). These limits and the zones between them are illustrated in [Figure 5.5.4-1](#).

These Atterberg limits provide general indices of moisture content beyond which the soil changes from one consistency state to another. These limits are used for soil classification. They are also useful for correlating soil behavior such as compressibility, permeability, shrinkage and swelling, liquefaction susceptibility, and strength.

5.5.4.1 Liquid Limit

The liquid limit of a soil is arbitrarily defined as the moisture content at which a soil transitions from a plastic state to a liquid state. It is determined by testing according to AASHTO T 89, "Determining the Liquid Limit of Soils". This test method establishes the liquid limit as the moisture content of a soil when a standard-sized groove cut into a soil sample placed in a standardized brass cup closes upon dropping the cup 25 times from a 0.394 in. (10 mm) height.

5.5.4.2 Plastic Limit

The plastic limit of a soil is generally defined as the moisture content at which a soil transitions from a semi-solid state to a plastic state. It is determined by testing according to AASHTO T 90, "Determining the Plastic Limit and Plasticity Index of Soils". The plastic limit is determined in this test method by measuring the moisture content at which a soil begins to crumble when rolled into a 1/8 in. (3 mm) diameter thread.

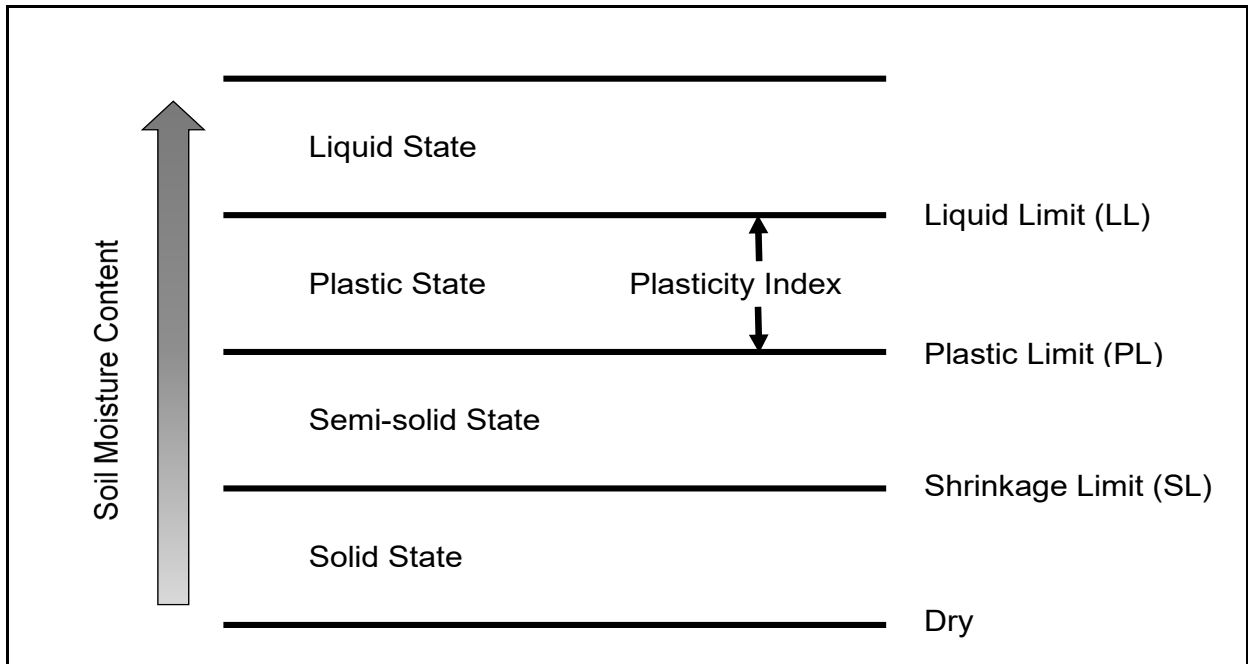

Figure 5.5.4-1 Schematic showing Atterberg Limits and Corresponding Physical States of Soil in the Remolded Condition versus Moisture Content

5.5.4.3 Plasticity Index

The plasticity index (PI) is also determined according to AASTHO T 90, and it represents the range of moisture content through which the soil is in the plastic state. This is the moisture content range between the plastic limit and liquid limit, which is simply the moisture content at the liquid limit minus the moisture content at the plastic limit ($PI = LL - PL$). The plasticity index is commonly referred to as the "PI", and it is an index property which is used in both soil classification and correlating to soil behavior.

5.5.4.4 Shrinkage Limit

The shrinkage limit is rarely used by the Department; however, it can be useful in predicting the maximum loss of volume of a soil. As soil dries to the shrinkage limit, there is a loss of volume with the loss of water. Further drying below the shrinkage limit removes water only without corresponding volume loss. This limit may be useful in evaluating the lower limit volume change an embankment material may undergo when removed from a wet borrow, and subsequently dried and rolled into a fill. Laboratory determination of the shrinkage limit was formerly performed according to AASHTO T 92. This test method required the use of liquid mercury, and it has been withdrawn by AASHTO. The replacement laboratory test method is ASTM D 4943, "Standard

Test Method for Shrinkage Factors of Soils by the Wax Method”. The shrinkage limit is determined in this test method by drying a saturated soil and measuring the limiting moisture content at which no further volume changes occur with loss of water.

5.5.5 Soil Classification

The Department utilizes two classification systems for soils. The first is the Illinois Division of Highways (IDH) Textural Classification System. The second is the AASHTO system according to AASHTO M 145, “Standard Specification for Classification of Soil and Soil-Aggregate Mixtures for Highway Construction Purposes”. Both systems apply to material passing the 3 in (75 mm) sieve.

Typically, soil samples are initially assessed in the field using visual-manual identification procedures which approximately describe the soil as to texture, color, odor, particle size, plasticity, structure, moisture, and density as discussed in [Section 4.4.6.1.1](#). Then, laboratory testing is used to classify the soils and subsequently verify or correct the field descriptions. After laboratory classifications, the Group symbols (i.e., A-4(6), A-7-6(21)) are assigned on the boring logs for only the soil samples tested for classification.

5.5.5.1 Illinois Division of Highways Textural Classification

The IDH Textural Classification System is used to describe soils for the Department’s highway projects. The soil descriptions are based on the range and percentages of particle size within the soil matrix. Grain size distributions obtained from sieve and hydrometer analyses are used with [Figure 5.5.5.1-1](#) to classify the soil according to the Illinois Division of Highways (IDH) Classification Chart. The particle size limits for the various ranges soil constituents correspond with those in AASHTO M 146, “Terms Relating to Subgrade, Soil-Aggregate, and Fill Materials”, which are summarized in [Table 5.5.5.1-1](#). Note that the IDH diagram should not be confused with the USDA/NRCS textural classification diagram of [Figure A.5.1-1](#), discussed in Appendix A.

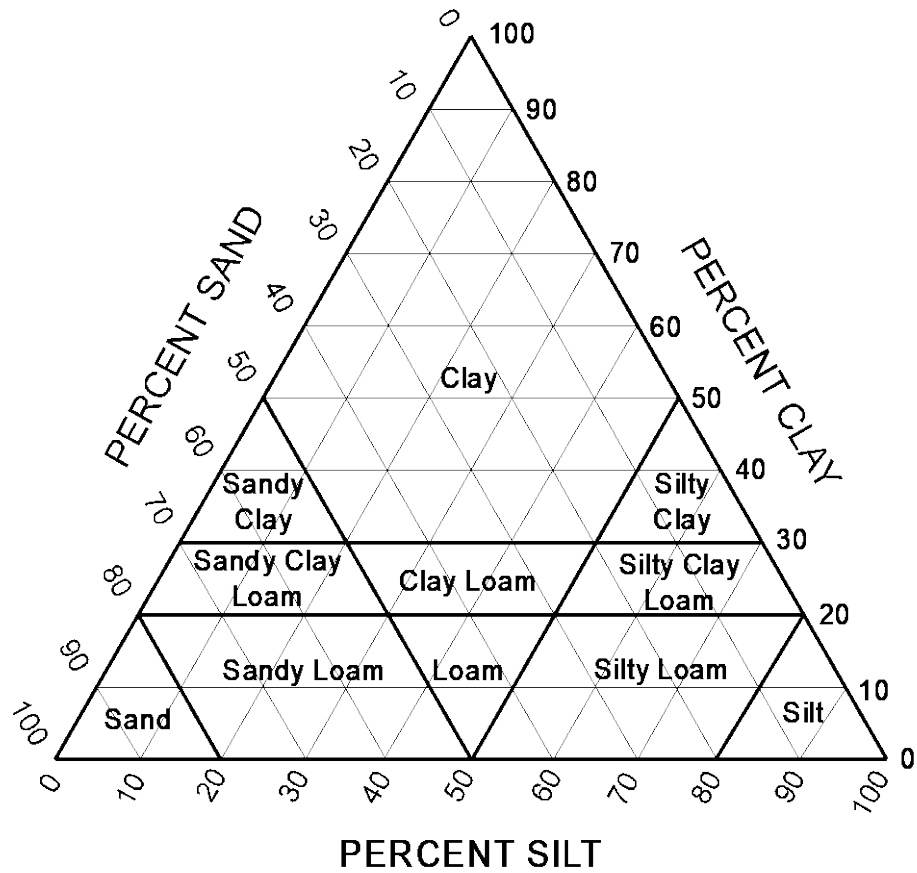

SIZE LIMITS		
SAND: 2.0 to 0.075 mm	SILT: 0.075 to 0.002 mm	CLAY: Below 0.002 mm

Figure 5.5.5.1-1 IDH Textural Classification Chart

Description		Size Range	
		mm	U.S. Sieve
Boulder ^a		> 305	> 12 in.
Cobble		305 to 75	12 in. to 3 in.
Gravel	Coarse	75 to 25	3 in. to 1 in.
	Medium	25 to 9.5	1 in. to 3/8 in.
	Fine	9.5 to 2.00	3/8 in. to No. 10
Sand	Coarse	2.00 to 0.425	No. 10 to No. 40
	Fine	0.425 to 0.075	No. 40 to No. 200
Silt		0.075 to 0.002	< No. 200
Clay		< 0.002	-
^a See the applicable sections of the Standard Specifications for minimum boulder sizes eligible for payment, such as 1/2 cubic yard (0.5 cubic meter) for rock excavation in Article 202.07(b) and Article 502.03.			

Table 5.5.5.1-1 IDH Particle Size Limits of Soil Constituents defined in AASHTO M 146

5.5.5.2 AASHTO M 145 Classification

The AASHTO Soil Classification System is used in conjunction with the IDH System for description of soil on roadway projects. This classification system is outlined in AASHTO M 145, “Standard Specification for Classification of Soils and Soil-Aggregate Mixtures for Highway Construction Purposes”. It uses the results of particle size analyses, liquid limit and plasticity index testing to classify soils.

The AASHTO Soil Classification System categorizes the soils into seven major groups (A-1 to A-7) and several subgroups (A-1-a, A-1-b, A-2-4, A-2-5, A-2-6, A-2-7, A-7-5, and A-7-6). This soil classification system is based on observed field performance of subgrade soils under highway pavements. Soils having approximately the same general load carrying capacity and service characteristics are grouped together. In general, the best soils for highway subgrades are classified as A-1, the next best A-2, and the poorest subgrade soils are classified as A-7. Highly organic soils, such as peat and muck, may also be classified as group A-8. Soils in the A-8 group are considered unsuitable for use in embankments and subgrades as they are highly compressible and have low strength.

[Table 5.5.5.2-1 \(a\) and \(b\)](#) summarizes the AASHTO soil classification system. To classify soils, proceed from left to right on Table 5.5.4.2-2 (a) or (b). The correct group is found by the process of elimination, and it is the first group from the left into which the test data will fit. Then, the AASHTO classification is further refined by the calculating the group index (GI) which is shown in parentheses () after the group symbol. For example, A-2-6(3) or A-7-6(17) are group symbols followed by the GI. As discussed in AASHTO M 145, the subgrade supporting value decreases as the group index increases. For example, GI = 0 indicates a “good” subgrade material, and GI = 20 or greater indicates a “very poor” subgrade material. The group index is calculated from the following formula:

$$\text{Group index} = (F - 35) [0.2 + 0.005 (LL - 40)] + 0.01 (F - 15) (PI - 10) \quad (\text{Eq. 5.5.5.2-1})$$

Where:

F = Percentage passing the No. 200 (0.075 mm) sieve, expressed as a whole number.

This percentage is based only on the material passing the 3 in. (75 mm) sieve.

LL = liquid limit, and

PI = plasticity index.

Group indexes are reported as whole numbers. A negative GI is reported as zero. Additionally, only the PI portion of the group index formula is used to calculate the group index for the subgroups A-2-6 and A-2-7.

Table 5.5.5.2-1(a)

General Classification	Granular Materials [35 Percent or Less Passing No. 200 (0.075 mm)]			Silt-Clay Materials [More than 35 Percent Passing No. 200 (0.075 mm)]			Highly Organic soils
	A-1	A-3 ^a	A-2	A-4	A-5	A-6	
Sieve analysis, percent passing:							
No. 10 (2.00 mm)	-	-	-	-	-	-	-
No. 40 (0.425 mm)	50 max	51 min	-	-	-	-	-
No. 200 (0.075 mm)	25 max	10 max	35 max	36 min	36 min	36 min	36 min
Characteristics of fraction passing No. 40 (0.425 mm):							
Liquid Limit	-	-	See Table 5.2.2-2(b) below for values.	40 max	41 min	40 max	41 min
Plasticity Index	6 max	NP ^b		10 max	10 max	11 min	11 min
General Rating as Subgrade							

^a The placing of A-3 before A-2 is necessary in the “left to right elimination process” and does not indicate superiority of A-3 over A-2.
^b NP = Nonplastic

Table 5.5.5.2-1(b)

General Classification	Granular Materials [35 Percent or Less Passing No. 200 (0.075 mm)]						Silt-Clay Materials [More than 35 Percent Passing No. 200 (0.075 mm)]			Highly Organic soils	
	A-1		A-3	A-2			A-4	A-5	A-6		A-7
Group Classification	A-1-a	A-1-b		A-2-4	A-2-5	A-2-6	A-2-7			A-7-5, A-7-6	
Sieve analysis, percent passing:											
No. 10 (2.00 mm)	50 max	-	-	-	-	-	-	-	-	-	-
No. 40 (0.425 mm)	30 max	50 max	51 min	-	-	-	-	-	-	-	-
No. 200 (0.075 mm)	15 max	25 max	10 max	35 max	35 max	35 max	35 max	36 min	36 min	36 min	36 min
Characteristics of fraction passing No. 40 (0.425 mm):											
Liquid Limit	-	-	-	40 max	41 min	40 max	41 min	40 max	40 max	41 min	41 min
Plasticity Index	6 max	NP	NP	10 max	10 max	11 min	11 min	10 max	11 min	11 min	11 min ^a
Usual types of significant constituent materials	Stone fragments, gravel and sand			Silty or clayey gravel and sand			Silty soils			Clayey soils	
General Rating as Subgrade	Excellent to Good						Fair to Poor				

^a Plasticity index of A-7-5 subgroup is equal to or less than LL – 30. Plasticity index of A-7-6 subgroup is greater than LL – 30.

Table 5.5.5.2-1 AASHTO Classification of Soils and Soil-Aggregate Mixtures, AASHTO M 145

5.5.6 Organic Content

Organic material is desirable in soil for landscaping purposes, but very undesirable in a foundation soil. Organic soils are usually identified by their dark color (dark gray, dark brown, or black) and their somewhat musty, decayed odor. It is, usually, possible to visually identify small vegetable, root, or leaf particles present in organic soils. An extreme example of a highly organic soil would be: a peat deposit, which is composed of nearly 100% organic material, and exhibits very high compressibility.

For highway construction purposes, the organic content of a soil is important, primarily, for three reasons:

1. Some organic matter is necessary to support plant growth along the roadway, for erosion control and aesthetic appearances.
2. Excessive amounts of organic material in a foundation soil, or in a compacted fill has low strength and will tend to decay with time, creating voids or chemical alteration of soils, resulting in possible detrimental settlement and possible foundation soil instability.
3. Significant amounts of finely divided organic particles often affect the index properties of a soil, such as the Atterberg Limits, by an amount sufficient to change the soil classification.

5.5.6.1 Wet Combustion Test

The Department primarily specifies AASHTO T 194, "Determination of Organic Matter in Soils by Wet Combustion" for organic content testing in soils. Examples of [Standard Specifications](#) calling for AASHTO T 194 test method include topsoil and Borrow and Furnished Excavation soils obtained from off of the right-of-way. The "Wet Combustion" test method measures the amount of potassium dichromate reduced by the organic matter present. This value is then converted into percent of carbon oxidized; and finally, to the total amount of organic matter by computation. The "Wet Combustion" test method is most reliable for the determination of humus-like, easily oxidized organic matter.

When fresh (undecayed) plant roots, wood, fresh grass, weeds, etc., or when hydrocarbons, charcoal, lignite, coal, and organic remains in ancient sediments are present, the reagents used in the “wet combustion” test do not react well, and the results may be lower than the actual total organic matter present. If such materials are present and the total organic content is to be determined, then the Loss on Ignition method (AASHTO T 267) shall be used.

5.5.6.2 Loss on Ignition Test

The test method AASHTO T 267, “Determination of Organic Content in Soils by Loss on Ignition” is a “dry combustion” method, where all carbon is burned and measured as weight of carbon dioxide lost. This test method is most applicable to materials identified as peats, organic mucks, and soils containing relatively undecayed vegetative matter of fresh plant materials or carbonaceous materials such as lignite, coal, etc. However, this method may error on the high side due to the breakdown of certain soil minerals and the evaporation of hydrated water at high temperatures.

Note that if fill material is to be tested for Mechanically Stabilized Earth (MSE) Retaining Walls, Illinois Modified AASHTO T 267 is specified in the [Standard Specifications](#).

5.5.7 Soil Corrosive Potential Tests

It is common for metal elements to be installed in soils or aggregates for highway construction applications. Examples include piles, pipes, anchors, sheet piling, and MSE retaining wall soil reinforcement. Some soil conditions may accentuate the corrosion of metals and impact the durability of geosynthetic materials. A series of electrochemical tests can be performed to assess the corrosive potential of soils. These tests include resistivity, pH, sulfate ion content, and chloride ion content.

The Department most frequently performs these electrochemical tests on MSE retaining wall select fill material. Other applications depend on the type of structure, environmental conditions, and level of design risk. The Districts should consult with the bureau of Bridges and Structures’ Foundations & Geotechnical Unit or with the Central Bureau of Material’s Soils and Concrete Unit for guidance on use of these tests for elements other than MSE retaining wall backfill.

Permissible ranges or concentrations of the soil electrochemical properties depend on the structural element material, design life, and other environmental influences such as groundwater. When applicable, the permissible electrochemical levels must be included in plan specifications or special provisions for material acceptance.

5.5.7.1 Resistivity

Resistivity is the measure of a material's opposition to the flow of electric current. The lower a material's resistivity value indicates that it more readily allows for the flow of electrical current. The resistivity test can provide an indirect measurement of soluble salt content. Determining the minimum laboratory resistivity of a soil is one measure used to evaluate soil conditions which may accentuate the corrosion of metals.

The test method for "Determining Minimum Laboratory Soil Resistivity" is performed in accordance with AASHTO T 288 or with Illinois Modified AASHTO T 288, when call for by plan special provision. This test method uses a resistivity meter to measure the resistance of a soil or soil-aggregate sample placed between two electrodes in a soil box. Several measurements are taken of the material across a range of moisture contents to determine the minimum resistivity value.

5.5.7.2 pH Value

pH of Soil for Use in Corrosion Testing" is performed in accordance with AASHTO T 289 or with Illinois Modified AASHTO T 289, when call for by plan special provision. With this test method, the pH of a soil (soil-water solution) is determined directly from a pH meter. The pH meter measures the voltage with one or two electrodes inserted in a soil-water solution. By comparing the voltage reading obtained with the readings on standardized solutions of known pH, the pH of the soil-water solution is then determined.

5.5.7.3 Sulfate and Chloride Ion Content

Most soluble salts are active participants in the corrosion process with sulfates and chlorides being chief agents. The test method for "Determining Water-Soluble Sulfate Ion Content in Soil" is performed in accordance with AASHTO T 290 or with Illinois Modified AASHTO T 290, when call for by plan special provision. Subsequently, the test method for "Determining Water-Soluble

Chloride Ion Content in Soil” is performed in accordance with AASHTO T 291 or with Illinois Modified AASHTO T 291, when call for by plan special provision. The maximum concentrations allowed in a soil or aggregate depend on environmental factors, the design life, and material properties of the embedded element.

5.5.8 pH of Soils for Non-Corrosive Applications

Measurement of the pH of soils also has uses other the corrosion testing. One application is testing the soil pH to detect the presence or absence of lime in the soil. Although not required as part of the [Standard Specifications](#), pH testing can be used as a technique in the control of lime stabilization and modification projects, by measuring the pH after addition of various quantities of lime.

Another use of the pH of a soil is to evaluate the suitability of soils for sustaining vegetation growth (landscaping grasses, etc.). This can determine the relative need for the addition of chemicals, such as agricultural lime (to sustain growth of landscaping grasses). Many soils are, naturally, rather acidic. Plant life can be increased markedly by the addition of basic chemicals such as lime.

When testing for uses other than corrosion testing, ASTM D 4972, titled “Standard Test Method for pH of Soils” is used.

5.5.9 Triaxial Compression Tests

The triaxial compression test is a universally applicable compression test for determining the shear strength parameters of soils. This test may be performed on all soils, ranging from cohesive to cohesionless.

The triaxial compression test can be performed via three different test methods. These include the unconsolidated-undrained (UU), consolidated-undrained (CU), and consolidated-drained (CD) test methods. There are some differences in the testing procedure between the UU, CU, and the CD tests. These differences are based, primarily, on the drainage conditions during the test.

[Figure 5.5.9-1](#) shows a schematic diagram of the triaxial test apparatus. The test consists of applying an equal, all-around pressure (σ_{cell} or σ_3) to a specimen in a triaxial chamber; and then subjecting the specimen to a gradually applied (strain controlled) axial loading, known as the deviator stress (as shown in [Figure 5.5.9-2](#)). Generally, three specimens, as nearly identical as possible, are needed with each tested at a different confining pressure. The results are, then, plotted on a Mohr circle diagram to define the failure envelope similar to those shown in [Figure 5.5.9-3](#).

As an alternative to using multiple specimens, a multi-stage triaxial test can be conducted. For this staged testing, one specimen is used for multiple confining pressure applications. Normally, one test is performed at each of three different confining pressures, and the results plotted (as shown in [Figure 5.5.9-3](#)) on a Mohr circle diagram.

5.5.9.1 Unconsolidated-Undrained Test Method

The UU triaxial test is the most common test method. For this test, no drainage from the sample is permitted, either during the application of the confining pressure, or during the axial loading to failure. The UU test is to be conducted according to the AASHTO T 296, "Unconsolidated, Undrained Compressive Strength of Cohesive Soils in Triaxial Compression". The results from this test are used for evaluating failures which occur rather quickly; such as, slope stability failures during or at the end of construction, particularly, if the embankment and foundation soils are primarily clayey or relatively impervious.

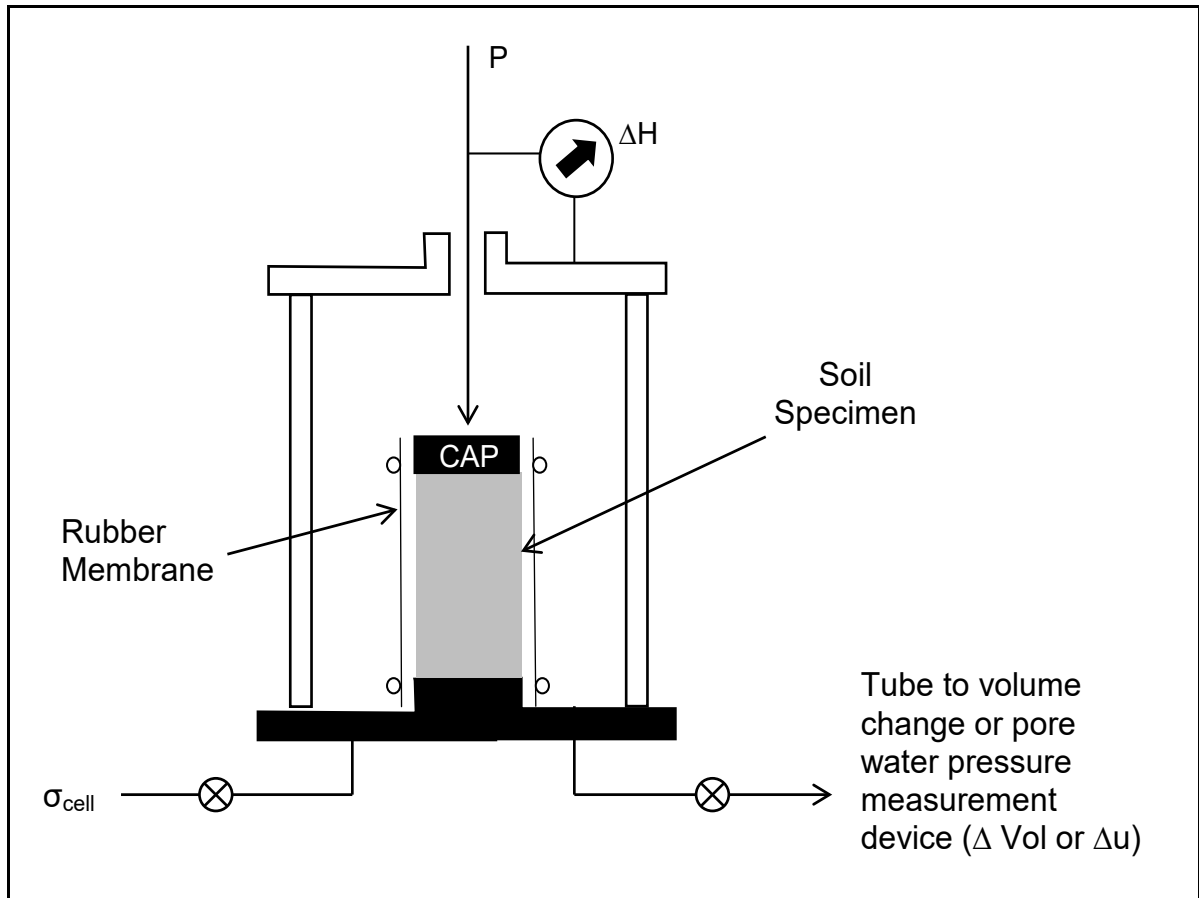

Figure 5.5.9-1 Schematic Diagram of the Triaxial Test Apparatus

5.5.9.2 Consolidated-Undrained Test Method

The CU test is to be conducted according to ASTM D 4767 / D 4767M, "Consolidated Undrained Triaxial Compression Test for Cohesive Soils". (AASHTO T 297, "Consolidated, Undrained Triaxial Compression Test on Cohesive Soils" has been discontinued.) In this test method, the drainage is allowed to take place during the application of the confining pressure, but not during the application of the deviator stress. The CU test results are, commonly, applied to the determination of slope stability, subjected to rapid drawdown conditions, long after an embankment is constructed on a river front, for example, or when a relatively slow embankment construction is expected.

From the UU test, Mohr circle diagrams can be constructed without regard to pore water pressures. This is referred to as a total stress analysis. If pore water pressure measurements

are made, they are, commonly, made in the CU test. Mohr diagrams, adjusted for pore water pressure, result in an effective stress analysis.

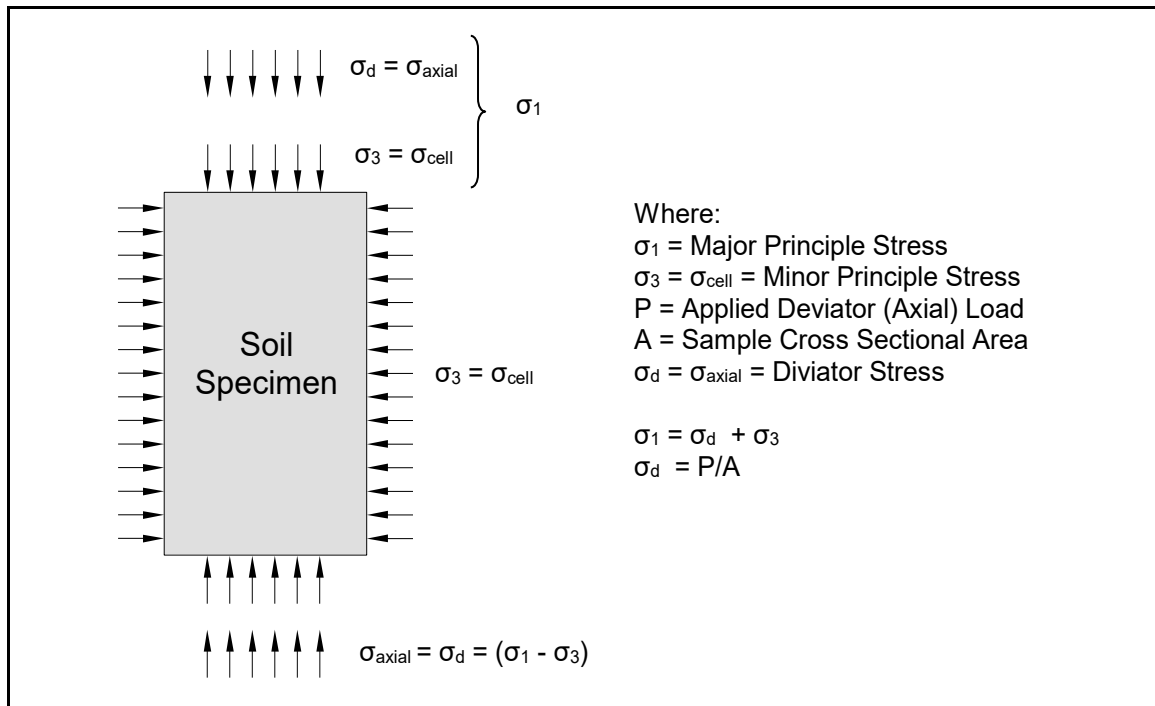

Figure 5.5.9-2 Diagram of the Assumed Stress Conditions for Triaxial Compression

5.5.9.3 Consolidated-Drained Test Method

Although seldom used, the CD test is to be conducted according to ASTM D 7181, “Consolidated Drained Triaxial Compression Test for Soils”. In this test method, drainage is permitted (at all times) by allowing the drainage valves to remain open throughout the test so that no pore water pressures are allowed to develop during the application of either the confining pressure or the deviator stress. The stress difference is then applied slowly to prevent excess pore water pressure during the shearing stage. The CD test results are applicable only to relatively free-draining soils not subject to liquefaction; and to semi- pervious soils subjected to steady seepage conditions in which loads are slowly applied, and changes in moisture content and volume are not impeded. For relatively impervious soils, it is doubtful that conditions represented by the slow test can actually take place in an embankment, because loads are applied too rapidly to allow for dissipation of pore pressures and volume changes within the soil mass. The CD test provides data for effective stress analysis, in which the effective cohesion (c') and effective friction angle (ϕ') are used.

5.5.9.4 Triaxial Strength Parameters for Coulomb Equation

The results of the various triaxial test methods are used to derive shear strength parameters. For soils, the shear strength is usually expressed by the classical Coulomb equation:

$$\tau = c + (\sigma_3 - u) \tan \phi \quad [\text{Eq. 5.5.9-1(a)}]$$

Where:

τ = Shear strength

c = a constant usually called cohesion

σ_3 = external pressure on specimen (confining pressure)

ϕ = angle of internal friction

u = water pressure in the soil pore spaces.

For cohesionless soils, such as sands, $c=0$ and the Coulomb equation reduces to:

$$\tau = (\sigma_3 - u) \tan \phi \quad [\text{Eq. 5.5.9-1(b)}]$$

For saturated clay soils, the equation for practical purposes can be reduced to:

$$\tau = c \quad [\text{Eq. 5.5.9-1(c)}]$$

Mohr circle plots, for several situations, are illustrated in [Figures 5.5.9-3](#) (a), (b) and (c). A primary reason for the preparation of a Mohr circle diagram is to determine the values of the cohesion intercept, c (total) or c' (effective), and the angle of internal friction, ϕ (total) or ϕ' (effective).

As shown in [Figures 5.5.9-3](#) (a) and (c), as the soil sample approaches a saturated condition, the cohesion intercept becomes greater, while the angle of internal friction becomes smaller. Finally, for a true saturated clay, on a total stress basis, the angle ϕ becomes zero and the cohesion is equal to one-half the deviator stress.

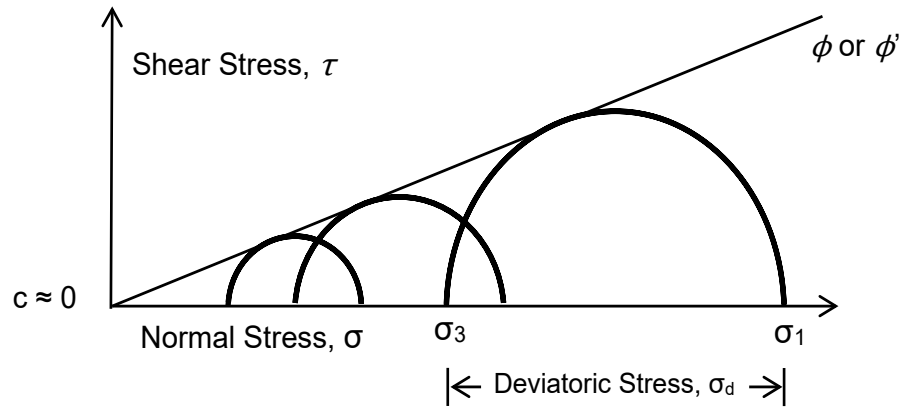

a) UU test on granular (cohesionless) soils; CU or CD tests on other soils, with or without pore water pressure measurements.

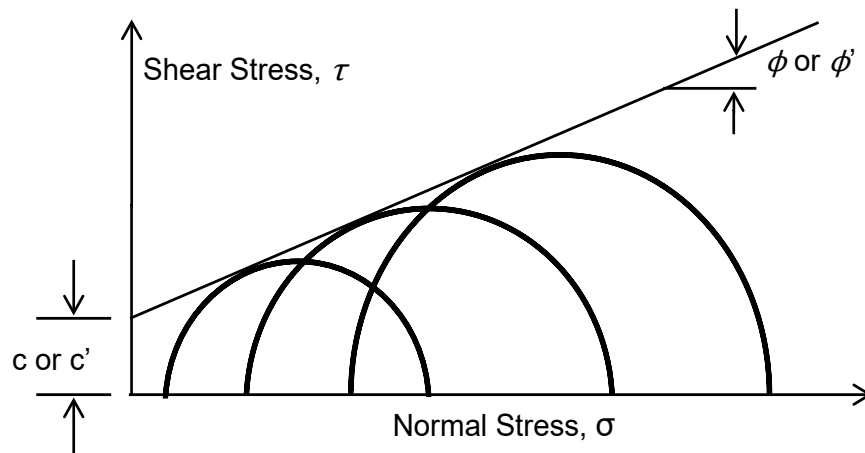

b) UU or CU tests on partly saturated fine-grained (cohesive) soils, with or without pore water pressure measurements.

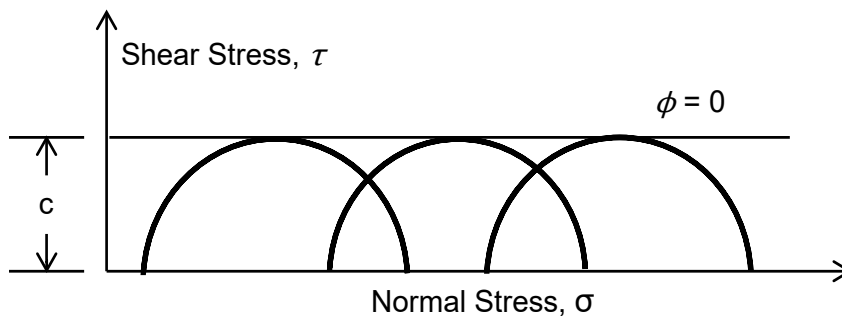

c) UU tests on fully saturated fine-grained (clayey) soils.

Figure 5.5.9-3 Typical Mohr Failure Diagrams for Triaxial Tests on Various Types of Soils

5.5.10 Unconfined Compression Test

The unconfined compression test, commonly referred to as the Q_u test, is performed according to AASHTO T 208, "Unconfined Compressive Strength of Cohesive Soil". This test is a special case of a UU triaxial compression testing in which the confining pressure, σ_3 in [Figure 5.5.9-2](#) is zero. It is performed by loading a cohesive soil specimen at a constant strain rate, while unconfined, and measuring the force required to cause deformation in the specimen. The force and deformation test data are recorded and calculated to determine the stress (force/cross sectional area, P/A) required to cause failure, after adjusting for strain corrections. This point is referred to as the " Q_u " and expressed in units of tons per square foot (tsf). Failure is defined as the peak stress or stress at 15% strain (unless specified otherwise), whichever is reached first. The results are summarized on the "Shelby Tube Test Results" form [BMPR SL24](#).

It is important to note that, in this stress state, the angle of internal friction (ϕ) is assumed to be zero. As such, the undrained shear strength (s_u) becomes equivalent to the material's undrained cohesion (c_u), which is equal to one-half Q_u (i.e., $c_u = s_u = Q_u \div 2$). Note that the unconfined compression test cannot be conducted on granular or completely cohesionless soils because the test specimen is not supported in any manner during the test.

5.5.11 Direct Shear

Another method for determining soil shear strength parameters is AASHTO T 236, "Direct Shear Test of Soils under Consolidated Drained Conditions". This test is rarely used by the Department. However, it is one of the test methods specified in Articles 1003.07 and 1004.06 of the [Standard Specifications](#) for determining the internal friction angle of MSE wall select fill, which is required as part of the material approval process prior to its use. Use of this test for any other purpose shall require prior approval from the CBM.

The direct shear test can be performed on both cohesive and cohesionless soils and on either intact (relatively undisturbed) or remolded specimens. Unlike a triaxial or unconfined compressive strength test, the direct shear test method has a forced horizontal failure plane near the middle of the specimen. This failure plane may not be the weakest plane; and thereby, it may overestimate the shear strength parameters. Alternatively, to take advantage of the forced failure plane, the direct shear test can be used for determining the shear resistance along recognizably weak

planes within a soil mass or between dissimilar materials, such as between a soil and a foundation material.

5.5.12 Compressive Strength of Rock

The uniaxial compressive strength of intact rock core specimens is determined by testing according to ASTM D 7012, Method C except that the test results are reported in tons per square foot (tsf). There are four methods (A to D) outlined in ASTM D 7012, "Compressive Strength and Elastic Moduli of Intact Rock Core Specimens under Varying States of Stress and Temperature". Method C: "Uniaxial Compressive Strength of Intact Rock Core Specimens" is an unconfined test procedure. This method is used for obtaining strength determinations, and strain is not typically measured. As such, a stress-strain curve is not produced. This test procedure is similar to the unconfined compression test for cohesive soils. However, failure in this test is defined as the maximum load sustained by the specimen. The compressive strength (Q_u) results are reported in tons per square foot (tsf).

The moisture condition of specimens at time of test can have a significant effect upon the indicated strength. Through Departmental experience, this effect is particularly observed with shale specimens. Good practice generally dictates that laboratory tests be made upon specimens representative of field moisture conditions. Thus, it follows that the field moisture condition of the specimen should be preserved until time of test, and the tests performed as soon as practical.

5.5.13 Consolidation Tests

The consolidation of a foundation soil is an important factor in embankment design when the proposed fill is founded on thick strata of relatively compressible, low permeability soils such as clay. When a compressible foundation soil is encountered below an area where a footing or an embankment is to be constructed as discussed in [Section 3.4.4.3](#), it is the Department's standard practice to obtain continuous Shelby tube samples (or other intact, relatively undisturbed sampling systems) throughout the entire depth of the boring so that consolidation tests and settlement analyses can be performed before final design is completed.

One-dimensional consolidation test results are used in settlement analysis procedures for estimating primary and secondary consolidation. [Section 5.5.13.1](#) describes the one-dimensional consolidation test, and settlement analyses procedures are outlined in [Appendix D](#).

In soil mechanics, the term consolidation is applied to the phenomenon of the gradual transfer of an applied load, from the pore water to the soil structure. It is a time-dependent deformation, in a soil mass, due to applied loads. Consider a mass of soil with the void spaces completely filled with water, and the water in hydrostatic balance, wherein, pressures correspond to the depth below the groundwater table. When a load is rapidly applied, the soil will compress; but some of the pore water is forced out, in the manner of a saturated sponge that has been squeezed. The amount of water which escapes depends on the size and duration of the load, and on the compressibility of the soil. The rate at which it can escape depends on the permeability of the soil, and the thickness of the stratum (or the distance to a relatively free-draining material). The more pervious the soil, the faster it will drain; thick strata drain more slowly than thin ones. The consolidation of a stratum is reflected by a settlement or (lowering) of the embankment surface, or the footing above it.

In areas underlain by deep beds of clay, structures or embankments have been known to settle a foot or more, over a period of years, because of the low permeability of clay. However, if the same structures were founded on compact sand and gravel, the consolidation settlement would be negligible, and all the settlement would likely take place by the time construction is finished, because of the high permeability of these granular soils. The consolidation phenomenon applies, also, to sands and gravels. However, it is of little practical significance, since such soils permit rapid escape of water, and are incompressible when properly densified, in comparison to clays.

Some saturated, highly plastic clays may consolidate even without being subject to additional loads. Such settlements are induced by the removal of pore water by transpiration from heavy vegetation, especially trees, during periods of below normal rainfall. These settlements are largely unpredictable and can be avoided, **only** by preventing the growth of large trees and shrubs adjacent to roadways and structures.

The shearing strength of soil is affected by consolidation. If a foundation consolidates slowly, relative to the rate of construction, a substantial portion of the applied load will be carried by the pore water, which has no shearing strength. Therefore, when the soil shearing strength is sufficiently diminished, a shear failure can occur. This matter requires certain evaluation, as it affects the choice of one of several corrective procedures. If the evaluation indicates that the construction time frame allows for the dissipation of excess pore water pressures, the soil may gain some shear strength by consolidation.

Consolidation of the foundation will, occasionally, prove to be a governing factor in the choice of a bridge site. Further, it will be a factor in the design, and may necessitate special design and construction procedures, to reduce possible detrimental settlement.

5.5.13.1 One-Dimensional Consolidation and Settlement

Consolidation tests are conducted on intact (relatively undisturbed) samples according to AASHTO T 216, "One-Dimensional Consolidation Properties of Soils", and the results are used in settlement analysis procedures for estimating primary and occasionally for secondary consolidation, which are outlined in [Appendix D](#). The test specimen is considered a small model being used to represent a much larger mass of soil, as it exists at the site being studied, assuming the soil stratum is homogenous. The small specimen must be as nearly undisturbed as possible, because the test results will tend to magnify any disturbance and the soil properties could be significantly misinterpreted.

The consolidation test consists of applying a series of pressure (load) increments on the soil specimen. The load increments should be in the same range of anticipated design loads. At each load increment, readings of deformation with time are taken for a minimum loading period of 400 minutes or longer. If secondary compression is a concern, the load increment is applied until the linear portion of the secondary compression appears. This procedure is repeated for the subsequent pressure increments and may be customized with unloading and reloading cycles to simulate rebound and recompression situations.

The results of the consolidation test readings, for the various pressure increments, are usually expressed by plotting the deformation dial reading versus the log of time, and the deformation dial reading versus the square root of time on separate plots (as shown on [Figures D.5-1](#) and [D.6-1](#), respectively). From this data, the void ratio (e) versus the log of pressure ($\log P$) is then plotted (as shown on [Figure 5.5.13.1-1](#)). The shape of the e - $\log P$ curve is of considerable significance. For example, in [Figure 5.5.13.1-1](#), curve 1 indicates that the Shelby tube sample or the small specimen was considerably disturbed; while curve 2, probably, indicates a relatively undisturbed material; and curve 3 illustrates a material which is rather sensitive or "quick". An important result obtained from an e - $\log p$ curve, for a given specimen, is the determination of the compression index (C_c); which is defined as the slope of the lower straight line portion of the e - $\log p$ curve. The C_c is often determined from the straight line portion of the laboratory test specimen. However, it is IDOT standard practice to use the C_c obtained from the field "virgin" e -

log p curve (curve 4). The procedure for developing the field “virgin” curve is presented in [Appendix D.9.1](#).

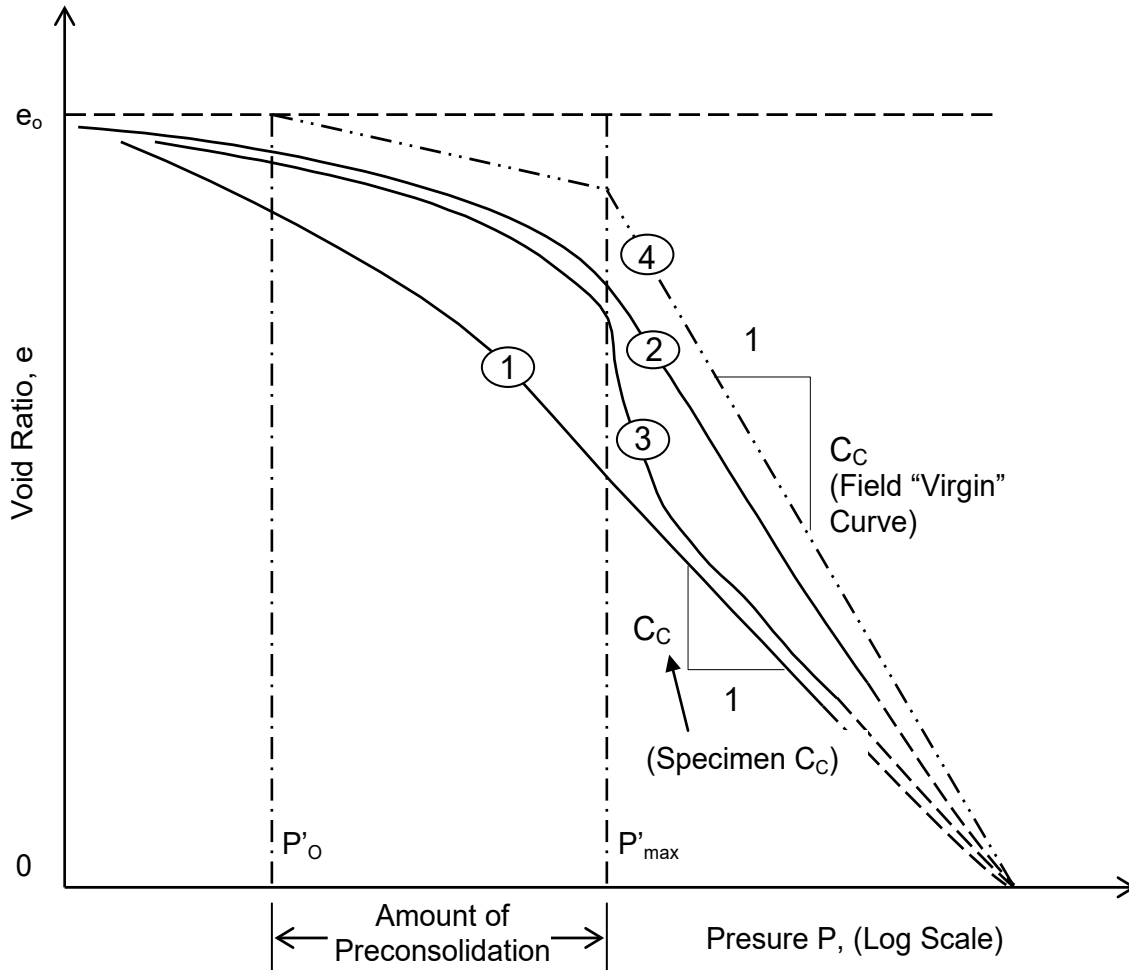

Figure 5.5.13.1-1 Void Ratio vs. Log Pressure Curves Typical of Various Clay Samples

For normally consolidated soils where both the existing pressure ($P'_o = P'_{max}$) and the anticipated applied pressure ($P'_o + \Delta P'$) are within the straight line portion of the field “virgin” curve, the settlement may be computed from [Equation 6.9.1.1-2](#) (Chapter 6), which is repeated as [Equation D-9.2-2](#). If the applied loads are outside the linear range (typical of overconsolidated soils), where the slope varies with the load, [Equation D.9.2-1](#) or [Equation D.9.2-3b](#) (Appendix D) should be used. [Equation D.9.2-4](#) may also be used for overconsolidated soils if ($P'_o + \Delta P'$) is less than P'_{max} .

It should be noted, that the consolidation test yields an approximate value of settlement caused by removal of water from the pore spaces of a saturated soil. The test does not give any indication of probable embankment, or structural settlement caused by bearing capacity failure, or secondary compression. Settlement may also result from rearrangement of soil grains during vibrational or earthquake loadings, or from chemical deterioration in highly organic soils or peat deposits. These factors produce, largely, unpredictable settlements from laboratory tests. Engineering judgment should be considered, for the settlement forecast obtained from the conventional consolidation tests.

5.5.13.2 Swelling and Rebound

Swelling or expansive soils exhibit behavior opposite to consolidation. Soils such as highly desiccated clays, heavily overconsolidated clay tills, and soft rocks (clay shales), tend to rebound or swell when some of their overburden load is removed, particularly when exposed. They readily absorb groundwater, or water from the atmosphere, and increase markedly in volume. A judicious selection of loading increments and a proper loading-unloading pattern, while conducting the AASHTO T 216 consolidation test, will allow determination of the recompression index, swelling potential, and provide an insight into the past consolidation history of the soil strata.

5.5.13.3 Approximate Method for the Compression Index

It has been found that C_c is closely related to the LL value for normally consolidated clays. Therefore, for a first hand estimate of the settlement, the statistical relationship in [Equation 6.9.1.1-1](#) between C_c and LL may be used in conjunction with [Equation 6.9.1.1-2](#).

It should be stressed, however, that this relationship is valid **only** for relatively insensitive, normally consolidated clays. It overestimates the settlement, for overconsolidated clays; such as, glacial tills, or for silty or sandy soils. This equation, if used to estimate the consolidation of a clay till for example, may yield a result 4 to 10 times greater settlement than a companion consolidation test. The use of this relationship always leads to, too great an estimate of settlement estimate, except in those rare cases (in Illinois) where sensitive clays are present. If the clay is sensitive, the estimate might be on the low side. The time required for different degrees of consolidation to occur may be computed using [Equation D.9.3-1](#).

5.5.14 Moisture-Density Relationship of Soils

The moisture-density relation of soils is obtained according to Illinois Modified AASHTO T 99 and is described in [Section 5.5.14.1](#). In 1933, R. R. Proctor published a series of articles in the Engineering News Record in which he discussed his conclusions; that the moisture content and the density of a soil were directly related during and after the compaction process. He used a penetration needle device to further delineate soil types, their moisture-density relationship and their strength.

Proctor concluded that greater density almost always results in greater strengths and less compressibility. Soil density, and the inferred degree of soil strength are influenced by three principal factors: 1) moisture content of soil, 2) nature of soil [gradation, chemical, and physical properties], and 3) type and amount of compactive effort. Using Proctor's work as a basis, pavement design criteria based on moisture-density relationships has become a common practice. It is now a standard practice to determine the maximum dry density of a given soil, in the laboratory, under standard conditions; and then compare this density, to the actual dry density achieved in the field. Specifications to control field compaction work are written in relationship to these two densities.

The typical relationship between moisture content and density, for different soil types prepared at a given compactive effort, is shown in [Figure 5.5.14-1\(b\)](#). As the moisture content of a soil increases from some initial dry condition, the density increases up to a maximum value, at an optimum moisture content (OMC). Addition of water beyond the optimum results in separation of soil particles and decreases the density.

The nature of the soil, itself, plays an important part in the moisture-density relationship. Of primary concern are: the gradation, size, shape, and mineralogical composition of the individual particles.

Generally, as soils range from poorly graded to well-graded, the maximum density increases. Well-graded soils contain such a wide range of particle sizes that small particles fill the void spaces between large particles, thereby, increasing the maximum density. This situation cannot prevail when the aggregate is gap-graded or uniform in size. Whenever void space is replaced with soil grains, the density is increased.

The OMC is a function of the soil specific surface (total surface area of particles per volume). Fine grained soils have larger specific surface than coarse grained soils. This explains why clays exhibit higher OMC than sands.

The type and amount of compactive effort applied to a given soil will directly influence the moisture-density relationship obtained. In general, as the compactive effort is increased, the maximum density is increased, and the OMC is reduced. The moisture-density curve obtained in the laboratory, for a given soil, does not necessarily correspond exactly to the curve which would be obtained in the field, under quite different compaction conditions. Such field curves, obtained with various rollers at different numbers of passes, do correspond reasonably well with the laboratory curves. Both research and practice indicate that with the proper compaction equipment, no difficulty should be experienced in achieving 95% or more of the laboratory maximum dry density; provided, the soil in the field is at or near the laboratory OMC. The zero air voids curve [\[Figure 5.5.14-1\(b\)\]](#) represents 100% saturation. Therefore, compacting a soil with moisture content on this curve requires squeezing water out of the voids. If the soil is fine grained or has a significant fine grained component, excessive rolling will not achieve the desired density until the moisture content is lowered.

The shape of a moisture-density curve may be useful in relating the moisture to the strength characteristics of a soil. Sometimes, the strength versus moisture curve resembles the moisture-density curve for the same soil. If the strength versus moisture curve is available, it would be useful to superimpose such curve over the moisture-density curve to recognize the significance of deviation from the OMC as illustrated in [Figure 5.5.14-1\(a\)](#).

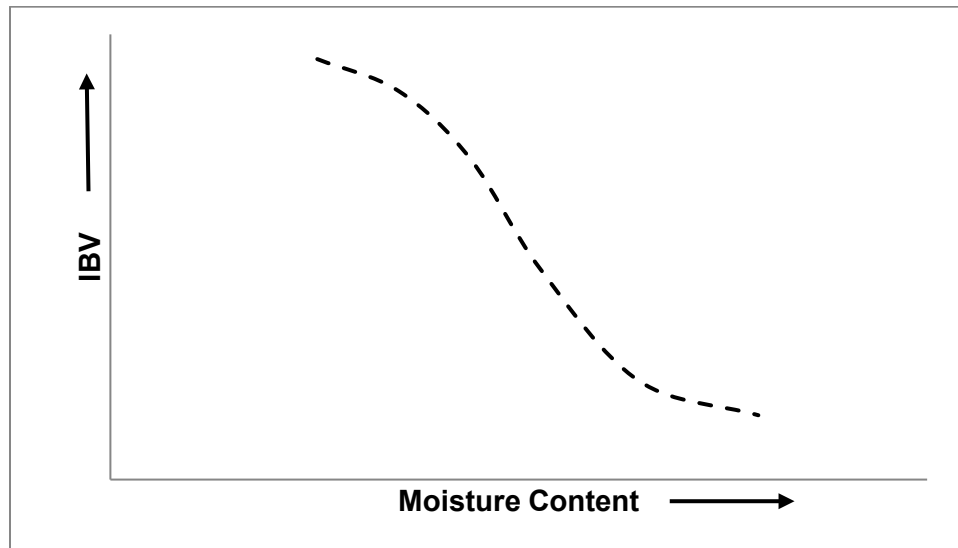

(a) Curve illustrating the typical change in IBV strength with moisture content.

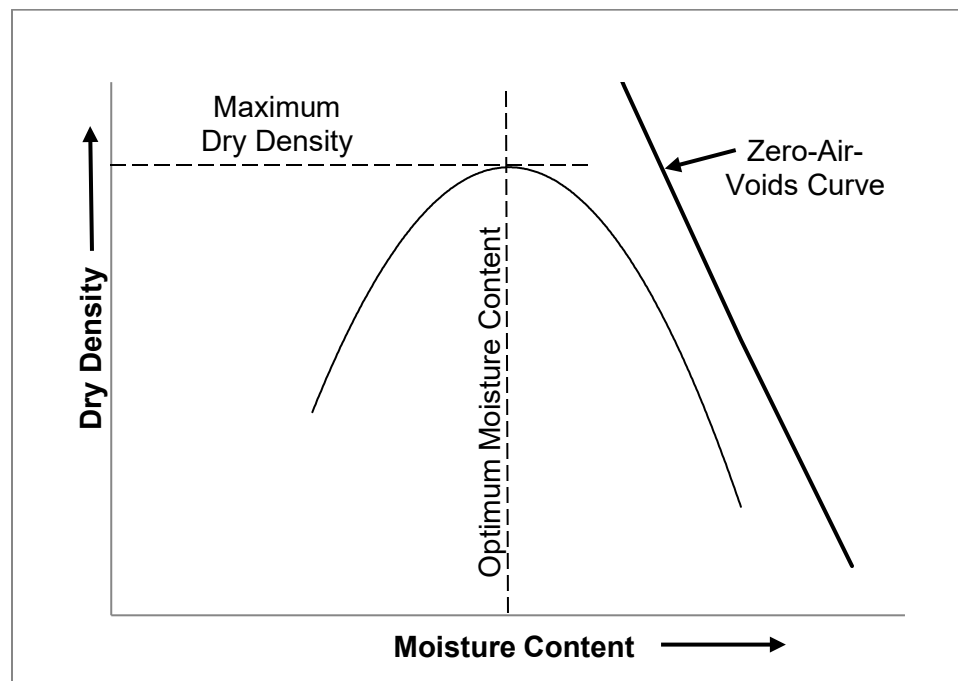

(b) Typical curve showing the relationship between moisture content and dry density. Zero-Air-Voids curve represents 100% Saturation.

Figure 5.5.14-1 Moisture-Density Relationship Curve with Corresponding IBV Curve

Knowledge of the soil OMC is important to the inspector and the contractor. Such knowledge allows a proper judgment to be made, relative to the required treatment of a soil, prior to compaction. If the soil has a moisture content considerably different from the optimum moisture content, it will be uneconomical to achieve the desired density merely by continued rolling. If the soil is below the optimum moisture content, additional water can be added and mixed in by blading or disking. If the soil has a water content above optimum, the contractor must remove water from the soil to obtain the desired density, at or near the optimum moisture condition. To remove excess water, the usual procedure involves scarification, to allow for evaporation. Some extreme cases have been resolved only by treatment with drying chemicals; such as, lime, or by removal of the excessively wet soil and replacement with a drier soil.

5.5.14.1 Standard Proctor Test

The Standard Proctor is used to determine the Standard Dry Density (SDD) and optimum moisture content (OMC) of soils and soil-aggregates for nearly all compaction control applications specified in the [Standard Specifications](#). This test is determined in accordance with Illinois Modified AASHTO T 99, “Moisture-Density Relations of Soils Using a 2.5-kg (5-lb) Rammer and a 305-mm (12-in.) Drop”, and Method C is predominantly specified.

The standard procedure is to use a minimum of four moisture density points to generate a moisture-density curve, as shown in [Figure 5.5.14-1](#). (To aid in defining the peak of this curve, an additional technique commonly recommended is to plot the wet density verses moisture content curve along with the dry density verses moisture content data points. Then, interpolate additional dry points (near the “dry” peak) via back-calculation from corresponding locations on the “wet curve”.) The maximum dry density and optimum moisture content (OMC) are derived from the dry density verses moisture content curve, where the maximum dry density is also referred to as the Standard Dry Density (SDD). Form [BMPR SL02](#) may be used to report test data and results along with an accompanying plot of moisture content verses density (preferably showing both the wet density and dry density curves).

If 5% or more of the material is oversized, a coarse particle correction should be applied to the test results according to Annex A1 in T 99, which was formerly Illinois Modified AASHTO T 224, “Correction for Coarse Particles in the Soil Compaction Test”. Lesser percentages can also be adjusted if desirable.

5.5.14.2 Modified Proctor Test

The Modified Proctor Test is also used on a limited basis. This test is conducted according to Illinois Modified AASHTO T 180, "Moisture-Density Relations of Soils Using a 4.54-kg (10-lb) Rammer and a 457-mm (18-in.) Drop". It is very similar to the Standard Proctor Test except that it increases the amount of energy required for compaction by using a heavier rammer and with a greater fall height and an increased number of soil layers in the cylindrical mold. This reflects an increased compactive effort in the field, and it results in a higher maximum dry density and correspondingly lower OMC compared to the Standard Proctor.

This test is rarely used by the Department. However, it is specified in the 2012 Edition of the [Standard Specifications](#) for compaction of pozzolanic stabilized subbase material with an additional modification (using 3 lifts instead of 5 lifts in the mold). Use of this test for any other purpose shall require prior approval from the CBM.

5.5.14.3 Zero-Air-Voids Curve

The zero-air-voids curve represents the moisture-density relationship for a fully saturated soil, i.e. when the volume of air voids is zero [as shown in [Figure 5.4-1\(b\)](#)]. The curve helps field personnel check the validity of the compaction curve, for a particular soil. The dry density (ρ_d) can be plotted versus the moisture content (w), to establish the zero-air-voids curve on a moisture-density graph as shown on [Figure 5.5.14-1](#), using the following equation:

$$\rho_d = \frac{(G_s)(\rho_w)}{1+(w)(G_s)} \quad (\text{Eq. 5.5.14.3-1})$$

Where all symbols are as defined in [Table 5.4-1](#).

5.5.14.4 One-Point Method and Family of Curves

The SDD and OMC of a soil may be established by compacting one point per Illinois Modified AASHTO T 99 on the dry side of optimum, plotting the resulting density and moisture content on a family of moisture-density relationship curves, and selecting the curve that best fits the plotted point. This one-point method is performed according to Illinois Modified AASHTO T 272, "One-Point Method for Determining Maximum Dry Density and Optimum Moisture", where the family of

curves is developed following the guidance in Illinois Modified AASHTO R 75, "Developing a Family of Curves". The one-point method is commonly used in the field for testing and inspection of embankment construction. As such, refer to [Section 4.7.1.1](#) for more detailed discussion on the test method.

5.5.15 Relative Density Testing

Relative Density Testing is used for some aggregates instead of a moisture-density relationship curve. The most common application is for determining a maximum index density of some open graded aggregate gradations used as MSE wall select fill. Relative density determinations are performed according to ASTM D 4253, "Standard Test Methods for Maximum Index Density and Unit Weight of Soils Using a Vibratory Table" and D 4254, "Standard Test Methods for Minimum Index Density and Unit Weight of Soils and Calculation of Relative Density".

Aggregates which do not contain an appreciable amount of fines can have difficulty in developing a moisture-density relationship curve ([Section 5.5.14](#)), and in some cases, a curve may not develop. Relative density testing provides an alternative means of assessing the degree of compaction for these aggregates. This is done by determining minimum and maximum index densities. A minimum index density is established by placing aggregate in mold of known volume in a free fall manor with as little disturbance as possible in an effort to establish as loose a state as possible. A weight is placed on the loose aggregate, and the sample is vibrated at a specified frequency over a specified time in order to densify the material establishing a maximum index density. Field density measurements can be compared with these minimum and maximum index densities in order to assess the field density relative to the index densities.

5.5.16 Illinois Bearing Ratio (IBR) Test

The IBR values are used for certain pavement design methods. They have been correlated with pavement performance over long periods of time and under various traffic and climatic conditions. Typical ranges of IBR values for soils, in Illinois, are given in [Table 5.5.16-1](#).

The Illinois Bearing Ratio (IBR) test is to be conducted according to the procedure described in [Appendix B.2.1](#). The IBR is the same as the original California Bearing Ratio (CBR) test, developed by the California Division of Highways in 1928. In the original procedure, specimens were compacted using a static molding technique. In later years, as other states adopted this

procedure, the method of molding was changed from a static procedure to a dynamic procedure, using a compaction hammer, as specified in AASHTO T 193 for the current CBR test procedure. The IBR test is a form of a punching shear in which a piston is pushed into a compacted soil creating a bearing capacity failure at the surface of the specimen. The test is conducted on a compacted soil sample in a 6 inch mold at the end of a four-day soaking period, during which the amount of swell is also measured.

The IBR is the ratio (expressed in percent) of a piston load at a certain penetration into the soil to the piston load applied to a typical crushed stone material at the same penetration. The piston should have a cross-section area of 3 in.², and the IBR is calculated at 0.2 in. penetration. For which, a large number of tests showed that the standard crushed stone yields an average piston load of 4,500 lbf at 0.2 in. penetration. The IBR is used in lieu of the CBR, because the standard piston loads of the crushed stone were based on the original test specimens, which were prepared by static compaction.

The percent of swell exhibited by the soil specimens, during the four day soaking period, serves to indicate potential problems associated with undesirable volume change in the subgrade soil. Soils indicating a swelling percentage greater than 3% are generally undesirable for subgrade or embankment soil and should signal a search for more desirable materials.

There are some problems and inconsistencies in the IBR test. The principal ones are:

- 1) Results of the IBR test can be influenced by the effects of surface composition and character of the specimen at the point of penetration in fine grained soil samples.
- 2) Results for coarse grained material can be affected by a constraining influence from the sides of the mold upon the specimen failure.

Soil Group AASHTO M 145	Probable IBR Range, %
A-1	15 – 40
A-2-4, A-2-5	8 – 20
A-2-6, A-2-7	6 – 20
A-3	5 – 15
A-4, A-5, A-6	2 – 10
A-7-5, A-7-6	1 – 8

Table 5.5.16-1 Typical IBR Values for Illinois Soils

5.5.17 Immediate Bearing Value

The IBV test is to be conducted according to the procedure described in [Appendix B.2.2](#). During the latter 1950's, the Illinois Division of Highways chose the IBR, defined in [Section 5.5.16](#), for pavement design until the Mechanistic Pavement Design (MPD) method was developed in 1982. The MPD method does not rely on the IBR values, because the subgrade is not included in the pavement structure. However, the subgrade soil stability is still important under heavy construction traffic. Therefore, an IBV test was developed to determine a bearing value for the subgrade soil immediately after compaction (without soaking). The IBV is determined in the lab from a penetration test similar to that described for the IBR, except that the test is conducted immediately after compacting the soil in a 4 or 6 inch mold (depending upon the soil type) without soaking. The IBV can also be indirectly determined from a field DCP or SCP test as discussed in [Section 4.7.2.1](#) or [Section 4.7.2.2](#), respectively. The IBV is used to determine the stability of treated and untreated subgrade soils during construction. It is also used to determine the optimum mix design for treated subgrade soils, as will be discussed in [Section 5.6](#). The IBV is currently used to make a preliminary estimate of the depth of remedial treatment in weak subgrade soils, as recommended in the [SSM](#). The actual depth of soil treatment is typically verified with the DCP or SCP during construction.

It can be useful to superimpose an IBV strength versus moisture curve over the moisture-density curve to understand the variation in IBV strength with respect to the OMC for a material. This is accomplished by performing an IBV test on each of the molded samples in a Proctor test and plotting the moisture content versus IBV as shown in [Figure 5.5.14-1\(a\)](#). Soils typically lose strength with increasing moisture content, and the rate of strength loss typically tends to increase

when the moisture content is greater than the OMC. The loss of strength past OMC for moisture sensitive silts can be an especially steep curve as compared to that for clays, and it is generally more gradual for granular soils.

5.5.18 (Reserved)

5.6 Soil Modification and Stabilization Mix Design Procedures

Soils and aggregate are sometimes treated with additives such as lime, cement, or fly ash for different purposes. The most common applications include soil modification of subgrades and stabilization of subbases and base courses. Soil modification is the treatment of subgrade soil with an additive to provide a stable working platform under construction traffic. Stabilization is the treatment of soil or soil-aggregates with an additive to increase the IBR and strength of the mixture such that the stabilized material becomes part of the pavement structure. Because a longer design life is required, stabilization applications have greater strength and durability requirements than soil modification options. In each case, a laboratory evaluation and design procedure is performed to determine the “optimum” and economical amount of additive that results in the required performance. Mix design procedures have been implemented for both soil modification and stabilization applications. These procedures are discussed in the following subsections and outlined in [Appendix B](#).

5.6.1 Soil Modification Mixtures (Lime, Fly Ash, Slag Cement, Portland Cement)

The laboratory evaluation and design procedures for soil modification with the various permissible modifier additives are outlined in [Appendix B.3](#). Soil modification is the treatment of subgrade soil with a modifier to provide a stable working platform under construction traffic. The optimum modifier content is the percent modifier that provides a minimum IBV of 10 at 110% of the OMC in the laboratory.

Modifier additives used for soil modification include:

- By-product non-hydrated lime (lime kiln dust)
- By-product hydrated lime (hydrator tailings)
- hydrated lime
- lime slurry
- fly ash (Class C)
- Type IS Portland blast-furnace slag cement (slag-modified Portland cement)
- Type I Portland cement

Among these options, lime is the most commonly used material. However, soil must contain at least 15% clay content, determined according to AASHTO T 88, to be reactive with the lime. Organic material can also inhibit a soil from reacting with lime, and a soil is limited to a maximum 10% organic content as determined by AASHTO T 194 in the [Standard Specifications](#). The typical laboratory application rate for lime should be a maximum of 5%.

Occasionally a contractor chooses to use lime as a drying agent instead of a strength modifier. If the intent is to simply aid in the drying of the soil, rates of about 0.5% to 1% typically suffice.

Fly ash, slag-modified Portland cement, and Portland cement may be used with most soil types. They can be particularly beneficial in silty and sandy soils in which the clay fraction is insufficient for adequate reaction with lime.

Fly ash properties may be widely variable between different sources. One important concern is that fly ash has an increased potential for swelling if the sulfur trioxide (SO_3) content is greater than 5%. Fly ash also typically requires higher application rates compared to lime, and more than one pass of the rotary speed mixer may be necessary to obtain a homogeneous mixture.

For slag-modified Portland cement, laboratory evaluation of indicated that 2 to 5 percent of slag-modified Portland cement increased the IBV and the compressive strength of the mixture adequately to produce a modified or stabilized subgrade depending upon the soil type, moisture content, and curing time. Slag-modified Portland cement has two advantages over other additives, including Type I Portland cement. It requires relatively small percentages compared to fly ash and Type I Portland cement, and it works with all types of soil. However, its incorporation with some clay soils may require additional mixing to obtain a homogeneous mixture.

Laboratory testing shall be completed prior to performing soil modification in the field. Due to variability in material properties, both the soil and modifier additive materials tested in the mix design process should be from the same material sources to be used in construction.

5.6.2 Soil Stabilization Mixtures

5.6.2.1 Lime Stabilized Soil Mixture

Lime stabilized soil mixtures are used for subbases and base courses. The minimum recommended lime content is the percent lime that results in a strength gain of 50 psi in the stabilized soil over that of the untreated soil. Success with lime stabilization depends on the soil-lime reactivity which largely depends on the clay fraction in the soil. The soil shall contain a minimum of 15% clay in order to be reactive with lime. The material requirements for soil used in lime stabilization are discussed further in Article 1009.02 of the [Standard Specifications](#). The laboratory evaluation and design procedures for lime stabilized soil mixtures are to be performed according to [Appendix B.4](#).

5.6.2.2 Soil-Cement

In granular soils such as silts, sands, and gravels, the clay fraction is too small and the soil-lime reactivity too negligible to result in any improvements in the soil properties. In such instances, an alternative for stabilization is soil treatment with cement. The soil-cement mix design procedure is used to determine the optimum cement content that results in a minimum 7 day compressive strength of 500 psi without practically affecting the compaction characteristics and durability of the soil-cement mixture. Material requirements for soil used in a soil-cement mixture are discussed in Article 1009.03 of the [Standard Specifications](#). The laboratory evaluation and design procedures for soil-cement mixtures are presented in [Appendix B.5](#).

5.6.2.3 Cement Aggregate Mixture

Although rare today, cement aggregate mixture (CAM) is used as a stabilized subbase material in a pavement structure. The laboratory evaluation and design procedures for cement aggregate mixture are to be performed according to [Appendix B.6](#).

5.6.2.4 Pozzolanic Stabilized Mixture

Pozzolanic stabilized mixtures are a combination of aggregate, pozzolan (fly ash), and an activating agent of either Portland cement or hydrated lime. Although rare today, pozzolanic stabilized mixture is used as a stabilized subbase or base material. The laboratory evaluation and design procedures for pozzolanic stabilized mixture are to be performed according to [Appendix B.7](#).

5.7 Documentation of Laboratory Test Data and Results

Accurate and thorough documentation is required for each laboratory test and/or soil mix design. The following discussion provides guidance on documentation of laboratory test results for use predominately in developing the geotechnical reports discussed in [Chapter 7](#).

For most laboratory tests, only the test results are incorporated on to the logs and into the Geotechnical Reports. For tests performed in consultant laboratories, the copies of original test data and calculations shall be provided to the DGE upon request.

5.7.1 Laboratory Test Results

Many of the details required to be recoded for conducting laboratory tests are on forms specific to a laboratory's operating procedures or are recoded in specialized software programs used in data acquisition and processing test results. However, the Department has several IDOT forms available for documenting the results of many of the laboratory tests. Some test results, such as moisture contents from spit-spoon samples, are incorporated into the final boring log forms discussed in [Section 4.4.7](#). For other applications, the following list is of the most commonly used forms for reporting and summarizing laboratory test results in geotechnical studies:

- [BMPR 507A](#): Summary Report on Pavement, Base, and Sub-Base Design
- [BMPR 508A](#): Soil Test Data Sheet
- [BMPR SL02](#): Moisture-Density Worksheet
- [BMPR SL24](#): Shelby Tube Test Results

The applicability of these forms to a given project will be dependent upon types of laboratory tests conducted and their application in their application in the geotechnical study. These forms and other laboratory test worksheet forms mentioned throughout this chapter are available in Microsoft Word format on the IDOT website <http://www.idot.illinois.gov/> under the “Forms” tab on the **Soils page** (navigational path: [Home > Doing Business > Material Approvals > Soils](#)). Many of the lab test results can also be entered into a gINT project file ([Section 4.4.7.3](#)) for development of logs, profiles, graphs, tables, and some forms.

The “Summary Report on Pavement, Base, and Sub-Base Design” form [BMPR 507A](#) and the “Soil Test Data Sheet” form [BMPR 508A](#) are used in Roadway Geotechnical Reports for summarizing data and assisting in evaluation and development of recommendations. Examples of these forms are shown in [Figure 7.3.3.5-3](#) and [Figure 7.3.3.5-1](#).

The Moisture-Density Worksheet form [BMPR SL02](#) is used in construction materials testing as well as for geotechnical studies. However, a separate graph of the moisture-density curve is required to determine the OMC and maximum dry density.

The “Shelby Tube Test Results” form [BMPR SL24](#) provides a summary of laboratory test results from thin-walled tube samples. In addition to the project, location, and sample type information, this form contains the depth and elevation of each sample, moisture content (%), Q_u (tsf), wet unit weight (pcf), and a description of the sample. It also summarizes triaxial test results and test method. Any other tests performed should also be indicated on the form. Logs of Shelby tube borings are reported on the Soil Boring Log form. An example of a completed Shelby tube boring is shown in [Figure 4.4.7.1.4-1](#), and the corresponding laboratory test results are shown in the example Shelby Tube Test Results forms in [Figures 5.7.1-1\(a\)](#) and [5.7.1-1\(b\)](#).

5.7.2 Electronic Data Submittal

Requirements for electronic submittal of laboratory test data and results vary on a project-by-project basis as directed by the DGE. One of the most common forms of electronic submittal of field and laboratory test data is a gINT software project file ([Section 4.4.7.3](#)). Many of the lab test results can be entered into a gINT software project file for development of logs, profiles, graphs, tables, and some forms.



**Illinois Department
of Transportation**

Shelby Tube Test Results

Boring No.: C-12-ST Route: FAP-310 (US-67) Tube Length/Diameter: 30-in. / 3-in Page: 1 of 2
 Station: 958+41 Section: 42-4, 5 Ground Surface Elev.: 563.5 Date: 6/7/2013
 Offset: 10 ft. Lt. County: Jersey Begin Sampling Depth: 563.5 Job No.: D-98-008-04
 Latitude: n/a Structure No.: n/a Ground Water Elev.: 553.5 Soils Lab Project No.: 13002
 Longitude: n/a Contract No.: n/a Drilled by: CG (KEG) Prepared by: Kurt Schmuck

Sample No.	Depth (ft)	Elev. (ft)	Qu (tsf)	Moist. (%)	Unit Wt. (pcf)	c (psf)	Φ (deg)	c' (psf)	Φ' (deg)	Soil Type, Description and Observations
1-1	0.7	562.8	0.54	24.0	120.1					Brown Silty Clay-Loam w/ Silty Loam pockets
1-2	1.3	562.2	0.60	21.5	118.6					Same
1-3	2.0	561.5	0.42	24.3	114.0					Same
2-1	2.7	560.8	0.59	24.5	117.4					Borwn Silty Clay, top 1/2, to Dark Brown Silty Loam
2-2	3.3	560.2	0.44	24.8	113.4					Dark Brown Silty Loam w/ Silt pockets, top 3/4, to Brown Clay Loam
2-3	4.0	559.5	0.39	25.6	114.1					Dark Brown Silty Loam - clayey
3-1	4.7	558.8	0.31	23.2	113.9					Same
3-2	5.3	558.2	Cons	23.8	119.1					Dark Brown Silty Clay-Loam w/ isolated small stones
3-3	6.0	557.5	UU Tx	23.6	122.1	520	2.7	229	24.7	Dark Brown Silty Clay-Loam w/ Sandy Clay-Loam pocks, and iso, small stones
4-1	6.4	557.1	---	22.9	---					Gray Silty Clay w/ Sand and Silty Loam pockets-isolated small roots
4-2	7.1	556.4	0.43	22.9	122.4					Gray Silty Clay-Loam w/ small stones
4-3	7.7	555.8	0.58	24.6	122.3					Gray Silty Clay w/ Silty Loam and Sandy Loam pockets - small stones
5-1	8.5	555.0	---	21.8	121.5					Gray Silty Clay-Loam w/ Sandy Clay-Loam pockets and stones
5-2	9.2	554.3	0.56	21.1	125.8					Same - plus oxidized pockets
5-3	9.8	553.7	0.51	18.7	129.6					Gray Silty Clay-Loam w/ SaCL & SaL pockets - ox. - small & large gravel
6-1	10.7	552.8	---	21.3	125.1					Gray Silty Clay w/ oxidized Silty Loam pockets - heavy oxidized areas
6-2	11.3	552.2	Cons	19.8	130.9					Gray Silty Clay w/ Silty Loam pockets - oxidized - small stones
6-3	12.0	551.5	UU Tx	17.2	133.9	1742	3.4	1070	26.9	Same, top 3/4, to Gray Silty Clay fill - oxidized
7-1	12.7	550.8	3.48	15.8	135.2					Gray-Brown Silty Clay till
7-2	13.3	550.2	4.41	15.5	136.0					Gray-Brown Clay till
7-3	14.0	549.5	1.43	17.8	133.6					Same, top 3/4, to Gray-Brown Silty Clay till - softer
8-1	14.7	548.8	1.88	19.0	133.2					Gray-Brown Silty Clay to Gray-Brown Clay till
8-2	15.3	548.2	5.06	15.8	133.5					Gray-Brown Clay till

The Unit Wt. column represents the Moist Unit Weight.
 The Qu column represents the Unconfined Compressive Strength using AASHTO T 208.
 The c and Φ column represents cohesion and friction angle for total stress using AASHTO T 296 (unconsolidated-undrained triaxial testing).
 The c' and Φ' column represents cohesion and friction angle for effective stress using either AASHTO T 297 (consolidated-undrained triaxial testing), or AASHTO T 296 with pore pressure measurement.

Printed 11/23/2013 BMPR SL24 (Rev 12/27/11)

Figure 5.7.1-1(a) Example Completed Shelby Tube Test Results Form



Illinois Department of Transportation

Shelby Tube Test Results

Tube Length/Diameter: 30-in. / 3-in. Page: 2 of 2

Station: 958+41 Section: 42-4, FAP-310 (US-67) Date: 6/7/2013

Offset: 10 ft. Lt. County: Jersey Begin Sampling Depth: 563.5 Job No.: D-98-008-04

Latitude: n/a Structure No.: n/a Ground Water Elev.: 553.5 Soils Lab Project No.: 13002

Longitude: n/a Contract No.: n/a Drilled by: CG (KEG) Prepared by: Kurt Schmuck

Sample No.	Depth (ft)	Elev. (ft)	Qu (tsf)	Moist. (%)	Unit Wt. (pcf)	c (psf)	Φ (deg)	c' (psf)	Φ' (deg)	Soil Type, Description and Observations
8-3	16.0	547.5	5.94	16.8	135.2					Gray-Brown Clay till
9-1	16.7	546.8	3.85	17.2	134.5					Same
9-2	17.3	546.2	Cons	17.4	133.5					Gray Clay till - oxidized
9-3	18.0	545.5	UU Tx	16.8	135.0	4349	0.0	4349	0.0	Same
10-1	18.7	544.8	3.54	17.1	134.1					Same
10-2	19.3	544.2	4.56	16.8	134.3					Same
10-3	20.0	543.5	4.02	16.5	135.2					Same
11-1	20.7	542.8	2.37	16.5	134.4					Same
11-2	21.3	542.2	5.56	17.3	134.1					Same
11-3	22.0	541.5	---	---	---					No Recovery
12-1	22.7	540.8	2.29	18.5	133.5					Gray Clay till-oxidized
12-2	23.3	540.2	Cons	16.3	135.9					Gray - Brown Clay till
12-3	24.0	539.5	UU Tx	18.3	133.5	4982	3.6	5040	3.7	Same
13-1	24.5	539.0	---	17.0	135.4					Gray Silty Clay till
13-2	25.2	538.3	3.89	17.7	132.0					Same
13-3	25.8	537.7	2.46	21.6	128.4					Gray dense Silt w/ clayey Silt pockets
14-1	26.7	536.8	1.4	29.8	125.5					Greenish-Gray shaley Clay, top 1/2 , to Blue-Gray Silty Clay w/ Silt lenses
14-2	27.3	536.2	2.34	21.4	128.2					Blue-Gray Silty Clay w/ Silt lenses and vertically aligned Silt seams
14-3	28.0	535.5	1.68	23.2	126.5					Same
15-1	28.7	534.8	2.26	21.3	128.3					Greenish-Gray Silty Clay w/ isolated Silt pockets
15-2	29.3	234.2	Cons	20.5	128.9					Greenish-Gray Silty Clay w/ isolated small stones
15-3	30.0	533.5	UU Tx	20.4	128.0	3182	0.0	3182	0.0	Gray Silty Clay w/ isoated oxidized Silt pockets

The Unit Wt. column represents the Moist Unit Weight.
 The Qu column represents the Unconfined Compressive Strength using AASHTO T 208.
 The c and Φ column represents cohesion and friction angle for total stress using AASHTO T 296 (unconsolidated-undrained triaxial testing).
 The c' and Φ' column represents cohesion and friction angle for effective stress using either AASHTO T 297 (consolidated-undrained triaxial testing), or AASHTO T 296 with pore pressure measurement.

Printed 11/23/2013 BMPR SL24 (Rev 12/27/11)

Figure 5.7.1-1(b) Example Completed Shelby Tube Test Results Form

Chapter 6 Geotechnical Design

6.1 Introduction

Geotechnical design consists of analyzing and evaluating geotechnical data and project information to develop recommendations for incorporation into design plans and the project construction. The Department has established many geotechnical analysis procedures and design requirements related to roadways and structures. The intent of this chapter is to provide general guidance to identify soil and foundation concerns that need to be evaluated, and the current Department policies and requirements that the analyses and recommendations should satisfy. It is presumed the engineer is qualified, experienced and familiar with all aspects of geotechnical engineering as they relate to the behavior of earth structures, roadways, various transportation structure foundations, as well as Department policies and practices.

6.1.1 Analyses and Evaluations

With the soils exploration program completed and the data available, the geotechnical study is ready to proceed with analyses and evaluations. Good geotechnical analyses begin with quality data and a good understanding of the soil data, profile, and parameters.

The design analyses and evaluations contained in a Geotechnical Report shall be in compliance with current requirements given in this Manual, the [Subgrade Stability Manual](#), the [Bridge Manual](#), [Culvert Manual](#), Department specifications and design guides, AASHTO Specifications and design guides, as well as current published FHWA Manuals and guidelines. When there is conflict, IDOT's policies and requirements supersede any other requirements. Additionally, the term "analyses" in this manual does not, necessarily, include all the mathematics needed to analyze a certain situation.

6.1.2 Recommendations

Design recommendations are a key element of any Geotechnical Report. They are formulated from compilation and evaluation of data gathered through field exploration, laboratory testing, reconnaissance, analyses, as well as any project specific design constrains. With advancements in computer software and computational methods in geotechnical engineering, it has been

possible for engineers to conduct very complex analyses in a relatively short time. However, the variability in soil properties along roadway alignments could easily render the results of those analyses to be misleading rather than helpful. Therefore, it is very important to base the design recommendations on a combination of solid engineering judgment, the hard data that truly reflects the field and soil conditions, and the geotechnical analyses acceptable to IDOT.

The design recommendations shall include the description of any special treatment necessary to develop stability in embankments, cut slopes, subgrades, and structure foundations; and should warn of possible construction difficulties. Clear, complete, and specific design recommendations shall be provided to the designer, who may have little geotechnical knowledge. This enables designers to incorporate the design details and material quantities, needed for proper construction of the project, into the plans and special provisions. Vague recommendations are of no use to the designer; neither are alternate recommendations, without cost/benefit studies that allow the designer to select the most cost effective alternate.

The design recommendations shall be compatible with the [Standard Specifications](#), the [Supplemental Specifications and Recurring Special Provisions](#), various statewide special provisions ([BDE](#) and [GBSP](#)), and any applicable District Special Provisions. Standard procedures and materials are preferable, unless special needs justify special construction techniques, or materials. The design recommendations should include a recommended special provision for all project specific construction techniques or materials, except as noted in the next paragraph. Construction and material inspection, testing, and acceptance (according to IDOT practice and testing capability) shall also be addressed in the special provision. Refer to [Section 6.16.2](#) for guidance on development of Project Specific Special Provisions.

For some situations, the design recommendations may only need to recommend that a special provision be developed, in lieu of including a recommended special provision. This would be determined by the Department on a project-by-project basis and may result from the situations such as the need for addition information or the anticipation of a future Geotechnical Design Memorandum.

When more than one Geotechnical Report is developed for a particular project, the recommendations shall be coordinated the between the reports (i.e., between RGRs and SGRs) such that they do not conflict or employ different and/or incompatible treatments in the same location.

6.2 Roadways Overview

Geotechnical design elements for roadways mainly focus on roadway subgrades, embankments, and cut sections. Subgrades and embankments are evaluated in two phases: during the geotechnical study in the design phase, and during the construction phase. The design phase evaluation is utilized to formulate recommendations for incorporation into project plans and special provisions. Due to variability in soil properties between boring locations along roadway alignments, a second evaluation is performed during construction in order to adjust limits of any recommended treatments or address any unanticipated conditions encountered during construction. This chapter primarily focuses on development of recommendations for the Geotechnical Report, and [Chapter 8](#) discusses construction inspection evaluations.

In the design phase geotechnical study, subgrades and embankments are evaluated to: 1) provide the soil parameters needed for pavement design; 2) identify potentially problematic soil and drainage conditions which could affect construction and long term performance, if any; and 3) recommend possible solutions or treatments at specific locations along the roadway alignment. Evaluations and recommendations for other features such as cut slopes, subsurface drainage, erosion control, smaller culverts, and on rare occasion storm sewers or other underground utilities may also need to be included during the study, when applicable.

More detailed discussion for analyses, evaluations, and recommendations of roadways is provided in the following:

- [Section 6.3](#) – Subgrades
- [Section 6.4](#) – Embankments
- [Section 6.5](#) – Cut Slopes
- [Section 6.6](#) – Erosion Control
- [Section 6.7](#) – Storm Sewers
- [Section 6.8.2.2](#) – Culverts
- [Section 6.9](#) – Settlement Analyses
- [Section 6.10](#) – Slope Stability Analyses
- [Section 6.12](#) – Seismic Analyses
- [Section 6.14](#) – Construction Details
- [Section 6.15](#) – Special Problems
- [Section 6.16](#) – Contract Documents
- [Section 6.17](#) – Drainage System Filter Requirements
- [Section 6.18](#) – Geosynthetics

6.3 Subgrades

The [Standard Specifications](#) define the subgrade as the top surface of a roadbed upon which the pavement structure and shoulders are constructed. The subgrade must have sufficient strength and stability to support the pavement throughout its design life. This necessitates that subgrade design and construction inspection processes evaluate the uppermost layer(s) of the roadbed. Subgrades are typically comprised of *in situ* (native) and fill soils, chemically modified soils, aggregates, or a combination thereof, to provide sufficient strength and stability for construction and support of the pavement structure.

When evaluating and designing subgrades, there are three main components to consider:

- Pavement design soil parameters,
- Material suitability and stability for constructability and long term performance, and
- Drainage.

6.3.1 Pavement Design Soil Parameters (SSR and IBR)

During a Roadway Geotechnical Study, subgrade soils are evaluated to establish strength parameters used in the pavement design. The soils are evaluated from the top of the proposed subgrade to depths of typically about 30 to 36 inches below.

For pavement design, the Department follows either the Modified AASHTO design procedure or the Mechanistic Pavement Design (MPD) procedure. The Modified AASHTO procedure is based on the AASHTO Road Test Project equations, and it is used to determine pavement structure for continuously reinforced concrete (CRC) pavements, composite pavements, and existing pavement resurfacing. The MPD procedure was developed after the Modified AASHTO for use with more modern construction materials and procedures. It is based on stresses, strains, and deflections to determine the pavement structure for Jointed Plain Concrete Pavement (JPCP), and full depth hot mix asphalt (HMA) concrete pavement. Both of these pavement design methodologies are presented in Chapter 54 of the [BDE Manual](#).

The performance of a pavement is related to the physical properties of the paving materials and of the roadbed soils. The effect of subgrade soil can be reduced by increasing the thickness of the pavement structure. For the MPD procedure, the Subgrade Support Rating (SSR) is used to characterize the subgrade soil. The Modified AASHTO procedure uses the IBR ([Section 5.5.16](#))

to characterize subgrade soil support. Both the SSR and the IBR should be provided for each project, unless the designer has informed the geotechnical engineer that one or the other is not needed.

The SSR and the IBR should be determined from laboratory tests on subgrade samples for most projects. However, where small projects do not warrant testing, both the SSR and the IBR may be estimated from soil properties given for mapped areas in the USDA/NRCS County Soil Reports ([Section 3.2.2.3.2](#)). The SSR and the IBR can be determined from testing the borrow material, if it is known for new embankments, or by selecting a conservative value based on typical soils in the project area. It is common for pavement designers to assume an SSR of “poor” or an IBR of 3 when performing an initial pavement design, and/or until test results are available.

For the MPD, there are three SSR ratings used in the procedure; namely, “poor”, “fair”, and “granular”. The ratings are based on particle size analysis of representative soil samples within the design section. All data should be plotted on the SSR chart, shown on [Figure 7.3.3.5-2](#), and presented in the Roadway Geotechnical Report. The geotechnical engineer shall recommend the SSR rating to the designer, based on the average/majority of data points on [Figure 7.3.3.5-2](#). The SSR ratings on [Figure 7.3.3.5-2](#) are based on a high water table, and appropriate frost penetration in the subgrade soil. The design SSR should be based on the original subgrade soil, and should not be changed to reflect the proposed subgrade improvement.

For the Modified AASHTO procedure, the recommended IBR should represent the “worst” soil type in the proposed pavement length. The geotechnical engineer and designer may investigate the feasibility of changing the pavement structure, in response to changes in either the SSR or the IBR along the proposed improvement. Medium size projects only require one or two IBR tests, once classification tests identify the least favorable soil types in the project area. In the absence of lab data, the approximate IBR value for a soil may be estimated from [Table 6.3.1-1](#), which is Figure 54-3.A of the [BDE Manual](#) reproduced herein.

When MPD procedure is not used, IBR tests should be performed for pavement design. The California Bearing Ratio (CBR) tests are not performed at IDOT, but the CBR values are considered equivalent to the IBR values. (See [Section 5.5.16](#) for differences between CBR and IBR test procedures.)

Soil Classification	Assumed IBR
A-1	20
A-2-4, A-2-5	15
A-2-6, A-2-7	12
A-3	10
A-4, A-5, A-6	3
A-7-5, A-7-6	2

Table 6.3.1-1 Estimated IBR Values

6.3.2 Subgrade Material Suitability and Stability

In addition to determining the pavement design soil parameters discussed in [Section 6.3.1](#), it is necessary to evaluate subgrade soils for material suitability and stability. The Roadway Geotechnical Report shall describe any treatments necessary to provide a stable platform upon which to construct the pavement structure, and which will provide a satisfactory support for the pavement structure throughout its design life. The geotechnical engineer shall evaluate and determine if the subgrade soils are capable of performing adequately for the design period and anticipated traffic loading. Otherwise, remedial treatments should be recommended to assure proper performance. Where high water tables and problem soils will exist at or close to the ground surface, resulting in weak or pumpy soils, it is desirable, where possible, to raise the grade sufficiently in order to provide 24 or 36 in. of suitable material between the problem soil and the subbase. Removal and replacement, as well as stabilization are other possible alternate treatments, but raising the grade offers the better opportunity to provide an improved drainage condition. Unfortunately, project cost or geometric constraints often do not allow raising the grade. The high water table can also be lowered with gravity drains, as an alternative to raising the grade. (Refer to [Section 6.3.4](#) for additional guidance on drainage.)

Design recommendations should consider both **unsuitable** and **unstable** soils. **Unsuitable** soils consist of soils with undesirable properties that should be removed from under a pavement, even if they are stable at the time of construction. Unsuitable soils consist of any of the following: 1) highly organic soils, 2) frost susceptible soils, and/or 3) high shrink/swell potential soils. **Unstable** soils may not be unsuitable, but have a high moisture content and low strength.

The following sub-sections provide information to evaluate subgrade soils for stability and suitability.

6.3.2.1 Stability of Subgrades

When reference is made to the “stability” of soils, the term “stability” is generally applied in two ways. One is regarding overall stability of embankment (or cut) slopes against excessive movement, which is discussed in [Section 6.10](#). The other, which is the topic of this section, refers to the stability of surficial materials, such as subgrades and lifts of compacted embankment fill, against excessive deformation under loading, typically, from construction equipment and traffic. For this later type of stability, unstable deformation behaviors include excessive rutting, pumping, and shoving of a layer of soil or aggregate material under loading.

Subgrade stability must consider the short-term and long-term behavior of the subgrade. The subgrade should adequately support the heavy equipment during construction, with minimum rutting. The subgrade should also support the roadway during its design life. The construction aspects are discussed in [Chapter 8](#) and the [Subgrade Stability Manual](#).

In addition to the subgrade requirements in the [Standard Specifications](#), there are field conditions which must be considered during the life of the pavement structure. The stress level at the subgrade, under repeated peak axle load repetitions, must be maintained within the range of elastic response of the subgrade soil. Failure to do so will result in the yielding of the subgrade, resulting in loss of pavement support and pavement failure.

Internal drainage of the pavement system and the subgrade can exert a profound influence on the pavement performance. As the groundwater rises toward the subgrade, and particularly within the upper 36 in. of a fine grained soil subgrade, the soil is essentially saturated. The result is load support reduction. (Refer to [Section 6.3.4](#) for additional guidance on drainage.)

6.3.2.2 Material Suitability

The type of materials in a subgrade can affect the long term performance of the pavement. Unsuitable soils discussed in [Section 6.3.2](#) are soils with undesirable properties which can be problematic throughout the life of the pavement, even if they are stable at the time of construction. Unsuitable soils consist of any of the following: 1) highly organic soils, 2) frost susceptible soils, and/or 3) high shrink/swell potential soils. Each of these soil types are discussed in further detail along with other materials in the following sub-sections.

6.3.2.2.1 Highly Organic Soils

Highly organic soils are unsuitable for use in subgrades. They are usually unstable and may experience excessive settlement under loading. Deposits of very high organic content soils such as peats and muck can be several feet thick. Treatment of highly organic soils depends greatly on the type and extent of a deposit. Treatment options can range from removal and replacement, bridging with a structure, to other ground improvement methods.

6.3.2.2.2 Suitability of Topsoil

Since Illinois has many areas with little topographic relief, ground skimming grades are quite common and topsoils are encountered. In many projects, the topsoil is undercut and set aside for later use in slope dressing of embankments and/or cut slopes. The [Standard Specifications](#) describe treatment of vegetative cover and the root zone. When the topsoil zone extends well below the shallow root zone, it presents a question regarding its suitability as a material for subgrade, or inclusion in an embankment. Current IDOT practice bases acceptability, for the top 24 in soil, on the criteria listed in [Table 8.4-1](#). These criteria apply to all borrow materials, including topsoil.

Topsoil need not always be removed full depth. Unsuitable topsoil, in the subgrade zone below pavements, should be removed from 12 in. to 36 in. below the bottom of the proposed pavement. The actual depth of topsoil removal depends on the type of roadway and its traffic. Removal of 12 in. would be sufficient beneath secondary roads, with low traffic counts, and little truck traffic. Removal of 24 in. is required for most State highways. Removal of 36 in. is seldom justified, except where there is a great amount of heavy truck traffic, and high compressibility problems. The latter should be verified by consolidation tests, not on estimates using assumed soil parameters.

6.3.2.2.3 Frost Susceptibility and Detrimental Frost Action of Subgrades

A common problem involving fine grained soil and a high groundwater is frost heave and thaw (frost boil). Prolonged cold weather results in deep frost penetration. The presence of high groundwater in a silty soil results in the development of ice lenses. Water moving, by capillarity, from the groundwater surface freezes at the frost line. As this process continues, the frost lenses increase in thickness with time. They consist of pure ice, and may attain a considerable thickness, without inclusion of soil particles.

Ice lenses are the most detrimental frost heave condition. However, there are also frost heave conditions caused by surface water infiltration and freezing. The tenting at pavement joints is caused by freezing water. This tenting often remains after the water thaws, because the repeated freeze-thaw cycles break up the material on both sides of the joint. There may be differential heave between different parts of the pavement, or between the pavements and the shoulder caused by materials with different moisture contents, expanding different amounts.

In spring, the pavement and subgrade thaw from the top down. Water from thawing lenses cannot drain down due to the frozen ground below. This situation is known as frost boil. With non-plastic silt and fine sand soils, the water may cause a complete loss of support, and the failure of the pavement can then be rapid and dramatic.

6.3.2.2.3.1 Frost Susceptibility Evaluation

Frost susceptible materials in the subgrade must be located and defined as to their limits, and remedial measures recommended. Current IDOT practice sets the following criteria to determine frost susceptibility:

- a) The level of capillary rise must be within the depth of frost penetration. This depends on the soil type and water table elevation.
- b) The soil contains at least 65% silt and fine sand, according to AASHTO T 88.
- c) The PI is less than 12.

In general, the frost susceptibility criteria given above corresponds to frost classification F4 used by the Corps of Engineers ([Table 6.3.2.2.3-1](#)). Some estimate of the highest elevation of the water table, and frost potential can be found in the county soil surveys published by the USDA/NRCS.

The depth of frost penetration is another factor to consider in evaluating frost susceptibility. Reliable data on the maximum depth of frost penetration is not generally available. The U.S. Army Corps of Engineers publication [USACE EM 1110-3-138 \(1984\)](#), "Engineering and Design Pavement Criteria for Seasonal Frost Conditions Mobilization Construction", indicates that the maximum depths of penetration under pavement systems, in Illinois, could be expected in the following ranges:

- a) northern one-third, 45 to 60 in.
- b) central one-third, 35 to 45 in.
- c) southern one-third, 25 to 35 in.

It is probable, that the maximum depths would be obtained only during severe winters.

When considering and designing for detrimental frost action, the condition of existing pavements in the project area shall be examined and evaluated. The frost susceptibility criteria, mentioned above, may not always apply to all field and soil conditions. Without careful evaluation of these conditions, the amount of earthwork and cost necessary to prevent detrimental frost action could be very high. If there are existing pavements in the project area with similar soil and drainage characteristics, they should be examined for signs of detrimental frost action.

Longitudinal cracks (other than at longitudinal joints), angled cracks, and curved cracks may indicate frost heave. Tenting of the joints could be a surface problem, and it does not necessarily indicate detrimental frost heave. If existing pavements do not exhibit frost heave problems, and no special treatment was provided to their subgrade soils; expensive treatment may not be justified for the proposed pavement.

Detrimental frost heaving will most likely occur when there is an abrupt change in soil texture. This abrupt change in texture is simple to correct by selective excavation and replacement, if only a few small deposits are involved. In other instances, it may be possible to mix the two soils in order to provide a transition section. Such textural changes occur in going from cut to fill sections, when there is a marked textural difference between the A and B, or B and C horizons of the natural soil. These undesirable changes may be corrected by undercutting at the transition and placement of uniform material over the sharp boundary.

FROST CLASS*	DEGREE OF FROST SUSCEPTIBILITY	TYPE OF SOIL	PERCENTAGE FINER THAN 0.02 mm BY MASS (WEIGHT)	**UNIFIED SOIL CLASSIFICATION SYSTEM
F ₁	Negligible to Low	Gravelly soils	3 to 10	GW, GP, GW-GM, GP-GM
F ₂	Low to Medium	Gravelly soils	10 to 20	GM, GW-GM, GP-GM
		Sands	3 to 15	SW, SP, SM, SW-SM, SP-SM
F ₃	High	Gravelly soils	Greater than 20	GM, GC
		Sands, except very fine silty sands	Greater than 15	SM, SC
		Clays, PI>12	---	CL, CH
F ₄	Very High	All silts	---	ML-MH
		Very fine silty sands	Greater than 15	SM
		Clays, PI<12	---	CL, CL-ML
		Varved clays and other fine grained, banded sediments	---	CL, ML; CL, ML, SM; CL, CH, ML; CL, CH, ML, SM

* After U.S. Army Corps of Engineers
 ** Refer to ASTM D 2487.

Table 6.3.2.2.3-1 Frost Susceptibility Classification of Soils

6.3.2.2.3.2 Detrimental Frost Action Treatments

Subgrade soils should be evaluated for frost susceptibility and potential detrimental frost action discussed in [Section 6.3.2.2.3.1](#) and addressed in the Roadway Geotechnical Report. Common treatments detailed in this sub-section may include:

- 1) deep drains to lower the groundwater surface,
- 2) removal of the frost susceptible soil within the frost danger zone and replacement with acceptable material, or
- 3) raising the grade line.

When pockets of highly susceptible materials (such as, silts and very fine silty sands) are encountered, in the presence of a high water table, these soils may be excavated to a depth that varies, depending on the frost depth anticipated in the project location. The excavated material should be replaced by clayey soils, or other non-frost susceptible materials, preferably from the surrounding area.

If all materials in the area are highly frost susceptible, or there is no readily available source of material of low frost susceptibility, the problem can be solved by raising the grade line above the surrounding area or using an effective underdrain system that lowers the water table and eliminates capillary rise.

Different thermal insulation techniques have been introduced by researchers and manufacturers, but they have not been implemented by IDOT due to lack of sufficient data. These include: 1) the use of a thin layer of shredded tires, 2) expanded or extruded polystyrene (EPS), and 3) light weight bituminized aggregate. The purpose of any of these materials is to provide enough insulation for reducing frost penetration and preventing heat transfer from subgrade to the pavement. The use of an insulating course above the subgrade may be considered, but it is not generally recommended. A drainage layer above the water table may be used, to prevent capillary rise into the frost susceptible soils.

It should be emphasized that detrimental frost heaving is accelerated when there is a readily available supply of water. Thus, even many granular materials are susceptible to detrimental frost heaving, when proper drainage is not maintained. This is particularly apt to be the case in cut sections and care should be taken to eliminate seepage water in the roadway area. This is accomplished with ditches or underdrainage systems.

Another common situation in which detrimental frost heave occurs is when the roadway crosses a culvert. If the depth of overburden on top of the culvert is relatively shallow, freezing may take place from the surface of the roadway. Freezing can take place underneath the roadway from the top of the culvert section. Thus, a greater depth of soil is subjected to freezing over the culvert, than in the adjacent areas. This may be a major cause of the pavement deterioration that frequently is noted over culverts, although improper compaction above and around the culvert section may also be partially responsible. It is probably impossible to completely prevent the deterioration which takes place at culvert crossings, although to a large extent it may be reduced, or perhaps eliminated, by placing adequate cover over the culvert. A minimum depth of soil, plus pavement should be approximately 3 ft. A thicker depth of cover would certainly be desirable in the northern part of the State, in order to ameliorate this unsatisfactory type of behavior. For situations where it is not practical to place a minimum cover of 3 ft. (or thicker) over a culvert, use of well-drained granular material over the culvert should be considered to minimize frost action.

Detrimental frost action due to surface water infiltration should be minimized or prevented by: 1) proper surface grading; 2) pavement and shoulder crack sealing; and 3) good drainage of any water in the subbase material, or under the pavement and stabilized shoulder.

6.3.2.2.4 High Shrink/Swell Potential Soils

Cohesive soils with high clay content and high plasticity may exhibit relatively large volume changes, with changes in moisture content. IDOT has no specific criteria, or test procedure to determine potentially expansive soils, but soils with LL greater than 50 to 60% should be considered suspect. If these soils are present in the subgrade or must be used as embankment under the pavement or shoulder, treatment may be warranted. As with frost susceptible soils, examination of existing pavements in the area may reveal if the high plasticity soils are unstable. Subgrade treatment may consist of surface or subsurface drainage techniques, to prevent moisture changes of the soil; removal and replacement; or treatment with additives (such as, lime) to reduce the plasticity of the material.

6.3.2.2.5 Other Unsuitable/Unstable Soils

Some soils have a natural structure that may become unstable and collapse. These soils are not unsuitable, but their structure may be unstable. Natural loess materials and other slightly cemented soils may have their structure weaken, and collapse when wetted. Placing a pavement over loess causes the soil moisture to increase, and loads may cause the soil structure to

collapse. However, good construction practices usually result in acceptable densification of these subgrade and embankment soils. Unaltered loess materials are often encountered in western Illinois, where the loess thickness could be 15 to 90 ft.

Cohesionless granular soils (sands and gravels) are another material type which can exhibit unstable behavior during construction. In general, granular soils are not unsuitable. However, some may be unstable under construction equipment. Subgrade stability is frequently correlated with a subgrade soil's IBV strength, particularly with cohesive soils. However, cohesionless soils which have mostly rounded shaped particles may be unstable under construction traffic even with higher IBVs. Rounded particles offer less resistance to sliding past each other under traffic loading as compared to crushed particles which exhibit more interlocking. The degree of stability is influenced by the amount of fines, PI, and shape of the granular particles. A couple of treatment options to consider for stabilizing these materials during construction include soil modification (i.e., fly ash or cement) or geosynthetic reinforcement.

6.3.3 Treatment of Subgrade

The stresses and loads applied to the subgrade during construction are almost always higher than the loads reaching the subgrade from traffic on the completed pavement. Nevertheless, the subgrade must maintain its stability, or the life of the pavement will be reduced. In addition, the subgrade must not permit excessive settlement.

6.3.3.1 Treatment Evaluation

Pavements designed according to MPD are required, by the policy, to have a minimum improved subgrade layer 12 in. thick beneath the pavement to ensure a stable working platform. However, the policy requires that granular subgrades be evaluated to determine if treatment is necessary. Also, for cohesive subgrade soils with IBV of 8% or greater, the DGE may request for a waiver of the MPD improved subgrade requirement. Such waiver requires approval of the BDE and the Central Office Geotechnical Engineer at the CBM.

An improved subgrade layer often consists of soil modified with a chemical additive (lime, fly ash, etc.), addition of aggregate, or removal and replacement with aggregate. The improved subgrade provides increased resistance to moisture related problems, reduced rutting, a smooth paving surface, and efficient construction. Subgrade treatment, in addition to the 12 in. improved subgrade, may also be performed, depending on the subsurface soil condition.

In some situations, such as rock cuts and granular soils, the working platform may not be needed. However, in other situations when the IBV is 3% or less ($Q_u < 1$), a 12 in. improved subgrade layer will not provide an adequate working platform. Deviation from the 12 in. working platform shall be documented and presented in the Roadway Geotechnical Report. Soil type, strength, and drainage factor into formulating treatment thickness recommendations. Roadbed soil problems; such as, permanent deformation, excessive volume changes, excessive deflection and rebound, frost susceptibility, and the effect of non-uniform support should be recognized and reported in the Roadway Geotechnical Report. Refer to [Section 8.7](#) and the [Subgrade Stability Manual](#) for additional information.

Pavements designed using the IBR (Modified AASHTO method) are not required to have a minimum 12 in. thick improved subgrade. The geotechnical engineer should determine the actual thickness of treatment, if needed during construction, using the procedure given in [Section 8.7](#).

Design recommendations should consider both unsuitable and unstable soils as discussed in [Section 6.3.2](#) and its sub-sections. Because of their undesirable properties, unsuitable soils should be removed from under a pavement, even if they are stable at the time of construction. However, some soils considered unsuitable for subgrades may be permitted for restricted use at other locations within the project as permitted by the [Standard Specifications](#) and special provisions. Unstable soils may not be unsuitable, but they may have a high moisture content and low strength. In these cases, it may be possible to stabilize these soils with treatment such as moisture conditioning, drainage or use of additives. Consideration to construction constraints such as time, working room, construction staging sequence, economics, material availability, constructability, and project location (urban/rural) should also be factored into formulating design recommendations.

6.3.3.2 Treatment Recommendations

The geotechnical engineer shall present specific subgrade treatment recommendations to the designer. The recommendations shall give the estimated length (usually station to station), recommended width, estimated depth, and recommended type of treatment. The recommendations shall allow the designer to calculate contract quantities. Generalized recommendations, such as providing treatment for a percentage of the project length, are not acceptable. The geotechnical engineer shall explain and justify the recommendations.

Recommendations for the estimated depth(s) are usually referenced to proposed subgrade level (bottom of proposed pavement), but they can be referenced to existing ground surface, or any other point that is clearly defined for the designer. For MPD, the estimated depth of treatment recommendations shall be focused on locations deviating (greater or less) from the 12 in. subgrade improvement thickness required by the pavement design methodology. Where thicknesses are greater than 12 in., only the additional treatment thickness (amount in excess of 12 in.) should be reported in the design recommendations.

The recommendations for type of treatment options include removal and replacement, soil modification including the type(s) of modifier (lime, fly ash, etc.), underdrain installation, or other means. Refer to [Sections 6.3.3.3](#) for discussion on treatment methods, and refer to [Section 6.3.2.2.3.2](#) for additional discussion on treatment of highly frost susceptible soils.

Subgrade recommendations are based on borings typically 300 ft. apart, obtained during weather conditions that may be significantly different from those encountered during construction. Therefore, the geotechnical engineer must use considerable judgment to interpret and analyze the field data, in preparation of the design recommendations. It is usually best, to recommend and design subgrade treatment based on a proper evaluation of field boring data, field site reconnaissance, and experience with other similar projects. As the soil conditions may vary significantly between the soil borings used to estimate a treatment, the recommendations shall include a statement that the actual extent of the treatment shall be determined and either verified or adjusted to the conditions encountered in the field at the time of construction by a qualified soils Inspector.

For additional guidance on reporting subgrade recommendations, refer to [Section 7.3.3.5](#).

6.3.3.3 Treatment Methods

In many instances, the compacted soil will not possess adequate strength and/or stiffness to provide the required stability. Therefore, appropriate remedial procedures must be used. Various treatment methods are presented in this section. They include:

- 1) moisture conditioning and drainage,
- 2) chemical modification/stabilization,
- 3) removal and replacement,
- 4) soil reinforcement, and
- 5) a structure option.

In addition to these methods, raising the grade and/or surface and subsurface drainage practices may also be effective. It is not always apparent, which method should be used for a particular situation. Listed below are guidelines that may be followed to provide adequate consideration of the various treatment methods.

Step 1. Determine subgrade stability requirements for each option:

- Moisture-Density Control – Establish the moisture and density levels required to achieve the needed stability level.
- Use of Additives – Establish the percent of additive and layer thickness required.
- Undercut and Backfill – Determine the required depth of undercut and backfill.

Step 2. Assess potential of each of the procedures by considering the following items:

- Construction variables (equipment, public convenience, time, and compaction).
- Economic evaluation.
- Energy consumption.
- Permanence of treatment.
- Benefit to the performance of the pavement system.

Step 3. Select best option:

- To select the best option, all of the factors should be carefully considered in the comprehensive assessment process. In some situations, certain factors in Step 2 may be weighted more heavily than others, depending on local job circumstances.

Soil type and soil moisture content are the major factors influencing stability. Stability refers to soil strength and deformation properties. For fine grained soils, the moisture content is the primary factor which controls stability. Field soil moisture varies with time and depth.

Subgrade stability requirements are primarily dictated by pavement construction considerations. Analyses of equipment sinkage, due to rutting and paving material compaction operations indicate that a minimum IBV of 6 to 8% is required. Remember that this IBV is not to be confused with the laboratory IBR or CBR used for pavement design. Many typical fine grained Illinois soils do not develop an IBV in excess of 6 to 8%, when compacted at or wet of OMC, according to Illinois Modified AASHTO T 99. Thus, to provide adequate subgrade stability for pavement construction, remedial procedures must frequently be used.

The following sections describe the different treatment methods mentioned above. The discussion of moisture control, removal and replacement, and lime (or other chemical modifier) treatment are summarized from IDOT's [SSM](#). More details can be found in that reference.

6.3.3.3.1 Moisture Conditioning and Drainage

The stability (strength and stiffness) of a cohesive soil is influenced primarily by moisture content and to a lesser extent by density. Wet of optimum moisture is the primary factor influencing stability. For excessively high moisture content conditions, it is difficult to achieve a good working platform for efficient use of construction equipment, and adequate support for the finished pavement.

Disking or tilling, and drying, are generally effective only in the top 8 to 12 in. of subgrade or embankment base, and they are highly dependent on weather conditions during construction. However, drying can be effective if the surface layer of the soil is overly moist. If the soils remain very moist or become wetter with depth, it is difficult to maintain a stable working platform. Field experience and theory indicate that heavy repeated loading of a system, in which a dry soil layer is located above a wet soil layer, will cause a moisture content increase and a reduction in stability of the surface layer. This phenomenon is commonly referred to as "pumping."

If soil is compacted dry of OMC, it may exhibit excellent immediate stability, but it fails to satisfy density requirements. In time, should this material approach saturation, the strength could significantly be reduced. When there is a shallow groundwater elevation, the dried subgrade will

regain moisture, once covered by pavement or fill material. The significance of the loss of stability of a subgrade, as the moisture level rises, depends on the pavement design.

Soils that drain rapidly, or relatively rapidly, may be stabilized by the installation of pipe underdrains, as early as possible, during subgrade preparation. Pipe underdrains could maintain the stability of soils that have been disked or tilled, and dried.

6.3.3.3.2 Use of Additives

Economy requires that quality natural aggregates be used as sparingly as possible, in meeting the needs of the high quality highway pavements in Illinois. In many parts of the State, quality natural materials are not locally available, and must be transported long distances at considerable cost. In the construction of satisfactory highway pavements, economy may be achieved through the use of additives that can change the characteristics of the subgrade soil, and thus require lesser pavement thicknesses. Additives may also be utilized to upgrade the characteristics of low quality natural aggregates.

In addition to economy, there are several advantages to soil-additive treatment.

- 1) Subgrade undercutting is minimized. In most cases, the required depth of stabilization can be achieved without removing any of the *in situ* material.
- 2) If wet borrow materials are encountered, the lime treatment operation is incorporated as part of the layer by layer embankment construction sequence. Normally, the percent lime used as a drying agent is significantly less than that used for lime modification.
- 3) Compared to the removal and replacement with granular backfill, lime treatment is more cost effective.

There are numerous stabilizing agents available that can be used in pavement construction. In general, stabilizing agents may be divided into two broad categories based on the stabilization mechanisms: active agents and inert agents.

Active stabilizers produce a chemical reaction with the soil or aggregate, which in turn produces desirable changes in engineering characteristics of the soil or aggregate stabilizer system. A prime example of an active stabilizer is lime. When lime is incorporated in medium to fine grained soils it produces numerous favorable reactions.

Conversely, inert stabilizers do not react chemically with the soil or aggregate, but rather act to bind together the natural materials. Bituminous material is an example of this type of stabilizer. Other inert stabilizers in common use are Portland cement, and lime-fly ash mixtures. In general, active stabilizers are most efficient and economical with fine textured soils; whereas, inert stabilizers ordinarily find their greatest application with coarse-textured soils. However, Portland cement may be quite satisfactory and economical with coarse-textured soils, as well as medium to moderately fine-textured soils.

Lime is often used as a drying agent during construction or to provide a stable working platform (lime modification). It may also be used to permanently improve the subgrade material and become a part of the pavement structure (lime stabilization). Portland cement and bituminous material may also serve as additives for strengthening a subgrade. However, these two, and especially bituminous, are most effective in relatively cohesionless soils containing significant sand or gravel quantities.

Other soil-treatment procedures may also improve the strength and deformation properties of wet, fine grained soils of inadequate stability. These include Portland blast-furnace slag cement, by-product non-hydrated lime (lime kiln dust), by-product hydrated lime (hydrator tailings), and Class C fly ash. Selection of the type of additive(s) depends upon the soil's reactivity or compatibility with the additive(s). A complete analysis of the strength and stiffness modifications, curing requirements, thickness requirements, and permanency of treatment should be conducted, to evaluate the effectiveness of the stabilizing agent. For these additives the same general construction procedures are used as for lime. Refer to [Section 5.6.1](#) for discussion soil type and additive mixture compatibility, and refer to [Section 6.3.3.3.2.4](#) for additional considerations in evaluating and developing design recommendations.

Soil stabilization technology has been an area of avid research for many years. Nevertheless, many of the tests and techniques used to evaluate stabilizers, or to judge the amount of stabilizer necessary to provide the stability and durability required for a given soil are not standard laboratory procedures. The reader is referred to the publication titled "Soil Stabilization in Pavement Structures: A User's Manual", Terrel et al. (1979); and to Publication No. FHWA-IP-80-2, Vols. 1 and 2, for a thorough discussion, and a significant list of references on stabilizer techniques most appropriate for Illinois soils. Also, see the [Subgrade Stability Manual](#) (2005). Mix design procedures used by the Department are provided in [Appendix B](#), and are discussed in [Section 5.6](#).

There are three primary applications for using additives:

- Drying agent,
- Soil Modification, and
- Soil Stabilization.

6.3.3.3.2.1 Drying Agent

Even though the subgrade materials may be judged acceptable, the physical condition in the field may be so soft and wet as to prevent construction activities. If the soil cannot be dried out by aeration within a reasonable time, consideration should be given to treatment with an additive to increase its stability. Lime is the most used additive by IDOT for such situations. Lime may be added to dry up the soil, for construction expedience. Using additives as drying agents is typically performed at the option of a contractor during construction and is not an application used for design recommendations.

6.3.3.3.2.2 Soil Modification

Soil Modification is used as a subgrade improvement option to provide a working platform for construction activities. Usage of soil modification as a treatment option depends on the pavement design methodology. There are a number of chemicals additives available for soil modification. The mix design process and a list of common soil modification agents are referenced in [Section 5.6.1](#). Additional information on material, construction and strength criteria is located in the [Standard Specifications](#), and [Section 6.3.3.3.2.4](#) provides further discussion on evaluating and developing design recommendations.

6.3.3.3.2.3 Soil Stabilization

Soil stabilization is similar to soil modification, except that it requires higher strength, more durable mixes used in subbase and base course applications. Usage of soil stabilization as an option depends on the pavement design methodology. Soil stabilization mixtures include lime stabilization, soil-cement, cement aggregate mixtures, and pozzolanic mixtures (cement or hydrated lime with fly ash). The cement aggregate mixtures and pozzolanic mixtures are in the process of being phased out of the [Standard Specifications](#). Once they are phase out, their use will require a special provision and approval by the CBM. Refer to [Section 5.6.2](#) for discussion on soil stabilization mix designs, and refer to the [Standard Specifications](#) for material, construction

and strength criteria. Additionally, [Section 6.3.3.3.2.4](#) provides discussion on evaluating and developing design recommendations.

One application of soil stabilization is a lime stabilized soil mixture used as a base course in the pavement. In this case, the soil shall be a reactive soil, according to the [Standard Specifications](#). This means that the mixture should have a compressive strength increase greater than 50 psi, and a minimum total compressive strength of 100 psi. If these conditions are satisfied, [Table 6.3.3.3.2.3-1](#) should be used to determine the layer thickness. It is important to allow adequate field curing time, to develop the mixture compressive strengths required.

In Situ Subgrade Strength				Minimum Lime-Soil Layer	
k** (psi/in.)	Q _u (tsf)	IBR %	Cone Index***	Thickness (in.) ⁽¹⁾	
				100 psi ⁽²⁾	200 psi ⁽²⁾
50	0.6	2	80	12	9
125	1.2	4	160	12	9
150	2.0	6	240	9	8
200	2.5	8	320	9	8

* Data reproduced from the [SSM](#).
 ** Modulus of Subgrade Reaction.
 *** Penetrometer load in lbs. divided by the cone base area in.². Units in psi not expressed.
 (1) Required strengths must be developed in stabilized layer, before layer is opened to traffic.
 (2) Q_u values for the lime-soil mixture.

Table 6.3.3.3.2.3-1 Thickness Requirements for Lime Stabilized Soil Layers *

6.3.3.3.2.4 Mix Design Evaluation and Recommendations

For both soil modification and stabilization treatments, selection of the type of additive(s) depends upon the soil’s reactivity or compatibility with the additive(s). For example, a soil requires a minimum clay content to react with lime. Additive options depend largely on the type of subgrade soils. Laboratory index tests of the project soils such as grain size analysis, Atterberg limits, and organic content can be used to identify the type(s) of additive(s) that should be compatible with the soil(s). These index tests should be performed for each soil type encountered for subgrade soils located at-grade, in cut sections, or sourced for fill from on-site excavations to aid in the additive selection. Subgrade soils (and their properties) in fill sections made up of off-site soils are typically not known until construction, unless the source of subgrade soil is identified at the

time of design. If needed, the properties of fill materials may be restricted in the contract documents to satisfy specific soil treatment requirements determined during design.

Mix designs are typically formulated during construction. This is because the source of the additive and borrow/furnished excavation soils are not known until a project is under contract for construction. Once construction is underway, the [Standard Specifications](#) call for representative samples of soil (or aggregate) and chemical additive(s) to be provided to the Engineer for performing the mix design(s). When soil modification or stabilization mix designs are to be performed during the construction phase, the Roadway Geotechnical Report should include an estimate of the proportion(s) of the additive(s) to mix with soil(s) and water for quantity estimates.

Occasionally, the soil properties and the additive source(s) for a project are known in the design phase. For these instances, the mix design data should be reported in the Roadway Geotechnical Report for inclusion in the construction documents. This includes information such as moisture-density (Proctor) curves for the various percentages of additive(s), strength gain data, and the optimum proportion(s) of the additive(s) to mix with soil(s) and water for quantity estimates.

When evaluating treatment depths, it should be noted that due to practical limitations of mixing and compaction processes the maximum depth of treatment in a single lift/layer is approximately 14 inches. If a deeper treatment is required, multiple lifts of treatment will generally be needed, or a combination of treatments may be specified. An example of a combined treatment is employing 12 inches of modified soil with a 6 inch compacted crushed aggregate layer on top.

6.3.3.3.3 Removal and Replacement (or Undercut and Backfill)

Removal of the weak subgrade soil and replacement with a more suitable material is another remedial alternative. When settlement is not a problem, relatively shallow undercuts may be used to provide a working platform, or stable subgrade. Deep deposits of peat and muck usually require extensive removal and replacement to prevent or mitigate settlement.

A popular remedial procedure is to cover a soft subgrade with a layer of granular material. Another procedure is to remove a portion of the soft material to a predetermined depth below the PGL and replace it with granular material. The granular layer distributes the wheel loads over a larger area of the unstable subgrade and serves as a working platform on which construction equipment can operate.

[Section 8.7](#) presents a simple procedure for determining the thickness of removal and replacement.

The removal and replacement method for providing a stable working platform is mostly used in urban areas, where lime (or other additive) treatment could be too dusty. This method may also be preferable due to other construction considerations including time constraints, weather, quantity is small, and/or limited working room such as a narrow widening width. Several advantages have contributed to its popularity, including:

- 1) This method is a simple procedure which does not require any specialized equipment. All of the equipment needed for the operation is normally present on a highway construction project.
- 2) The method can be used for large scale treatments and for spot treatments.
- 3) If suitable backfill material is readily available, the undercut and backfill treatment is relatively inexpensive. The costs involve excavating and wasting the unsuitable material and procuring, placing, and compacting the backfill material. As the distance to the source of backfill material increases, the cost will increase.
- 4) It is possible, with reasonable results in most circumstances, to design for a specified number of coverages using an IBR based design.

Several problems are involved in the use of removal and replacement as a remedial measure. These include:

- 1) The IBR based design method may not always be adequate for determining the proper required thickness of undercut and backfill. The procedure is empirical and has been extrapolated for a design situation different from which it was developed.
- 2) If the subgrade is of poor quality due to a high water table, the backfill material may also be affected by the water conditions. In this case, it is necessary for the strength of the backfill materials to be fairly insensitive to moisture content increases.
- 3) Unless a separation layer is used, the weak subgrade may infiltrate into the granular material or the granular material may intrude into the soft soil, thereby reducing the effective thickness of the granular layer.

In some cases, surface and subsurface drainage techniques may be effectively utilized to alleviate moisture related problems, noted in Items 2 and 3 above.

6.3.3.3.4 Soil Reinforcement

The stability of soft subgrades can be increased by placing a geosynthetic material (fabric or grid) over the soft subgrade and covering it with granular material. The basic functions of the fabric are: 1) to keep the subgrade soil separated from the granular material; 2) to aid in distributing the stresses transmitted to the subgrade; and 3) to provide a filter medium which allows water to flow from the subgrade to the granular layer, thereby providing a drainage path for the subgrade soil.

As a separator, the geosynthetic prevents the intrusion of soil fines into the subbase voids; or the loss of aggregate material from the subbase, due to sinkage into the subgrade. Care must be taken when selecting the type of separation. Moisture migration between the granular material and the underlying soil may be necessary.

Reinforcement with geosynthetics is another option available for improving the support capacity of subgrades. Geosynthetics introduce a tensile characteristic to the pavement support system. The geosynthetic distributes the load over a greater area of the interface between the subbase and subgrade. However, reinforcement has not been used to reduce the pavement thickness. The concept has only been used to reduce the thickness of granular material needed to provide a stable construction platform. Research and experience have shown the granular thickness may

be reduced by approximately a one-fourth to one-third, by placing a suitable geosynthetic at the granular-soil interface. Several factors, including subgrade strength, traffic coverage, and geotextile properties, influence the thickness of the granular layer required.

For subgrade treatment applications, refer to the [SSM](#) for guidance on treatment thickness using geosynthetics. Additionally, [Holtz et al. \(1998\)](#) and several geosynthetic manufacturers have developed granular layer thickness design methods. To determine the actual thickness of granular material over the geosynthetic, for a specific project, refer to [Holtz et al. \(1998\)](#), or to [Koerner \(1990\)](#). Both references provide step-by-step methods for determining the granular cover on a geosynthetic. When using a geosynthetic for this purpose, a minimum of 6 in. of granular cover is desirable before exposure to vehicular traffic. For projects using design methods other than the [SSM](#), the CBM should be contacted and will use the most reliable method.

Design Considerations

In general, geosynthetics should only be considered when the IBV is 3% or less. Refer to the [SSM](#) for guidance on treatment thickness using both geotextiles and geogrids. To determine the granular thickness, without a geosynthetic, see [Section 8.7](#).

The decision of whether or not to employ a geosynthetic should be made on the basis of economics, which may vary significantly between projects. A reduction in the required granular layer thickness also means a reduction in depth of undercutting, if required. The geotechnical engineer must determine whether the geosynthetic and installation costs are less than the extra excavation and aggregate costs.

When employing a geotextile or geogrid to carry tensile stresses, it may prove beneficial to use materials with a moderate to high modulus. A single overload application may cause the low modulus material to fail with deep rutting of the granular subbase. A high modulus material will preclude deep rutting of the granular subbase. While the granular subbase may sustain moderate rutting, costly repairs can be avoided.

The [Standard Specifications](#) indicate the minimum requirements of fabrics for ground stabilization. While these specifications are applicable to many project conditions, there may also be other projects that require different geotextile properties. If a fabric is required that is different from the [Standard Specifications](#) or a geogrid is required, the Roadway Geotechnical Report must contain a project specific Special Provision.

6.3.3.3.5 Structure Option

When the roadway subgrade over a peat bog cannot be stabilized satisfactorily by any of the above options, a dry land bridge may be proposed. A dry land bridge is an expensive option, but it provides a very stable roadway. A dry land bridge should not be selected based on initial cost. The extra maintenance costs and future replacement costs must also be considered. In the northern part of the State, dry land bridges are subject to icing.

The design recommendations must specify the bridge length (may be different for different lanes), the pile lengths, and any design details. An example of a design detail is the support of the storm sewer, if a closed drainage system is part of the improvement.

6.3.4 Pavement Drainage

Proper drainage is integral to the performance of pavements and the underlying subgrades. Pavement drainage is facilitated through a variety of features including the pavement cross-slope, vertical profile (elevation above water table), ditches, curb and gutters, storm sewers, and subdrains. The geotechnical study must consider the several factors such as soil type, water table, roadway profile, pavement/subgrade composition, and proposed pavement drainage features the evaluation process to develop recommendations.

6.3.4.1 Drainage Classes

During the geotechnical study, drainage conditions should be described according to one of four drainage classes. These depend on the soil type, the profile grade line, and the depth and grade of ditch, as summarized in [Table 6.3.4.1-1](#). The geotechnical study shall indicate the worst drainage conditions that exist for design purposes. (See [Section 7.3.3.5](#) for reporting guidance.)

The drainage classification cannot be determined on the basis of soil test results alone, since good drainage can exist with clays, silty clays, or organic soils. The degree that detrimental properties may develop will depend upon drainage conditions, as indicated by the topography; and the entire soil profile. If the water table is high, good drainage does not exist in sandy soils. The elevation of the water table could significantly impact frost action (See [Section 6.3.2.2.3](#)). Therefore, the drainage class should consider frost action. According to [Table 6.3.4.1-1](#), the four drainage classes are:

- a) Good Drainage
 - 1) The temporary or permanent water table is low enough that the underlying soil will not become saturated from capillarity, and
 - 2) the topography allows surface water to be removed rapidly without saturating the underlying soil from above, and
 - 3) there are no internal drainage characteristics or other conditions which will produce saturation or instability of the underlying soil.
- b) Fair Drainage
 - 1) There is a possibility of a high temporary water table, but the permanent water table is low, and/or
 - 2) there is a possibility of surface water not draining off rapidly, due to the topography, but
 - 3) there are no internal drainage characteristics or other conditions which will produce saturation or instability of the underlying soil.
- c) Poor Drainage
 - 1) The temporary water table will be high, but the permanent water table is low, and/or
 - 2) surface water will not drain off rapidly, due to the topography, and/or
 - 3) there is a possibility of internal drainage characteristics or other causes which may result in saturation or instability of the underlying soil.
- d) Very Poor Drainage
 - 1) The permanent water table is high, and/or
 - 2) the surface water will not drain off rapidly, due to the topography, and
 - 3) there are internal drainage characteristics or other causes which will produce saturation or instability of the underlying soil.

PROFILE	SOIL TYPE				MOISTURE CONDITION	CLASSIFICATION											
	Less than 3 ft. of Fill to Less than 6 ft. of Cut	6 ft. or Greater Cut	A-4	A-7-6 (15) to (20)			A-7-6 Less Than (15) or A-6	Fine Sand or Sandy Soil	Gravel and/or Coarse Sand								
CROSS SECTION	Ditch 3 ft. or Deeper	Shallow Ditch or Gutter	Less than 0.5%	0.5% or Greater	Dry	Very Poor	Fair	Good									
						Ditch 3 ft. or Deeper			Shallow Ditch or Gutter	Less Than 0.5%	0.5% or Greater	Moist	Poor				
													Shallow Ditch or Gutter	Less Than 0.5%	0.5% or Greater	Wet	Poor
																	Ditch 3 ft. or Deeper
	Ditch 3 ft. or Deeper	Shallow Ditch or Gutter	Less Than 0.5%	0.5% or Greater	High Water Table		Very Poor										
						Ditch 3 ft. or Deeper	Shallow Ditch or Gutter	Less Than 0.5%	0.5% or Greater	Dry	Very Poor						
											Ditch 3 ft. or Deeper	Shallow Ditch or Gutter	Less Than 0.5%	0.5% or Greater	Moist	Very Poor	
																Ditch 3 ft. or Deeper	Shallow Ditch or Gutter
	Ditch 3 ft. or Deeper	Shallow Ditch or Gutter	Less Than 0.5%	0.5% or Greater	Very Wet												
						Ditch 3 ft. or Deeper	Shallow Ditch or Gutter	Less Than 0.5%	0.5% or Greater	High Water Table							
											Ditch 3 ft. or Deeper	Shallow Ditch or Gutter	Less Than 0.5%	0.5% or Greater	Dry		
																Ditch 3 ft. or Deeper	Shallow Ditch or Gutter
	Ditch 3 ft. or Deeper	Shallow Ditch or Gutter	Less Than 0.5%	0.5% or Greater	Wet												
						Ditch 3 ft. or Deeper	Shallow Ditch or Gutter	Less Than 0.5%	0.5% or Greater	Very Wet							
											Ditch 3 ft. or Deeper	Shallow Ditch or Gutter	Less Than 0.5%	0.5% or Greater	High Water Table		
																Ditch 3 ft. or Deeper	Shallow Ditch or Gutter
Ditch 3 ft. or Deeper	Shallow Ditch or Gutter	Less Than 0.5%	0.5% or Greater	Moist	Very Poor												
					Ditch 3 ft. or Deeper	Shallow Ditch or Gutter	Less Than 0.5%	0.5% or Greater	Wet	Very Poor							
										Ditch 3 ft. or Deeper	Shallow Ditch or Gutter	Less Than 0.5%	0.5% or Greater	Very Wet	Very Poor		
															Ditch 3 ft. or Deeper	Shallow Ditch or Gutter	Less Than 0.5%

Fill greater than 3 ft. are classed as good drainage. Moisture rating should be adjusted if other than normal rainfall precedes survey.

(Reproduced from Design Memorandum No. DM 95-8).

Table 6.3.4.1-1 Drainage Classification

6.3.4.2 Drainage Systems and Filters for the Pavement Structure

It has been demonstrated by field study and research, that the pavement system frequently becomes saturated following periods of precipitation, primarily by roof leakage. When the pavement system is subjected to repetitive loading by vehicular traffic, the pavement deflections result in subsequent momentary increases in pore pressures within the subgrade soil, the subbase, and base courses. Historically, rigid pavements built directly on tight clay subgrades, and subjected to heavy traffic have undergone pumping. The pumping causes groundwater and suspended soil fines to be ejected from under the pavement. Early efforts to preclude this pumping, by building the pavement on a dense graded granular subbase (such as CA 6), seemed to meet with initial success, but eventually were damaged by pumping.

Longitudinal edge drain systems have gained popularity, but do not provide the complete answer. Studies showed that pulse loading on a concrete slab caused high pore pressures in the underlying CA 6 material. The pore pressures resulted in water velocities as high as 20 feet per second (fps). The same pulse loading on a pavement founded on submerged, coarse, open graded aggregate (uniform granular material such as CA 7) for concrete reduced the velocities to about 6 fps. These velocities will only be valid for a very short distance, but at 20 fps the fines in the CA 6 will be ejected through the pavement joints and cracks. This would result in significant reduction in the pavement support, and ultimately pavement failure. Ideally, the base or subbase should be graded to drain water fast. Thus, the velocities will not be sufficient to cause loss of fines.

Moisture movement within the pavement system must consider the interfaces between the pavement, base, subbase, and subgrade. Test track studies, at the University of Illinois, demonstrated that a pavement on open graded aggregate base, over a clay subgrade, was damaged by intrusion of soil fines into voids of the open graded aggregate base. The situation was not improved by placing a geotextile between the subgrade and the base. Performance was not improved even when the open graded aggregate base was placed on a subgrade stabilized with hydrated lime. Due to the problems of constructing a pavement on an open graded aggregate base, consult with the CBM for current practices.

The purpose of an edge drain system is to drain water from under the pavement. Edge drains are not intended to reduce the moisture content of the subgrade soil. Field studies showed that the moisture content of subgrade soils remained at the saturation level all year round. This occurred for pavements with and without edge drains, and for all types of subbase materials. If

granular materials will be used under the pavement, they must allow water movement, without loss of particles from the granular layer, or of soil fines from below. Therefore, the edge drain system must readily facilitate the flow of water, but not allow filter material to enter. Refer to [Section 6.17](#) for information on filtration design requirements.

6.3.4.3 Subsurface Drainage Design Considerations

Since it is desirable to maintain the pavement system and subgrade free of excess water, subdrains are frequently employed. Drainage must provide for the dissipation of water, accumulated in the pavement structure, due to roof leakage. In certain localized areas, drainage also must be provided for seepage water entering the pavement subgrade system laterally, or from below the subgrade. The [Standard Specifications](#) and [Supplemental Specifications and Recurring Special Provisions](#) contain different types of pipe drains, pipe underdrains, French drains, and backslope drains ([Section 6.5.2.2](#)). Additionally, [Highway Standard](#) 601001 contains standard details on various subsurface drains. The design recommendations must specify the exact type of drain to be used. Systems should meet filtration design criteria discussed in [Section 6.17](#) to facilitate flow of water without migration of fines as discussed in [Section 6.3.4.2](#).

Various geosynthetic products have gained favor as a substitute for conventional soil filters, and they offer an excellent opportunity to provide a satisfactory filter system at a considerable cost savings. Geotextile filter fabric can be designed by methods similar to that for aggregate filters. Geotextile filters are much more economical than aggregate filters. Fabrics or drainage materials specified in the [Standard Specifications](#) should be used, if possible. If another fabric must be used, a project specific Special Provision addressing material properties, storage, handling, and installation must be provided to the designer.

Longitudinal edge drains installed along pavements are the most common subdrain system for pavements. Since these systems are gravity drains, design plans should be detailed to identify longitudinal edge drains beginning at high points and outletting at low points along the roadway profile. Where unstable or unsuitable soils are to be removed (undercut) and replaced with aggregate, the underdrains should be lowered such that water is accepted from the lowest point of an undercut and outletted accordingly. When necessary, lateral or herring bone (diagonal) patterned subdrains can also be used beneath pavements. This is done to speed up the conveyance of water. Examples of such lateral subdrains applications include: 1) at sag/cut locations along the vertical profile where there is no positive surface outlet and 2) at locations with groundwater seepage (springs) under the pavement.

A recent addition to the [Standard Specifications](#) for pipe underdrains is called Pipe Underdrains, Type 3. It is the result of research conducted by the University of Illinois for IDOT to identify an optimal aggregate gradation and slot size in the perforated underdrain pipe in order to improve drainage flow while minimizing pipe clogging and loss of fines from the trench sidewalls. The research report [IHR-R25](#) by [Stein and Dempsey \(2004\)](#) indicated the perforated corrugated PE pipe should meet the requirements of AASHTO M 252-96 except that it should have a slot width of 0.07 ± 0.01 inches. In addition, the number of slots and slot length may be modified to maintain the inlet flow specified in AASHTO M 252-96. Finally, the research indicated that fabric should not be used around the pipe.

From this study, it was determined that the optimal backfill material for this design should meet the requirements of Section 1003 of the [Standard Specifications](#) for an FA 4 natural sand and satisfy the following gradation requirements:

<u>Sieve Size</u>	<u>Percent Passing</u>
3/8 inch	100
No. 10	10±10
No. 16	5±5
No. 200	1±1

This gradation is the FA 4 Modified (Option 1) material in Article 1003.01(c) of the [Standard Specifications](#) for use with Pipe Underdrains, Type 3. Use of this gradation depends on its availability in some regions. However, it is recommended that DGEs specify the use of this material when available.

Pipe underdrains and their outlets can become clogged with grass cuttings, rodent dens, or be crushed by mowing tractors throughout their operational life. As a consequence, they should be inspected on a regular basis and maintained as needed in order to ensure proper conveyance of water for their operational life. If there are existing pipe underdrains or other subdrain systems within the limits of a proposed improvement, they should be evaluated and recommendations provided for any treatment (repair, removal, replacement, relocation, or remaining in-place, etc.).

6.4 Embankments

Embankment design recommendations should address settlement, slope stability, and the bearing capacity at the base. Any special design requirements for embankments shall be addressed in the Geotechnical Report. When applicable, the design recommendations should also discuss any potential impacts of stability and settlement on proposed construction staging and schedule. When excessive settlement or stability becomes a concern, remedial treatments should be considered.

The embankment settlement must be tolerable, especially adjacent to rigid structures. Differential settlement is more of a concern than the total settlement. In the absence of bridges and culverts, the “tolerable settlement” depends primarily on the rideability of the roadway, rather than the structural integrity of the pavement. At bridge approaches and culvert crossings, the tolerable settlement depends on both the rideability and the structural integrity of the bridge or the culvert.

The stability of slopes is discussed in [Section 6.10](#), and IDOT’s current practice requires a minimum **FOS of 1.3** against a slope or base failure if the analysis is based on laboratory testing of intact (relatively undisturbed) samples. If the stability analysis is based on the field (Rimac) tests of split-spoon samples, the **FOS should be 1.5**.

6.4.1 Embankment Material Properties

Embankment fill material properties may not be known until a borrow source is identified during construction. As such, the following material property assumptions for proposed fill are used for embankment settlement and slope stability analysis:

- Assume new embankment fill to be cohesive with a Q_u of 1.0 tsf
- Assume a moist unit weight of new embankment fill, $\gamma = 125$ pcf

Any variance from using these assumed material properties for embankment settlement and slope stability analyses shall be documented in the Geotechnical Report along with the reasoning for the deviation.

Locations with significant quantities of Earth Excavation material within the project limits should be sampled, tested and evaluated for reuse within the project limits. The Geotechnical Report should include recommendations for utilization of this material identifying if it is suitable/unsuitable or restricted use and include estimated extent of material that is either unsuitable or restricted.

Some soil types identified in [Sections 6.3.2](#) and [6.3.2.2](#) as unsuitable soil for use in subgrades may be suitable for restricted use in the core of an embankment. These include some frost susceptible and high shrink/swell potential soils. Soils with high potential for erodibility should also be restricted to the embankment core. These restricted soils are then capped with “unrestricted” earth material which functions as a protective layer against erosion, freeze-thaw, and shrink-swell effects.

Guidance on standard embankment construction practices can be found in Section 205 of the [Standard Specifications](#), District Special Provisions, and [Section 8.3](#) of this Manual. Additional information on borrow and excavation materials requirements is available in [Section 8.4](#). However, District Special Provisions should also be referenced for additional regional material requirements.

6.4.2 Embankment Settlement

Embankments constructed over compressible deposits experience settlements that vary in degree of severity and the length of time to reach equilibrium. Laboratory consolidation tests on intact (relatively undisturbed) samples will give an estimate of the amount of settlement and the time required to achieve the settlement. Refer to [Section 6.9](#) for guidance on performing settlement analyses and conducting preliminary assessments to identify when settlement is a concern. The stresses in embankment foundation soils may be estimated by procedures discussed in [Appendix D](#).

When it is necessary to achieve a tolerable amount of settlement before proceeding with further construction activities, the Geotechnical Report should describe the situation and present recommendations on various available treatments. The treatment methods should provide the designer with an opportunity to compare the economics of each, and to estimate the time required to achieve the greater part of the settlement, by each method. Each treatment method should be accompanied with backup data, to help the designer compare the alternatives.

The geotechnical recommendations shall include magnitude of estimated settlement and estimated waiting period(s) both with and without any remedial treatments. Laboratory consolidation test data is required to estimate the settlement time(s). Typically, the time required to achieve 50% and 90% (t_{50} and t_{90}) of the total estimated primary settlement is included with settlement plate and various other special provisions and plan details, as applicable.

Some of the corrective measures IDOT has used to mitigate settlement problems are:

- Removal and replacement of the compressible soil. The economics of this method have to be questioned, when the depth of removal exceeds 12 ft.
- The use of instrumentation and time delays in bridge foundations and approach pavement construction, until an acceptable level of consolidation has taken place.
- The use of sand or wick drains, mostly in conjunction with preloading, to accelerate settlement.
- Preloading the site with a surcharge load.
- Vibrocompaction. This treatment applies to loose, granular deposits only.
- Dynamic compaction. This consists of dropping a weight from a certain height to densify the upper 15 to 20 ft. of loose, granular deposits.
- Aggregate (Stone) Columns. This is the partial replacement of soft, weak *in situ* soil with compacted vertical columns of aggregate.

For additional discussion on these remedial treatments, refer to [Section 6.4.4](#).

On occasion the Department will issue a grading contract to perform earthwork, typically on a new alignment, in advance of a separate contract to construct the pavement and/or structures. These grading contracts may offer a benefit of increasing the length of the time available for the settlement period. Depending on the amount of time between contracts, this additional time may be used to minimize the need for more extensive treatment and reduce the cost of a project.

6.4.3 Embankment Stability

As discussed in [Section 6.3.2.1](#), the term “stability” is generally applied in two ways. This section primarily focuses on evaluation and treatment for slope stability of an embankment. However, for construction purposes, the second stability type to evaluate pertains to the behavior of surficial soil at an embankment base.

Similar to subgrade stability discussed in [Section 6.3.2.1](#), treatment of soils encountered at or near the surface of the existing ground may be needed in order to establish a stable base to facilitate embankment construction. This is for cases where the base requires some remediation against excessive deformation under construction equipment and provide sufficient support for compaction of embankment material in order to achieve the required density (which varies depending on the proposed height of embankment), strength, and stability of the fill material. The techniques used to improve the stability of the base of an embankment are essentially the same as those used to improve the stability of a subgrade, as discussed in detail in [Section 6.3.3](#), and will not be repeated in detail in this section. The recommended treatment type and estimated extent (length, width, and depth) shall be included in the Geotechnical Report similar to that of subgrades ([Section 7.3.3.5](#)).

As mentioned previously in [Section 3.4.2](#), embankments with fill heights greater than or equal to 15 ft. will require slope stability analysis. IDOT’s current practice utilizes a minimum **FOS of 1.3** for embankments, based on **laboratory testing** of intact (relatively undisturbed) samples. If the stability analysis is based on the **field (Rimac) tests** of split-spoon samples, the **FOS should be 1.5** or greater. Refer to [Section 6.10](#) for guidance on performing slope stability analyses and conducting preliminary assessments to identify when slope stability is a concern to be evaluated.

In order to satisfy or exceed the minimum FOS requirements for slope stability, remedial treatments are employed. The particular treatment used should be selected on the basis of economics and possible site constraints. The techniques suggested below are not listed in any order of priority, importance, or cost, but must be selected to best fit a particular situation. In general, deficiencies in slope stability FOS can be corrected by any one of several measures, such as:

- Removal and replacement of the weak material.
- Adjustment of embankment geometry including slope flattening and employment of a midslope berm, or other variations of berms.
- Soil reinforcement with steel, geogrid, or geotextile.
- Installation of wick drains, sand drains, or aggregate columns.
- Instrumentation and control of embankment construction.
- Installation of a structural support such as a retaining wall; or a dry land bridge over weak foundation soils, to avoid base failure.

The method chosen should be feasible, economical, and suited to the site conditions. The chosen method should be analyzed to demonstrate its capability of improving the FOS to meet minimum requirements.

Both significant primary and secondary settlements as well as low FOS for slope stability can occur where embankments are placed over highly organic deposits, such as peat bogs. For peat bog remediation, several removal and replacement techniques are presented in [Section 6.4.4.2](#). However, structural support such as a dry land bridge and other treatments may need to be considered depending on the economics, time, and other factors.

6.4.4 Remedial Treatments

Remedial treatments for embankment construction are performed predominately to mitigate one or more of the following:

- Magnitude of total and/or differential settlement
- Time duration for completion of primary settlement
- Slope stability FOS

When the duration and/or magnitude of settlement is/are deemed unacceptable and/or the minimum FOS cannot be achieved for slope stability, the geotechnical engineer should provide remedial treatment recommendations. The following sub-sections discuss treatment options that are common for settlement and/or slope stability as presented in [Sections 6.4.2](#) and [6.4.3](#), respectively. Remedial treatments are often used in combination, such as wick drains with a surcharge, in order to achieve desired results.

Each remedial treatments option has an economic and construction schedule impact that varies in magnitude and should be evaluated such that the most appropriate one(s) is/are selected. Design of these treatments requires adequate field and laboratory test data in order to perform analyses and provide economical recommendations. With the exception of the remedial treatments for granular deposits listed in [Section 6.4.2](#), Shelby tube borings with consolidation, triaxial and other associated tests for each stratum are required for performing analyses and developing remedial treatment recommendations.

When remedial treatments are recommended, the geotechnical engineer shall present specific remedial treatment recommendations to the designer and explain and justify the recommendations. The recommendations in the Geotechnical Report shall include the type of treatment and give the estimated length (usually station to station), recommended width, and estimated depth (if applicable) of treatment. The recommendations should be sufficiently detailed in order to allow the designer to calculate contract quantities. Any special provisions, design details, material or design limitations/restrictions, design calculations with assumptions, settlement analyses, and slope stability analyses shall also be included in the Geotechnical Report, as applicable.

6.4.4.1 Removal and Replacement

Removal and replacement is a treatment option which may be considered for both settlement and stability concerns where the compressible and/or weak deposit is located at or near the existing ground surface. The economics of this method have to be questioned, when the depth of removal exceeds 12 ft.

For settlement mitigation, the compressible deposit may be removed and replaced by a suitable material, if economically feasible, unless considerations of stability require a more extensive treatment. As a treatment for stability, weak soil may be removed from the embankment foundation, and replaced by material of higher shear strength.

Normally, suitable earth borrow is satisfactory for replacement. In the case of a wet excavation, granular material must be placed to a height of 2 ft. above the water level observed at the time of placement. The balance of the replacement may be accomplished with suitable earth borrow.

For some applications, a variation from total removal and replacement may be economical. These techniques are discussed in the next section and include partial removal, partial removal and displacement, and load balancing.

6.4.4.2 Peat Bog Removal and Replacement Treatments

When a high embankment crosses peat deposits (peat bogs) or swampy areas, stability and/or excessive settlement must be considered. A bridging layer will not be sufficient treatment. Extensive removal and replacement will be needed. Load balancing with light weight fill is another option.

Although it is preferable to avoid a peat bog or swampy area, there are many times when they cannot be avoided. Through swamp areas, embankments must be constructed on a stable foundation. This helps avoid serious problems which may occur within a short time after completion. The manner in which this is accomplished, and the problems to overcome, depends largely on the type and depth of materials that exist in the swamp. The presence of peat or muck may be determined by the surface appearance and vegetation cover. However, a detailed program of boring and sounding is required for accurate identification of a peat bog.

Natural peat bogs often consist of several layers of peat, or combinations of organic and mineral deposits overlying stable mineral soil. While these upper layers may vary markedly in composition and exhibit a range in physical properties, they are entirely unsuitable as subgrades for major highways. Therefore, it becomes necessary to treat these materials in such a manner that they do not cause detrimental settlement; or perhaps, failure of the embankments and highways built upon them.

If it is economically feasible, removal is performed to a width half way out the embankment side slopes, as shown in [Figure 6.4.4.2-1](#). With dual pavements, it may be possible to partially remove peat bogs under median areas.

Depending on the depth and thickness of peat bogs, four removal options are described below:

- a) **Total excavation method** - This method can be used without major problems for swamps less than 12 ft. in depth. For greater depths, this method should only be recommended after considering:

- 1) stability of the excavation walls and the bottom;
- 2) difficulty with inspection;
- 3) the need for a temporary rolling surcharge and full-width trenching/backfilling in wet excavation;
- 4) the need for dewatering;
- 5) the rate of advancement of the embankment (and surcharge) in deep swamps, compared to the rate of excavation; and
- 6) in underwater excavation, the need for special means (such as a boat or raft) to probe or inspect.

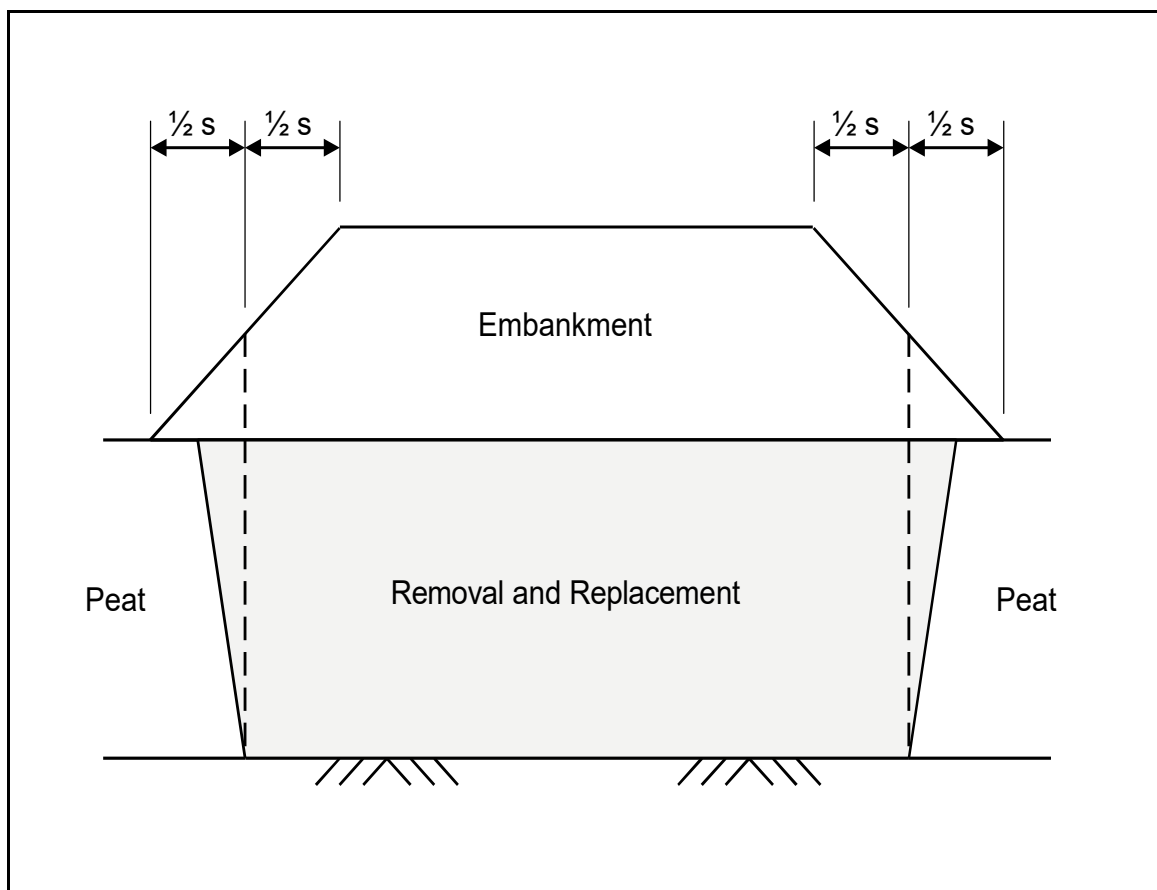

Figure 6.4.4.2-1 Width of removal and replacement in peat bogs

In a water filled trench, backfilling with granular material should be recommended to an elevation of 24 in. above the water level, to provide a stable platform. If soft marl is anticipated at the bottom of a dry excavation, a 2 to 3 ft. uncompacted lift of clean granular material at the bottom should be recommended.

- b) **Partial excavation** - For a small embankment on a peat bog, where settlement is the only concern, partial removal and replacement may be feasible. The geotechnical engineer must compute the amount of peat that needs to be removed, to reduce the settlement to a tolerable level. This must be based on laboratory consolidation tests. In general, the analysis will show that removing one half the peat does not remove half the settlement. Since the replacement material often weighs two or more times the weight of the peat removed, the remaining underlying peat settles more.
- c) **Partial excavation and displacement** - If the organic matter is too deep to be totally excavated, it may be advantageous to recommend a combination of partial excavation and displacement. The theory of this procedure is to overload the weak material, to such an extent that it is displaced by a rolling surcharge and by backfill material. A forward relief trench, combined with a surcharge, creates the condition of unbalance which causes displacement. Thus, the effectiveness of the treatment is directly related to the depth of the trench and the height of the surcharge. Failure to maintain adequate dimensions for the surcharge and trench is usually the cause of incomplete removal. Careful attention should be given to the plans that indicate the depth of removal, in order to assure complete removal of the peat. An open trench, at least 10 ft. deep and having a width approximately equal to the depth of the swamp or peat material to be removed, should be recommended in front of the rolling surcharge.

Cross sections for peat excavation quantities are needed, when this method of removal is employed. Therefore, it may be necessary, to conduct check borings after completion of the backfill for: 1) determining cross-sections for peat excavation and pay quantities; and 2) confirming that no unsuitable material remains underneath the embankment. Normally, check borings should be made at 50 ft. intervals, with 4 borings transverse to the centerline for single lane roadways, and 7 borings for dual roadways.

- d) **Load balancing with light weight fill** - When it is not feasible or economical to remove the peat bogs, it may be possible to “float” the new pavement. It is often possible, to remove enough existing soil such that it can be replaced by an equal weight of light weight fill ([Section 6.4.4.7](#)) plus the new pavement. Therefore, there is no increase in load to the peat. When calculating the depth of excavation, the buoyant weight of the light weight fill and pavement should be considered, to prevent the pavement from floating during periods of high groundwater and flooded ditches.

As with partial removal, partial load balancing may reduce settlement to a tolerable level, if the new load cannot be completely balanced.

Light weight fills do not stabilize or remove the peat; they merely “float” over the problem soils.

6.4.4.3 Drainage and Filter Systems to Aid in Consolidation

Drainage and filter systems can be used to shorten the drainage path and accelerate the dissipation of excess pore water pressure which develops in foundation soils beneath embankments during construction.

6.4.4.3.1 Drainage Blankets

When settlement problems arise, the time of settlement can be substantially reduced through the construction of a sand blanket. This blanket should consist of clean, drainable sand or granular material, not less than 24 in. thick. The blanket is placed over the original ground surface and serves as a drainage platform for the embankment. The granular blanket must be day-lighted at the sides of the embankment, or effectively tapped, in order to provide free drainage.

6.4.4.3.2 Vertical Sand and Wick Drains

As discussed in [Section 6.9.1](#), embankment construction above thick, high moisture content, fine grained soils may encounter problems with excessive settlement. If not addressed, the settlement could continue many years after job completion. One common technique to reduce the settlement time is through shortening the drainage path for surplus moisture in consolidating deposits. Use of sand or wick drains can accelerate drainage to reduce the settlement time and speed consolidation and strength gain of embankment foundation soils.

In the past, the most popular method for shortening the settlement time has been the use of vertical sand drains. However, the development of vertical wick drains has substantially reduced the use of the sand drains. Wick drains are also referred to as prefabricated vertical drains (PVDs), and they basically consist of a central grid or deformed plastic extrusion wrapped in a geotextile. These thin prefabricated wick drains can be literally stitched into the ground. Most commercially available products require minimum construction time and limited construction equipment and personnel.

Note that aggregate columns ([Section 6.4.4.8](#)) also have a structure similar to vertical sand drains, and they also shorten the drainage path and reduce settlement time in the same manner as vertical sand and wick drains. However, aggregate columns are primarily employed for other treatment purposes, such as reducing the settlement magnitude and increasing slope stability FOS.

Wick drains and sand drains have been successfully used by IDOT. A successful sand or wick drain operation requires a detailed subsurface analysis, design, and careful installation of the sand or wick drains. The detailed procedures should also consider the nature of the substrata and its influence on the success of the treatment.

In order to maintain free drainage, wick drains should be installed with either a drainage (sand) blanket or horizontal prefabricated drains at the base of the embankment. Piping or underdrains may also be needed to carry water away from a location. The geotechnical recommendations shall include the approximate limits of the area to install the wick drains, drain spacing and pattern (square or triangular), installation depth, and estimated time to achieve t_{50} and t_{90} (or other as required) within a project's construction time requirements. A range of spacing could also be provided to allow the designer the option to balance cost with the anticipated construction schedule. Submittals should include design calculations with assumptions listed in the Geotechnical Report.

Several geotechnical textbooks and technical references contain information for performing analysis, evaluation and design with vertical sand and wick drain treatments. Some references include:

- Elias, V., J. Welsh, J. Warren, and R. Lukas (1998), [Ground Improvement Technical Summaries: Volume 1, FHWA-SA-98-086](#)
- Rixner, J., S. Kraemer, and A. Smith (1986), [Prefabricated Vertical Drains: Volume 1, Engineering Guidelines, FHWA/RD-86/168](#)
- Naval Facilities Engineering Command (1986), [Soil Mechanics, Design Manual 7.01](#), Alexandria, Virginia, pp. 7.1-246 to 7.1-253

6.4.4.4 Preloading/Surcharge

The rate of settlement depends upon the thickness and permeability of the consolidating layer, the character of the drainage pattern, and the pore water pressure. Thus, a surcharge can be

used to speed up consolidation. However, care must be taken to assure the shear strength of the supporting soil is not exceeded; or a lateral squeeze may result. A simplified procedure ([Eq. 6.10.5.-1](#)) for computing the stability of the base is given in [Section 6.10.5](#).

The geotechnical recommendations for surcharge loading shall include the amount, location, and estimated duration of the surcharge loading.

6.4.4.5 Embankment Geometry

Embankment geometry is a function of the proposed roadway cross section and horizontal and vertical profile as need to accommodate traffic within a given terrain. Criteria for roadway embankment geometry are provided in the [BDE Manual](#). Several factors which may influence embankment geometry include roadside safety, economics, roadway drainage, erosion control, transitions in the terrain, adjacent structures, R.O.W. constraints, and environmental constraints. One example of this factor's influence can be found in Chapter 34 of the [BDE Manual](#) where benching embankments over 30 ft. tall may be considered in order to control erosion.

Geotechnical considerations can also be a factor in embankment geometry. Slopes can be rendered safer by flattening, which is effectively accomplished by placing berms on the embankment. The geotechnical engineer should coordinate with project's designer(s) to determine a range of available options and/or any constrains before evaluating alternative embankment geometries. In no case, should the berms be narrower than 10 ft., (ideally 15 ft.), in order to provide for adequate maintenance by mechanical equipment.

6.4.4.6 Instrumentation and Control of Embankment Construction

Many weak subsoils will tend to gain strength during the loading process, as consolidation occurs, and excess pore water pressure dissipates. A controlled rate of loading, or stage construction, may be utilized to take advantage of this strength gain. Proper instrumentation is desirable to monitor the state of stress in the soil during the loading period, to ensure that loading does not proceed so rapidly as to cause a shear failure. Instruments such as inclinometers, extensometers, and even less sophisticated devices are particularly valuable in monitoring early movement of the slope, toe, and crown areas.

6.4.4.7 Lightweight Fills

Lightweight fills are materials with unit weights lower than typical soil/aggregate unit weights. For embankments, they may be used as settlement and stability treatment options. Load balancing applications as discussed in [Section 6.4.4.2](#) combine a lightweight fill with partial removal of weak material. They may also be utilized without removal of existing material to reduce settlements and increase stability for embankment over soft, weak soils.

Lightweight fills that are available are:

- 1) cellular concrete at 20 to 50 pcf;
- 2) expanded clay aggregate at 40 to 70 pcf;
- 3) expanded polystyrene (EPS) blocks at 1 to 4 pcf;
- 4) light weight slag at 70 to 95 pcf;
- 5) sawdust; and
- 6) other materials.

There are special techniques needed for some of these products, and environmental concerns with others. Before these products are recommended or used, the engineer should be totally familiar with the cost, special construction techniques, durability, and effects on future construction and maintenance to the roadway.

The choice of lightweight material can be influenced by the onsite soil properties, water table depth, proposed cross section, pavement structure above the lightweight fill, and anticipated method of material placement. The experience level of local contractors and material availability can also impact cost. Some basic guidance on use of lightweight fill materials can be found in FHWA publication number [FHWA-SA-98-086](#) by [Elias et al. \(1988\)](#).

Detailed design calculations and recommendations shall be included in the Geotechnical Report. Buoyancy effects should be considered when calculating the depth of excavation and lightweight fill height, and the buoyant weight of the light weight fill and pavement should be accounted for in order to prevent the pavement from floating during periods of high groundwater and flooded ditches. The geotechnical design recommendations shall include the type of lightweight fill, material properties, and approximate vertical and horizontal limits of treatment in order to determine quantities for the lightweight fill. Any special provisions, material or design

limitations/restrictions, settlement analyses, and slope stability analyses shall also be included in the Geotechnical Report, as applicable.

6.4.4.8 Ground Improvement

Ground improvement techniques are used for deeper soil treatments to improve the properties of *in situ* soils. Such techniques may be a cost effective option depending upon the type and depth of the soil deposit. Common ground improvement methods include aggregate columns, deep mixing methods, deep dynamic compaction, vibrocompaction, and others. The feasibility of a particular method depends upon site conditions.

Aggregate Columns: Aggregate column ground improvement is suited for weak soils that are moderately deep where it is not practical to simply remove and replace. Aggregate columns are also referred to as stone columns, and they are basically the partial replacement of soft, weak *in situ* soil with compacted vertical columns of aggregate. Aggregate columns have been tried by IDOT, to increase the sliding resistance at the interface between an embankment and a weathered shale layer. They also have been utilized to reduce settlement and increase soil strength. Just like sand or wick drains, they can accelerate drainage, and speed consolidation and strength gain. Vibratory and tamper compaction methods of constructing aggregate columns are discussed in [GBSP 71](#).

Dynamic Compaction and Vibrocompaction: Dynamic compaction and vibrocompaction can be used to densify soils. However, consideration should be given to the vibrations generated from these methods and their potential adverse effects on adjacent structures and properties. Dynamic and vibrocompaction are best suited for granular soils.

Deep Mixing Methods: Deep soil mixing involves mixing a chemical binder material such as cement, lime, slag, or other cementitious material into *in situ* soils by a deep soil mixing rig. This method is typically able to reach depths near 200 ft. below the ground surface, and it is generally not cost effective for treating relatively shallow soils. The type and/or extent of modifying agent to employ should be determined by a laboratory mix design process. This process should optimize the amount of binder material needed for a project while simultaneously fulfilling required strength characteristics. It should also be noted that the proximity of a binder material source to a job site may be a factor in the cost of a particular material thereby affecting overall project cost.

Several technical references are available for basic guidance on ground improvement including:

- Elias, V., J. Welsh, J. Warren, and R. Lukas (1998), [Ground Improvement Technical Summaries: Volume 1, FHWA-SA-98-086](#)
- Barksdale, R., and R. Bachus (1983), [Design and Construction of Stone Columns, Volume I, FHWA-RD-83-026](#)
- Bruce, M., R. Berg, J. Collin, G. Filz, M. Terashi, and D. Yang (2013), [Federal Highway Administration Design Manual: Deep Mixing for Embankment and Foundation Support, FHWA-HRT-13-046](#)
- [Geotech Tools website](#) developed through SHRP2 of the Transportation Research Board: <https://geotechtools.geoinstitute.org/>

Ground improvement methods are generally more invasive and expensive than other treatment options. Construction specifications often also use an “end-result” approach that requires a contractor to provide a design which meets contractual requirements. Geotechnical engineers typically only need to evaluate these ground improvement techniques for the purposes of determining feasibility, effectiveness, and establishing cost estimates. Project specific specifications also typically need to be evaluated or developed.

The geotechnical design recommendations shall include the type of ground improvement, and approximate vertical and horizontal limits of treatment. Any special provisions, design details, material or design limitations/restrictions, design calculations with assumptions, settlement analyses, and slope stability analyses shall also be included in the Geotechnical Report, as applicable. Proposed use of ground improvement techniques for deep *in situ* soil treatments are required to be reviewed by the CBM and/or BBS on a project-by-project basis.

6.4.4.9 Embankment Reinforcement

Typical embankments are constructed of a considerable range of soil materials and will exhibit a wide range of shear strength. For embankments in excess of about 50 ft. in height with side slopes of 2 to 1, the need for some form of berming or internal reinforcement, to satisfy stability requirements, should be considered. IDOT does not allow embankments having side slopes steeper than 2 to 1, without berming or reinforcement.

Reinforcement (geotextiles or geogrids) add a tensile strength characteristic to the fill in an embankment. When properly placed, this system can raise the FOS to an acceptable range, or

even permit the steepening of side slopes under certain conditions. A stability study will be required to determine the position, vertical spacing, and number of such reinforcing elements within the embankment. This concept is generally limited to new construction and widening, provided that the width is sufficient, because the soil and reinforcing system are placed during construction. Applications of reinforcement in embankments are discussed in the following subsections.

6.4.4.9.1 Base Reinforcement

Geosynthetic products may be used to stabilize embankment bases over soft and very soft materials. This technique basically consists of placing horizontal layers of geosynthetic material near the base of an embankment. When the primary concern is stability rather than settlement, geotextiles and geogrids can be used separately or together to reinforce the base of the embankment against lateral spread and failure. The design presented in the Geotechnical Report must be analyzed for slope stability, bearing capacity, and settlement.

When reinforcement is employed, the length extending on either side of the failure plane(s) must be adequate. Sufficient friction or bond is required to prevent rupture of the reinforcement under the tensile force.

Several technical references are available for design guidance including:

- Holtz, R. D., B. R. Christopher, and R. R. Berg (1998), [Geosynthetic Design and Construction Guidelines, FHWA-HI-95-038](#).

For more information on the design and analysis of base reinforced embankments, the reader is referred to [Christopher et al. \(1989\)](#) and [Holtz et al. \(2008\)](#). For information on the corrosion and degradation of soil reinforcement, refer to [Elias \(1996\)](#) and [Elias et al. \(2009\)](#).

Design recommendations should be provided, including:

- Specifications for the geosynthetic material.
- The geosynthetic embedment length.
- Specific geosynthetic vertical locations and soil layer thicknesses.
- Embankment properties and compaction required.

A Special Provision should indicate the materials and construction techniques. Material properties that cannot be tested by the CBM must be certified by the producer. (Refer to [Section 6.16.2](#) for additional guidance in developing Project Specific Special Provisions.) The base reinforced embankment design should be submitted to the CBM and/or BBS for review.

6.4.4.9.2 Reinforced Soil Slopes

Due to the high cost of additional R.O.W. and retaining wall systems, a Reinforced Soil Slope (RSS) may be considered when there is insufficient R.O.W., environmental constraints, or other general constraints for utilization of a normal embankment side slope. An RSS system is generally compatible for slopes having inclines in the range of 30° to 70°, whereas a retaining wall should be utilized for slopes with inclines greater than 70°. An RSS must have both internal and external stability and tolerable settlement. Erosion should also be addressed.

6.4.4.9.2.1 RSS Analysis and Design

IDOT contracts can use either proprietary RSS systems or a specific design by the geotechnical engineer. For either method, the engineer shall analyze external stability and settlement. Also, the engineer shall provide any design recommendations necessary to ensure that the RSS system is stable, and that settlement is tolerable. If a proprietary system is used, internal stability shall be addressed in a contractor's (RSS supplier) construction/shop submittals. Otherwise, it should be analyzed by the geotechnical engineer for a specific design.

When reinforcement is employed, the length extending on either side of the failure plane(s) must be adequate. Sufficient friction or bond is required to prevent pull out of the reinforcement under the tensile force. When designing for permanent installations, it will be necessary to know the long-term creep properties of the geosynthetic proposed for use. The geosynthetic selected for soil strengthening should, ideally, mobilize its full working stress at relatively low rates of strain, and exhibit a high elastic modulus. This will better ensure that strain rates within the embankment

will be minimized. In all cases, a minimum FOS of 1.5 should be used for the external stability of the reinforced slope. Minimum FOSs for internal stability such as long-term allowable strength and pullout resistance will vary depending on the type of fill as discussed in publication number [FHWA-NHI-10-025](#) by [Berg et al. \(2009b\)](#).

Even with reinforcement, there is a limit to slope steepening that can be accomplished without considering: 1) special facing, to resist erosion; and 2) berming, to increase the safety factor. Hard armored facing is required for slopes steeper than 45°, and vegetated facing is permitted for lesser slopes. If site conditions warrant the use of an alternative facing treatment for slopes less than 45°, this shall be indicated on the plans. Hard armored facing may consist of gabions, wire mesh baskets, geocell, riprap, precast elements or other articulated units. The infill for hard armored facing may be vegetation, soil, or coarse aggregate.

Several technical references are available for design guidance including:

- Berg, R.R, B.R. Christopher and N.C. Samtani, (2009) "[Design and Construction of Mechanically Stabilized Earth Walls and Reinforced Soil Slopes, Volume I](#)," [FHWA-NHI-10-024](#)
- Berg, R.R, B.R. Christopher and N.C. Samtani, (2009) "[Design and Construction of Mechanically Stabilized Earth Walls and Reinforced Soil Slopes, Volume II](#)," [FHWA-NHI-10-025](#)
- Elias, V., K.L. Fishman, B.R. Christopher and R.R. Berg (2009), [Corrosion/Degradation of Soil Reinforcements for Mechanically Stabilized Earth Walls and Reinforced Soil Slopes](#), [FHWA-NHI-09-087](#)

For more information on the design and analysis of reinforced soil slopes, the reader is referred to [Elias et al. \(1996\)](#), [Elias et al. \(2001\)](#), Christopher et al. ([1989](#), [1990a](#), and [1990b](#)) and [Holtz et al. \(1998\)](#). For additional information on the corrosion and degradation of soil reinforcement, refer to [Elias \(1996\)](#) and [Elias et al. \(2009\)](#).

6.4.4.9.2.2 RSS Design Recommendations

The analysis and design recommendations needed in the Geotechnical Report will depend on if a proprietary system or a detailed project specific design is proposed. In either case, a Special Provision is required and should follow criteria similar to that discussed in [Section 6.16.2](#).

Proprietary RSS Systems: If a proprietary system is to be used, the plans should give line and grade drawings. To assist designers in estimating earthwork quantities adjacent to the RSS, design recommendations for proprietary systems shall also include preliminary estimate of geosynthetic embedment lengths.

A Special Provision giving reinforced slope design requirements, and a list of approved proprietary reinforced slope systems is required. The Special Provision shall indicate that the contractor (RSS supplier) shall be responsible for all internal and external stability aspects of the slope at all stages of construction. It shall also require the contractor (RSS supplier) design to provide the minimum factors of safety using the soil reinforcement Long-Term Allowable Strength (T_{al}) and Pullout Resistance, for the RSS fill proposed. A Special Provision for proprietary RSS Systems is available on the IDOT website: <http://www.idot.illinois.gov/doing-business/procurements/engineering-architectural-professional-services/Consultants-Resources/geotechnical-memorandums-and-provisions>.

Prior to construction, the manufacturer of the proprietary system or the contractor shall submit detailed shop drawings and stability analysis for review by the BBS and/or the CBM.

Detailed Project Specific RSS Designs: If the geotechnical engineer elects to perform a detailed RSS design, complete design recommendations should be provided, including:

- Slope angle.
- Specifications for the geosynthetic material.
- The geosynthetic embedment length.
- Specific geosynthetic vertical locations and soil layer thicknesses.
- Embankment properties and compaction required.
- Slope surface treatment.

A Special Provision for a detailed RSS design should indicate the materials and construction techniques. Material properties that cannot be tested by the CBM must be certified by the producer. The geotechnical engineer should analyze internal and external stability and settlement. The RSS design should be submitted to the BBS and/or the CBM for review.

6.4.4.10 Structure Option

Under special conditions, an area of weak soil may be bridged by a structure, and the concern for a stable embankment circumvented. Structures such as dry land bridges have been used to span peat bogs where the cost of remediation was substantial and prolonged secondary settlement was anticipated. Pile supported embankments and retaining walls are other examples of structure options to consider depending on a particular application. When considering a structure as a treatment option, maintenance requirements and life cycle costs should also be taken into consideration in the selection process. Refer to [Section 6.3.3.3.5](#) for additional criteria using a structure as a treatment option.

6.5 Cut Slopes

Much of the discussion provided in [Section 6.4.3](#) regarding slope stability analysis for embankments is also applicable to cut slopes. However, unlike embankment slopes which are constructed with a controlled fill material, the stability of cut slopes depends on the strength of existing soil encountered. The elevation of the groundwater table and seepage at the front face of a slope is also of importance for cut slopes.

6.5.1 Cut Slopes Stability

As discussed in [Section 3.4.2](#), slope stability analyses are required for cut slopes greater than 15 feet in depth. IDOT's current practice utilizes a **minimum FOS of 1.5** for cut slopes, based on **laboratory testing** of intact (relatively undisturbed) samples. If the stability analysis is based on the field (**Rimac**) tests of split-spoon samples, the **FOS should be 1.7** or greater. The higher FOS required for backslopes (cut slopes), as compared to embankments, is based upon the knowledge that cut slopes may deteriorate as a result of natural drainage conditions.

Refer to [Section 6.10](#) for performing slope stability analyses.

6.5.2 Remedial Treatments

Cut slope stability may be improved by the following:

- Flattening of Slopes

This can most effectively be accomplished by benching. Benches should be at least 10 ft. wide (ideally 15 ft.) in order to provide for proper construction and maintenance.

- Improvement of Drainage

Groundwater seepage at the face of a cut slope, or a perched water table (due to a soil contact with a less permeable underlying layer) may result in sloughing, or other problems. Drainage cutoff trenches may be designed to intercept the seepage, and thus, render the slope face stable.

Under special conditions, stability may be provided by some erosion protection measures or by a properly designed retaining structure which includes retaining walls, rock buttresses, binwalls, or sheeting walls.

Specific design recommendations must be provided to ensure cut slope stability, if the analysis shows an unacceptable FOS.

6.5.2.1 (Reserved)

6.5.2.2 Drainage and Filter Systems in Backslope Applications

When the depth of a cut section for a roadway becomes sufficient to intercept the groundwater surface, seepage tends to break out on the face of the backslope (cutslope). Left unattended, such seepage can result in localized sloughing of the slope, and eventual instability of the slope face.

When the elevation of the groundwater table is reasonably well established at the time of the soil survey, the elevation and extent of backslope drains can be detailed in the design plans. There are two popular remedial techniques for draining backslopes: 1) A pipe collector in a longitudinal trench, backfilled with a suitable granular filter; and 2) the construction of a reverse filter on the face of the slope. In the reverse filter drain, the finer granular material first blankets the soil slope, and is then covered by coarser material, with the coarsest at the surface. The reverse filter drain may not be entirely satisfactory unless the slopes are, at least, as flat as 3H to 1V. With both of these drains, the basic rules for success are similar to [Section 6.3.4.2](#).

French drains are also used to drain backslopes. A French drain consists of a trench, lined with a suitable filter fabric, and backfilled with an open graded, coarse stone (without a collector pipe). Care must be taken when considering French drains for backslopes. The permeability of the stone, the cross section of the trench, and the trench gradient must be adequate to effectively conduct the inflow. Failure to provide for adequate drainage of the seepage water will eventually make the slope face saturated again.

The more desirable alternative, when the groundwater elevation is known, consists of excavating the backslope down to this elevation. Further excavation of the cut is performed after the construction of the backslope drain. With the drain installed, the remainder of the cut may then be excavated without incident.

6.5.2.3 (Reserved)

6.5.3 (Reserved)

6.6 Erosion Control

At IDOT, erosion control is not the responsibility of the DGE or any one individual. Each District has engineering staff trained to administer the design and inspection of erosion and sediment control work. Department personnel and engineering consultants involved with design and construction inspection of erosion and sediment control must complete the required training as outlined in the [Design and Environment Department Policy D&E-23](#).

[Design and Environment Department Policy D&E-23](#) establishes an erosion and sediment control training program for engineering consultants and Department staff. This training program provides a general understanding of the Clean Water Act, 33 U.S.C. 1251 et seq. and specific responsibilities for design and construction of erosion and sediment control under the NPDES permits program, Title 40 CFR Part 122. Erosion & Sediment Control Workshop courses are available through the [Illinois Center for Transportation](#).

Erosion can dramatically affect soil stability, construction, and long term performance of projects. Construction activities that are subject to high erosion risks, include R.O.W. clearing, earthwork, ditch construction, use of haul roads, culvert installation, channel changes, pier or abutment work in streams, use of temporary stream crossings, borrow pit operations, and hydraulic or mechanical dredging. Factors that affect erosion include rainfall intensity, the natural slope, soil type, rate of runoff, and depth and velocity of runoff. Much attention by both Federal and State governments has been directed to the control of erosion and sedimentation. As a result, highway construction specifications consider protective measures, to reduce detrimental effects on land and water. Erosion and sediment control items of work are included in plans for projects subject to the Department's National Pollutant Discharge Elimination System (NPDES) permits.

Erosion potentials should be assessed during the design phase (Phase II). Soil types, anticipated cuts and embankments, grades, proximity to critical areas, and channel change requirements should be studied and cost estimated, if special protection is necessary. Therefore, design recommendations should consider IDOT's policies and follow widely recognized and generally accepted Best Management Practices in the design and construction of erosion and sediment control. [Section 8.13](#) provides some general guidance on the proper construction procedures to reduce erosion.

To address long term performance, Roadway Geotechnical Reports shall provide a summary of the locations, estimated depths, and estimated extent of high erosion potential soil types identified in the geotechnical study which may be exposed in cuts or placed in fills along with recommend treatment options. Soils types with high erosion potential generally include silts, sands and some gravel when exposed at the ground surface on slopes. Where slopes and hydraulic conditions do not require hard armament, treatment of exposed high erosion type soils may consist of capping with layer of cohesive soil and subsequent vegetation. However, recommendations for positive drainage, such as riprap or subsurface drains ([Section 6.3.4.3](#)) should be provided if there is a concern about entrapping groundwater which may lead to potential surficial sloughing or deeper slope failures.

Chapter 41 of the [BDE Manual](#) may be referenced for additional information on policies regarding erosion control and slope treatments. [BDE Manual](#) Figure 41-2.A provides a summary of slope treatments and maximum slope gradients. Additional information on the various forms of slope protection is also provided in the following sections of the [Standard Specifications](#):

- Section 250: Seeding
- Section 251: Mulch
- Section 253: Virginia Creeper (when vining plants are desired)
- Section 280: Temporary Erosion Control
- Section 281: Rip Rap
- Section 284: Gabions and Slope Mattress
- Section 285: Concrete Revetment Mat

6.7 Storm Sewers

Design recommendations may need to be provided for storm sewer design and construction. Since only a preliminary geotechnical exploration is, usually, performed in the planning phase (Phase I), very little may be known about the drainage system. The geotechnical engineer will have to make assumptions about the storm sewer depth, diameter, and type. An addendum to the Geotechnical Report may be necessary, once the details of the drainage system are finalized in the Design Phase (Phase II). Unless special conditions warrant otherwise, design recommendations should be consistent with the [Standard Specifications](#).

The storm sewers need a stable base for construction and should not be subjected to excessive settlement. If the proposed storm sewer crosses weak soil, but the grade is not being raised, a working platform no thicker than 12 in. should be sufficient to provide a stable base during construction. If the grade is being raised (which will cause the storm sewer to settle), the geotechnical engineer and designer must determine how much settlement is tolerable. Soil treatment should be considered in the same manner as for subgrades. It may also be feasible to use pipe with special joints that tolerate large amounts of differential settlement.

The contractor is responsible for trench sidewall support. However, in cases where stability of surrounding structures or facilities would be affected, the Geotechnical Report should provide recommendations to assure safety and stability. It is likely that quantities for sheeting, or provisions alerting a contractor to special requirements, will be provided in the plans or Special Provisions.

The contractor is responsible for keeping the storm sewer excavation dry. However, when a normal sump and pump system will not be sufficient, design recommendations must be provided. The contract plans must alert the bidders to the probable need for special dewatering, or the plans should provide quantities for sheeting, well points, or some other appropriate groundwater control method.

When the proposed storm sewer system will be below the permanent or seasonally fluctuating groundwater elevation, and the soil consists of fine sand or silt; rubber gaskets should be recommended for the pipe joints. Mastic joints may leak if not properly applied, and the fine sand or silt may infiltrate into the pipes causing loss of ground support. Rubber gaskets are a more reliable seal.

6.8 Structures

The Geotechnical Report for a structure must present design recommendations for structure type, foundation type, allowable loads, and constructability. The analyses performed to develop the recommendations must also be given in the Report. If more than one structure type, foundation type, or construction method are feasible, the designer must be given the information necessary to evaluate alternatives.

6.8.1 Design Criteria Overview

Geotechnical analysis and design of transportation related structure foundations should generally be in accordance with the [Bridge Manual](#), [Culvert Manual](#), and the “AASHTO LRFD Bridge Design Specifications” ([AASHTO, 2020](#)), current at the time of publication of this Manual, using the load and resistance factor design approach. Occasional exceptions are noted where geotechnical design should still be performed using the allowable stress design (ASD) approach and/or in accordance with the 2002 AASHTO Standard Specifications for Highway Bridges, 17th Edition ([AASHTO Standard Specifications](#)). Numerous references are also contained in subsequent subsections to other FHWA design manuals to either address areas not specifically covered by AASHTO, or to supplement the guidance given by AASHTO. In addition, Departmental policies and design requirements are indicated herein, or reference made to Design Guides or other Department manuals, when local experience or research has been used to establish policies and design requirements that deviate from AASHTO and FHWA manuals.

6.8.2 Structure Type and Scope

The geotechnical analyses for highway structures are dependent on site conditions, and the type of structure being addressed. The following are the type of structures generally utilized on the highway system, and the minimum scope of geotechnical analyses and design recommendations.

6.8.2.1 Bridges

In Illinois, highway bridges can vary from small and simple grade separation or stream crossing structures, to very large and complex structures like the bridges over the Mississippi River. Regardless of its size, the geotechnical aspects of a bridge structure depend, to a large extent, on its topographic and geologic settings. Several classification systems exist for differentiating various types of single- and multiple-span bridges. The **superstructure** of a bridge refers to the

bridge **deck** (or roadway surface) which is supported by two or more beams or girders. The **substructure** of a bridge refers to the support structures, on which the superstructure rests. At the ends of the bridge are the **abutments**, and at intermediate locations are **piers** and/or **bents**. In **simple multiple-span bridges**, the superstructure is not structurally **continuous** over the intermediate substructure units. The superstructure is broken by various transverse joints. In continuous bridges, the superstructure is structurally continuous over one or more piers (or bents).

In Illinois, a frequently-used type of structure is the **integral abutment bridge**, wherein the superstructure (deck and beams) is cast integrally with the supporting abutments. In these structures (both single- or multiple-span structures), there are no joints in the bridge's superstructure.

Spill-thru pile bent abutments refer to those types of abutments where a concrete cap sits on top of one or more rows of piles (or drilled shafts). The embankment or fill material (**bridge cone**), supporting the roadway approach to the bridge, spills through or in between the supporting piles or shafts. With a **closed abutment**, the bearing seats, supporting the superstructure, rest on a vertical retaining wall which is supported by a footing. The footing may be a spread footing or a pile cap, supported by piles or drilled shafts. Variations of these two abutment types exist.

6.8.2.1.1 Analyses for Bridges

The basic geotechnical analyses that should be addressed for the bridge substructures are the following:

- a) Slope Stability – This refers to the stability of the slope at the end of the bridge, commonly referred to as the endslope. The endslope can be a river bank, a constructed bridge cone, a cut, or a closed abutment. The correct geometry should be modeled in these analyses. Circular arc analysis using the Simplified Bishop analysis and the sliding wedge analysis, when applicable, should be performed. For fill slopes the minimum FOS should be 1.5 when based on SPT field data, and 1.3 when using Shelby tube lab data. For cut slopes, the minimum FOS should be 1.7 when based on SPT field data, and 1.5 when using Shelby tube lab data.
- b) Settlement – Settlement is a concern when a new embankment or fill is proposed to be placed on relatively weak and compressible soils. Settlement at a bridge approach can affect the behavior of the abutment, where down drag or negative skin friction can impose

additional loads on the abutment piling or drilled shafts. Significant bridge approach settlement creates an undesirable bump on the roadway. Unless a pier is located in an embankment, IDOT experience has shown pier settlement to be insignificant. The reason is bridge pier spread footings must rest on a foundation soil with a Q_u of 2.0 tsf or greater. In weaker deposits, deep foundations for abutments or piers are utilized to preclude significant settlement.

- c) Foundations – The scope of bridge foundation analyses should address the foundation needs for the piers and abutments, based on available soils data, and should result in the most suitable and economical foundations. See [Section 6.13](#).
- d) Miscellaneous – Under this scope-of-work, the need for cofferdams, seal coats, braced excavations, stage construction shoring, and other special conditions should be addressed.

6.8.2.1.2 Design Recommendations for Bridges

Design recommendations for bridge piers and abutments should include foundation type (spread footings, piles, or drilled shafts), allowable pressures, and the predicted settlement. Any soil treatment required for spread footings should be given. Foundations for bridges over streams must be designed to be stable under conditions of maximum calculated scour. Refer to [Section 7.4.5](#) for additional guidance on reporting design recommendations for bridges.

6.8.2.2 Culverts

The DGE is typically not involved with selection or installation of pipe culverts, which are usually used for hydraulic openings of smaller discharges. However, this is not the case for box culverts, which are usually made up of more than one cell. At the ends of the culvert, **wingwalls** are usually constructed to retain the earth adjacent to the culvert, preventing it from sliding into the stream. **Horizontal cantilevered wings** are, as the name implies, structurally continuous with the outside walls of the culvert. These wings do not require any supporting foundation. On the other hand, T-Type vertical and L-type vertical cantilevered wings are, more or less, structurally independent of the culvert, and require separate foundation assessments.

6.8.2.2.1 Analyses for Culverts

Geotechnical analyses and evaluations for culverts should address the following:

- a) Slope Stability – In this analysis, the overall slope height of the roadway embankment used could be from roadway grade to flow line, or to the toe of the side slope, depending on the angle of culvert skewness with respect to the roadway.
- b) Settlement – Settlement can be a concern when a relatively significant embankment is proposed to be placed over the culvert, and the culvert is founded on weak and compressible soils. The settlements both below and adjacent to the culvert should be calculated, based on consolidation tests. Settlement problems may be resolved through the use of articulated joints in the culvert. For details, see the IDOT [Culvert Manual](#).
- c) Foundations – The foundation needs of the culvert wingwalls should be addressed. Sometimes foundation deficiencies can be addressed through modifications of the wingwalls or changing the type of wingwalls. If cofferdams are needed to construct wingwall footings, consider the use of cantilevered sheet pile wall, with or without concrete facia.
- d) Remedial Treatments – Discuss remedial treatments to address slope stability, settlement, and construction problems, if any.

6.8.2.2.2 Design Recommendations for Box Culverts

Design requirements for box culverts include any soil treatment required for support of the culvert and reduction of settlement, foundation recommendations for wing walls supported on soil, and drainage requirements.

6.8.2.2.3 – 6.8.2.2.7 (Reserved)

6.8.2.3 Three Sided Structures

A three sided structure is a buried structure which is similar to a box culvert except that it has an open bottom with the side walls supported by foundations, and it must be built through precast fabrication. There are a variety of potential reasons why structure planning engineers specify three sided structures. Some typical examples are when debris collection on piers or culvert cell walls can be a concern which is avoided by having a large single span opening, another advantage is its quick construction time, avoidance of cofferdams, and the environmental advantage of having a natural stream bottom.

The [Guide Bridge Special Provision](#) (GBSP 15) for three sided structures shall be included in the contract documents; and among other things, it requires a contractor to design the foundation for both the three sided sections and the wing walls. The Department maintains a pre-qualified list of proprietary structural systems allowed to provide three sided structures. This list can be found on the Departments web site under the “[Prequalified Structural Systems](#)” drop-down located under the “Bridges and Structures” Tab.

For these foundations, the geotechnical engineer responsible for the SGR should evaluate the feasibility of water diversion as well as reporting if shallow foundations ([Section 6.13.1](#)) would be feasible and if remedial treatment to the foundation soils may be needed. In cases where shallow foundations are not feasible, the use of piling and drilled shafts should be addressed. However, it should be noted in the SGR, that the actual design of a three sided structure is finalized during the construction phase of a project. Although the SGR is not written for contractor use, it should identify all of the design and construction challenges a contractor is likely to face, provided accurate soils data for the contractor’s design, assure that the three sided structure was the most cost effective and/or feasible structure type, and ensure that a contractor has no basis on which to file a claim against the department.

When scour is an issue, sheet pile supported foundations may occasionally be specified as cutoff walls to retain the backfill soils as well as provide vertical and lateral support in combination with riprap, fabric formed revetment mat, or other scour countermeasure system on the contract plans prior to final design of a three sided structure foundation. The SGR should address sheet piling if it is being considered in the structure planning process or if the geotechnical engineer elects to suggest it as an alternative. In other cases, with soft soils which required batter and vertical piles, the geotechnical engineer should report the design data for pile foundations ([Section 6.13.2.3.1.4](#)).

6.8.2.4 Retaining Walls

(This section is currently under development.)

Refer to [Section 6.19](#) contains links to Design Guides and corresponding spreadsheets for:

- “Temporary Geotextile Wall Design”
- “Temporary Sheet Piling Design Charts”
- “Permanent Sheet Pile Design Policy” (All Bridge Designers Memorandum 11.4)

6.8.2.4.1 – 6.8.2.4.5 (Reserved)

6.8.2.5 Miscellaneous Structures

There are some other highway features which require foundations for support. Examples include traffic signal mast arms, high mast light towers, various sign structures, and noise abatement walls. Refer to [Section 6.13.5](#) for discussion on foundation analyses and design recommendations of these structures.

6.8.3 Drainage and Drainage Systems for Structures

Water can have a major adverse effect on the loadings (both hydrostatic and earth pressure) a structure must resist. When possible, drainages systems should be utilized to prevent water pressure buildup by collecting any seepage water and delivering it to a ditch or slope via weep hole or pipe drain. The Department had developed standard drainage systems to be installed behind bridge abutments, retaining walls, and soldier pile walls. These typical drainage systems are presented in the following figures in the [Bridge Manual](#):

- Figure 3.8.3-2 shows a typical drainage system behind integral abutments
- Figures 3.11.2.3-1 and 3.11.2.3-2 show typical drainage system details for T-type walls and closed abutments
- Figures 3.11.3.2.1-1 thru 3.11.3.2.1-4 shows typical drainage system details for soldier pile walls

6.9 Settlement Analyses

There are three potential mechanisms which may contribute to the total settlement of soil due to placement of a new load: primary consolidation (S), secondary consolidation (S_{α}), and immediate settlement (ρ_i). The total settlement, S_T is the sum of these the mechanisms.

$$S_T = S + S_{\alpha} + \rho_i \quad (\text{Eq. 6.9-1})$$

Only those settlement mechanisms which are significant to the construction and performance of an embankment or foundation need to be determined for a settlement analysis. The discussions herein are limited to settlements caused by the compressibility of existing natural soils. Settlement within the new embankment will be minimal, if it is constructed according to the proper compaction requirements, as given in the [Standard Specifications](#).

[Section 6.9.1](#) discusses consolidation settlement. [Section 6.9.2](#) provides guidance on immediate settlement, and [Section 6.9.3](#) is a brief overview of other settlement types. [Section 6.9.4](#) addresses remedial treatments of settlement for structure foundations. The effects of the settlement on a structure may be tolerable or detrimental; depending on the magnitude of settlement, foundation type, and foundation geometry. For discussion on remedial treatments of embankment settlement, refer to [Section 6.4.2](#).

6.9.1 Consolidation Settlement Analysis

This section addresses only the consolidation settlement in the natural ground, under the embankments and shallow foundation loads. Normal construction practices are usually adequate to preclude excessive post construction consolidation within the embankment.

Consolidation settlement takes place when the weight of a new load, such as an embankment or shallow foundation, exceeds the previous stress history of the underlying strata. In this case, the soil particles are pressed more closely together. The amount of settlement is a direct measurement of the reduction in the soil voids space.

Soil settlement mechanisms which may affect the embankment construction and performance consists of primary and secondary consolidation. Primary consolidation is the portion of the consolidation curve in which the reduction in void ratio is associated with the dissipation of excess pore water pressure. The pore pressure depends on soil permeability, which is a function of the

particle size. Granular materials are sufficiently permeable to dissipate excess pore water pressure as quickly as the embankment load is applied. At the other extreme, thick deposits of wet, high clay content soil may not achieve equilibrium pore water pressure for decades.

Secondary consolidation occurs after full dissipation of excess pore water pressure. Secondary consolidation is a problem with high organic deposits, such as peat. For peats, the total secondary consolidation could be twice as much as the primary consolidation. With mineral soils, the secondary consolidation is not commonly considered a problem. The consolidation characteristics of fine grained soils are evaluated in the laboratory, on specimens taken from intact (relatively undisturbed) samples. The methods of calculating the primary and secondary settlements, as well as the consolidation times (t_{90} and t_{50}), are illustrated in [Appendix D](#).

6.9.1.1 Preliminary Assessment

The geotechnical engineer should have enough experience to recognize and determine, from the available SPT boring data and other site conditions, if significant settlement may occur. For soft, normally loaded clay deposits, the method given in this section ([Equations 6.9.1.1-1](#) and [6.9.1.1-2](#)) may be used to obtain a preliminary estimate of settlement, and to determine if further evaluation is warranted.

It has been IDOT's experience that saturated soil deposits, with moisture contents in the low 20's, seldom experience significant settlements. When moisture contents reach 25% or more, there is greater concern. This is especially true with a thick soil stratum.

If consolidation test data is not available, the primary settlement (S) can be estimated if the natural moisture content (W_n) is known. Assuming $W_n = LL$, the compression index (C_c) is calculated from the following empirical formula:

$$C_c = 0.009 (W_n - 10) \tag{Eq. 6.9.1.1-1}$$

The settlement (S) is then calculated as:

$$S = \frac{C_c H_L}{(1+e_o)} \text{Log} \left(\frac{P_o + \Delta P}{P_o} \right) \tag{Eq. 6.9.1.1-2}$$

Where:

S = estimated primary settlement

H_L = thickness of compressible soil layer

C_c = compression index (dimensionless)

e_o = initial void ratio

P'_o = effective overburden pressure at the center of the compressible soil layer

$\Delta P'$ = increase in stress at the center of the compressible soil layer resulting from embankment or foundation loads

Note: Boussinesq's solutions are utilized in determining the increased stress at the center of the compressible soil layer ($\Delta P'$); however, different methods/equations are utilized for embankments and foundations depending on the shape of the load. For long embankments, refer to [Appendix D.8](#) for determining the increased stress at the center of the compressible soil layer ($\Delta P'$). For shallow foundations and other load configurations, the applicable Boussinesq method can be found in most foundations textbooks.

The above procedure is used to determine consolidation prone soil deposits that may require intact (relatively undisturbed) sampling for further laboratory evaluation. This simplified procedure is based upon the assumption the soil is a saturated, normally consolidated, and an insensitive clay. Any deviation from these assumptions will substantially reduce the amount of settlement calculated by this procedure. In addition, while this method may yield a degree of insight into the amount of settlement, it furnishes no clue as to the settlement time.

For very soft to soft clays (Q_u between 0.25 and 0.50 tsf), the settlements computed by this method are likely to be reasonably accurate. For medium and stiff clays (Q_u between 0.5 and 2.0 tsf), the actual settlements are likely to range between one-fourth and one-tenth of the computed values.

A Design Guide titled "*Cohesive Soil Settlement Estimate*" and corresponding spreadsheet is available for performing a preliminary settlement estimate and is discussed in [Section 6.19](#). This spreadsheet may not be applicable to all situations, and engineering judgment should be utilized in its usage.

If the preliminary assessment determines that further investigation is warranted, refer to [Section 6.9.1.2](#).

6.9.1.2 Consolidation Tests and Settlement Analysis

If the preliminary estimate of settlement is significant enough to negatively impact the behavior of the structure, a more accurate settlement analysis is required. Data should be obtained from consolidation tests on representative Shelby tube samples. See [Section 5.5.13](#) for a detailed discussion of the consolidation test. The settlement analysis, based on the test, is explained in [Appendix D](#). The procedures in [Appendix D](#) include calculations for the amount of both primary and secondary consolidation as well as calculations for estimating time to achieve a certain percentage of primary consolidation.

When conducting shallow foundation and MSE wall settlement analyses, note that the equations in [Appendix D](#) correspond with those given in Article 10.6.2.4.3 of the “*AASHTO LRFD Bridge Design Specifications*” ([AASHTO, 2020](#)). However, calculations for the increased stress at the center of the compressible soil layer ($\Delta P'$) in [Appendix D.8](#) are for long embankments. For shallow foundations, MSE walls and other load configurations, the applicable Boussinesq solution found in most foundations textbooks should be utilized in determining $\Delta P'$.

6.9.2 Immediate Settlement Analyses

Elastic settlement, which is commonly known as immediate settlement, is the deformation of the soil that occurs as a load is placed on it without change of moisture. This type of settlement is not a concern for embankment construction since the top of the embankment can be built to plan grade without any concern for settlement of granular deposits impacting the embankment construction or function. However, immediate settlement in granular deposits should be calculated for serviceability of shallow foundations and MSE walls. Immediate settlement should also be calculated if piles are also driven in advance to construction of an MSE wall abutment founded on granular deposits. If the total settlement of the soil around the piling is more than 0.4”, then pile driven capacity must account for downdrag ([Section 6.13.2.3.2.2](#)).

The potential settlement of granular soils can be estimated using elastic theory or empirical techniques such as the Hough Method discussed in Article 10.6.2.4.2 of the “*AASHTO LRFD Bridge Design Specifications*” ([AASHTO, 2020](#)). For layered granular deposits with widely differing N-values, the Schmertman Method is adequate, and can be found in most foundations textbooks. When SPT data suggests that the soils are homogeneous and of similar density, other simpler empirical methods are available for estimating settlement. The empirical method chosen by the geotechnical engineer should be documented in the Geotechnical Report.

6.9.3 Other Settlement Types

Other types of settlement include mine subsidence are beyond the scope of this section. For roadways, mine subsidence has appeared in some locations as long, gradual dips in the roadway profile that resemble small hills. In these cases, the pavement deflection was gradual enough to not impact the function of the roadway. However, other instances may occur where the subsidence appears similar to a small sink hole. Isolated occurrence like these should be addressed on a case-by-case basis.

Mine subsidence can also be devastating to structures. This type of settlement is most difficult to assess. However, the geotechnical engineer should know if the project site has been mined, if subsidence problems have already occurred in the mined area, or if subsidence is anticipated. The use of all simple spans with cable ties over the piers might reduce subsidence damage.

6.9.4 Settlement Evaluation and Remedial Treatment for Structures

This section provides general guidance on evaluating settlement of structures. Refer to the applicable sub-section of [Section 6.8](#) or [Section 6.13](#) for additional settlement evaluation information regarding a specific structure type or foundation type, respectively. For evaluation and remedial treatments of embankment settlement, refer to [Section 6.4.2](#) and [Section 6.4.4](#), respectively.

The magnitude of settlement and time to achieve a certain percentage or degree of consolidation can significantly influence a project's design, duration, and cost. For some soils, primary and secondary consolidation can continue to occur long after an embankment is constructed. Post construction settlement can damage roadways, structures, and utilities located within an embankment. Embankment settlement near an abutment could create a substantial dip in the roadway surface, or downdrag and lateral forces on foundations. The impact of settlement can often be mitigated if the primary consolidation is allowed to occur prior to placing infrastructure elements that would otherwise be impacted by the settlement. However, it should be noted that it can range from a few weeks to possibly years for primary settlement to occur, and significant secondary compression of organic soils can continue for decades.

Remedial treatment of excessive settlements is warranted when the amount and time of settlement will adversely affect the behavior of the structure. For example, a large and rapidly occurring settlement under a new bridge cone will not have any effect on the structure, if most of

the settlement occurs prior to the abutment foundation construction. Conversely, a similar settlement case under a culvert would be damaging, because the culvert has to be in-place before the embankment is constructed. Therefore, the latter case would require corrective measures.

Realizing that some settlement takes place during construction, usually a maximum total settlement of 3 in., at a bridge cone or under a culvert is generally considered acceptable. However, negative skin friction on pile foundations, due to the settlement, should be considered in the design.

Coordination between the geotechnical engineer and designer is often necessary to evaluate the amount of construction time that may be available for a waiting period to allow for settlement to occur. Many construction projects cannot absorb the scheduling impacts associated with waiting for primary consolidation and/or secondary compression to occur. Therefore, estimating the estimated time to achieve a certain percentage or degree of consolidation is often as important as estimating its magnitude. When a waiting period is not feasible, the effects of settlement shall be explicitly designed for (such as downdrag loads), or treatment options explored that will either minimize the magnitude or shorten the waiting period to achieve a desired degree of settlement. The magnitude of settlement, estimated settlement time(s), required waiting periods, its potential effects, and recommended treatment options shall be reported by the geotechnical engineer, as applicable. Remedial treatments for structures are similar to those for embankments. Some of the corrective measures that IDOT has used to mitigate settlement problems are mentioned in [Section 6.4.2](#) with further discussion in [Section 6.4.4](#).

6.10 Slope Stability Analyses

The term “stability” is generally applied in two distinct ways by the Department when evaluating subgrades and embankments (or cut) slopes. When evaluating subgrades and compacted embankment fill, stability pertains to the behavior of a layer of soil or aggregate material. For embankment or cut slopes, the term refers to the stability of a slope against global and/or localized failures.

6.10.1 General Failure Mechanisms

The principal modes of failure (slip) in soil or rock are: 1) rotation on a curved slip surface, approximated by a circular arc; 2) translation along a planar surface, whose length is large compared to depth below ground elevation; 3) displacement of a wedge shaped mass, along one or more planes of weakness. Other modes include: toppling of rock slides, falls, block slides, lateral spreading, earth and mud flows in clayey and silty soils, and debris flows in coarse grained soils. The books by Turner and Schuster (1996) and Abramson et al. (1994) contain details and illustrations of the different modes of slope failure. As a word of caution, in stability studies, the geotechnical engineer should be aware of any ditches to be located at or near the toe of the slope.

A slip circle could be a base circle, a toe circle, or a slope circle. A base slip circle develops when there is a significant thickness of weak foundation soil. The base of the failure arc is tangent to the base of the weak layer, and the arc will have a significant portion of its length in the weak soil. A slope circle develops within the embankment and intersects with the slope. Sloughing of the slope, due to erosion, is an example of a slope slip circle. A toe slip circle develops in the embankment and intersects at the toe. This happens, sometimes, when the embankment material becomes saturated and failure occurs.

A planar failure is more commonly associated with the shear plane following a thin zone of weakness and is seldom far below the base of the embankment or toe of slope. The failure plane may develop at the soil-shale contact, with seepage on the shale surface. The planar failure may also develop at the base of an embankment. This could happen when an organic layer and vegetative cover have been inadequately processed during construction, resulting in a built-in failure plane.

Block movements are more common to cut sections through relatively competent soils; such as a weathered glacial till. The movements take place along secondary structural cracks and joints.

Residual soils may also fall into this group, with the plane of movement taking place along relic joints and bedding planes.

- a) Embankment Slopes – Slope failure takes place when the sliding forces exceed the resisting forces. The force imbalance may be caused by one or more of the following situations, for embankment slopes:
- 1) Slope profile changes that add driving weight at the top or decreases in the resisting force at the base. Examples would be the steepening of the slope or undercutting of the toe.
 - 2) Vibrations induced by earthquakes, blasting, or pile driving. Depending on their frequency and intensity, induced dynamic forces could cause either liquefaction or densification of loose sand, silt, and loess below the groundwater surface. Dynamic forces could cause the collapse of sensitive clays, thereby, resulting in increased pore pressures. Also, see [Section 6.12.3](#) for the effect of seismic liquefaction.
 - 3) Overstressing of the foundation soil. This may occur in cohesive soil during or immediately after construction. Usually, short-term stability of embankments on soft cohesive soil is more critical than long-term stability, because the foundation soil will gain shear strength as the pore pressures dissipate. It may be necessary to check the stability for various pore pressure conditions. Usually, the critical failure surface is tangent to a firm layer underlying the soft soil.
- b) Cut Slopes – The stability of cut slopes made in soft cohesive soils depends on the strength of the soil, the slope angle of the cut, the depth of the excavation, and the depth to a firm stratum (if one exists not too far below the bottom of the excavation). The stability of cut slopes in granular soil is highly influenced by the groundwater level and friction angle.

Cut slope failure in soil may result from the following:

- 1) Changes in slope profile which result in the increase of driving forces, and/or a decrease in the resisting forces. Additional embankment on top, steeper side slopes, or undercutting of the toe are examples.
- 2) An increase of pore water pressure, resulting in a decrease in frictional resistance in cohesionless soils, or swell in cohesive soils. An increase in pore pressure could result from slope saturation by precipitation, seepage, or a rise in the groundwater elevation.
- 3) Progressive decrease in shear strength due to weathering, erosion, leaching, opening of cracks and fissures, softening, and gradual shear strain (creep).

- 4) Vibrations induced by earthquake, blasting, or pile driving, as explained above in [Section 6.10.1](#) a) 2).
- 5) Earth slopes subjected to periodic submersion (for example, along streams subject to water fluctuations). Also, loss of integrity due to seepage water moving to the face of the cut (piping).

Failures in cut slopes involving rock or soil/rock may result from:

- 1) Chemical weathering.
- 2) Freezing and thawing of water in the joints.
- 3) Seismic shock.
- 4) Increase in water pressure within the discontinuities.
- 5) Alternate wetting and drying (especially in expansive shales).
- 6) Increase in tensile stress, due to differential erosion.

6.10.2 Preliminary Assessment

Experience can be very helpful in recognizing whether a stability problem exists at a bridge cone, an embankment over a culvert, or a retaining wall. The rule of thumb [Eq. 6.10.5-1](#) discussed in [Section 6.10.5](#) can be used to preliminarily assess the FOS for these cases.

More detailed stability analyses, such as those mentioned in [Section 6.10.5](#), should be based on either the SPT or the Shelby tube data. No stability analysis is to be made on the basis of the pp data.

6.10.3 Analysis Based on SPT Data

Unless the presence of weak, soft soil layers is recognized during the initial drilling, the SPT data would be used to perform slope stability analyses. This data will include either shear strength derived from field Q_u tests, using the Rimac tester, performed on cohesive soil samples extracted from the SPT sampler; or N values, for cohesionless soils.

If upon analysis, using SPT data, the minimum FOS obtained is 1.5 or greater in fill areas, or 1.7 in cut slopes, the stability of the slope is considered satisfactory. If on the other hand, the minimum FOS is below 1.5 in fill areas, or 1.7 in cut slopes, the stability of the slope should be further investigated using Shelby tube boring data.

6.10.4 Analysis Based on Shelby Tube Data

As previously mentioned, Shelby tube borings and laboratory test data should be obtained to further evaluate fill slopes that have a FOS < 1.5 when using SPT data or cut slopes with FOS < 1.7. The Shelby tube data report should contain, besides soils classification, the lab Q_u values, and the triaxial shear strength data. To be acceptable, stability analysis based on Shelby tube data should yield a minimum FOS of 1.3 for embankments, and 1.5 for backslopes (in cut areas). If the FOS falls below 1.3, remedial measures should be used to bring the FOS of the slope to 1.3 or greater for embankments; and 1.7 or greater for cut slopes.

6.10.5 Discussion of Slope Stability Analysis

While a longhand analysis is very helpful in understanding the mechanics of sliding earth masses, such analysis is time consuming. Computer-aided procedures are available, and they provide a far more detailed analysis in less time.

There are also rules of thumb that can be used to make a preliminary assessment of the FOS to prevent failure. One such rule is:

$$\text{FOS} = \frac{6c}{\gamma H} \quad (\text{Eq. 6.10.5-1})$$

Where: c = cohesion of embankment soil

γ = unit weight of soil

H = Height of slope

The FOS computed using [Eq. 6.10.5-1](#) should not be used for final design. This simple equation can be used to preliminarily check both slope and foundation (base) stabilities.

For slope stability, [Eq. 6.10.5-1](#) is based on Taylor's (1937 and 1948) friction circle/limit equilibrium method of slope stability analysis, for c & ϕ soils. The analysis is based on total stresses, and assumes the cohesion is constant with depth (or uniform within the embankment). The factor (6), in [Eq. 6.10.5-1](#), is the stability number that corresponds to: 1) a cohesive soil with $\phi = 0$; 2) a slope angle of 25° to 45° (2H:1V to 1H:1V slope); 3) a shallow slip circle (a toe or slope circle); 4) a large depth, to hard layer (2H to 4H).

For base stability, [Eq. 6.10.5-1](#) is based on Terzaghi's bearing capacity equation for continuous footing on a cohesive soil ($\phi = 0$) at the ground surface; i.e. no overburden pressure. The factor (6), in this case, is approximately equal to the N_c value for $\phi = 0$ ($N_c = 5.7$). To be a little more conservative, it is advisable to use (5) instead of (6) in [Eq. 6.10.5-1](#). Thus, major movements in the embankment base may be expected, when the embankment height (H) approaches a value equal to $5c/\gamma$. In this case, c and γ are the average cohesion and unit weight, respectively, of the subsurface soils which support the embankment.

This rule of thumb ([Eq. 6.10.5-1](#)) can be helpful very early in the design stage to check if stability may be a problem, and if more detailed analyses should be performed. [Eq. 6.10.5-1](#) is the basis of [Eq. 3.4.4.3-1](#). [Eq. 3.4.4.3-1](#) can be used in the field while the boring and sampling is being done. These two equations can aid in redirecting the drilling, sampling, and testing program, if necessary, while the drilling crew is at the site. Therefore, [Eq. 6.10.5-1](#) will also help ensure that adequate strata are explored and sampled sufficiently. Finally, [Eq. 6.10.5-1](#) can be used to check for gross errors in computer output or input.

A large amount of information has been published on slope failures. A considerable amount of this information has been synthesized in chart form. Abramson et al. (1994) prepared stability charts that permit the user to approximate the critical fill height of a slope.

A number of slope stability methods of analysis have been adapted for use with a computer, and undoubtedly, there will be others in the future. The concern is whether or not the computer program represents the short-term and long-term conditions that exist in the field. For those analyses, the problem is described by a two dimensional slice, and the slice is typically thin (such as 1 ft. thick). The program should have the capacity to represent the actual site conditions, by inclusion of all forces acting on each slide. Some methods include the side forces on each slide, while other methods ignore these forces.

Currently, IDOT uses a computer program that utilizes simplified Bishop method, simplified and generalized Janbu method, Spencer method, and generalized limit equilibrium method. The program provides options for circular, non-circular and block surface search. Specific circular or non-circular surface can be selected for the rigorous generalized Janbu, or the generalized limit equilibrium methods.

In general, the simplified Bishop method is used at IDOT. A comparison between the simplified Bishop and simplified Janbu, for 34 project files, showed that the Janbu FOS exceeds the Bishop

FOS by an average of 8.5% and 4.5% in static and pseudo-dynamic analyses, respectively. The earthquake acceleration in the pseudo-dynamic analysis ranged from 0.1g to 0.3g. This data is based on IDOT's current policy of assuming a Q_u of 1 tsf for the embankment soil and a $\phi = 0$ (total stress analysis). The policy is based on IDOT's experience with a variety of borrow soils used in embankments.

Extensive triaxial testing was conducted on a variety of embankment soils compacted to 95% standard density (Illinois Modified AASHTO T 99) at the CBM's Soils Laboratory. Test results showed that most cohesive soils achieved a minimum Q_u of 1 tsf. In some cases, a Q_u greater than this value may be used in the analysis provided that: 1) the foundation soils and the embankment material are evaluated; 2) the *in situ* Q_u of the compacted embankment material is evaluated during construction; and 3) approval is obtained from the CBM on a case-by-case basis.

There will be occasions when a slide will develop. In order to resolve the problem of slope stability in the most favorable way, it will be necessary to have a detailed knowledge of the subsurface materials, conditions at the site, and the location of the sliding plane. This will require borings, or slope inclinometer installations, or pore water pressure information within the involved strata. When analyzing a slide area, the residual shear strength should be used for the layer(s) in which the failure surface has occurred.

6.10.6 (Reserved)

6.10.6.1 (Reserved)

6.11 Scour Evaluations and Countermeasure Treatments

Scour is the removal of streambed soils during major flood flow events. Theoretical scour magnitude evaluations are performed using Hydraulic Engineering Circular HEC-18 equations which were developed assuming the streambed is comprised of sand. These scour depths may be excessively deep in some non-granular streambed conditions since they do not account for increased scour resistance of these materials. Therefore, it is necessary for the geotechnical engineer to determine if the HEC-18 predicted scour is realistic considering both the streambed deposits at the pier and the service life of the structure. For silt, sand, and gravel deposits, these theoretical scour depths can be considered realistic and likely to occur over a 50 year life of a substructure. Although foundation soils consisting of clay, sandy or silty clay, glacial tills and even weak rock can scour to the same depths as granular soils, it takes a series of rain events that will never occur within the life of the substructure design and thus must be adjusted based on the site specific stratification, soil and rock type as well as strength.

At select sites where Shelby tube soil samples can be obtained near the pier, the Department's Erosion Function Apparatus (EFA) can be used to determine the erosion rate of cohesive soils and the theoretical scour depth can be re-calculated using the Scour Rate In COhesive Soils (SRICOS) analysis program. Contact the BBS Foundations and Geotechnical Unit or Hydraulics Unit to determine if this testing and analysis is appropriate on a case-by-case basis. In the absence of an EFA/SRICOS cohesive soil scour analysis, refer to Section 2.3.6.3.2 of the [Bridge Manual](#) for general guidance provided to assist the geotechnical engineer in making recommendations on reducing the theoretical, predicted scour depth at typical bridge locations with non-granular streambeds. These guidelines have been developed through ICT research and testing by the Department as discussed in [Straub et al. \(2013\)](#).

Once the theoretical 100 year and 200 year (strength and extreme limit state) scour depths have been adjusted by the geotechnical engineer to establish the design elevations, the effects of scour shall be taken into consideration in foundation design of bridges and 3-sided structures. Scour effects should not be applied to closed bottom culverts. In some instances, countermeasure treatments may be employed to reduce or mitigate the design scour depth. Countermeasures for scour typically include hard armoring such as riprap and gabion baskets. The design scour depths may or may not be permitted to be adjusted for armoring countermeasures depending on the application. For example, scour depths at bridge abutment end slopes are permitted to be adjusted for armoring, while scour depths are not permitted to be adjusted for armoring at the piers per FHWA hydraulic policy directives. Refer to Section 2.3.6.3.2 of the [Bridge Manual](#) and

[All Bridge Designers \(ABD\) Memorandum 14.2](#) for further discussion on scour considerations and design.

6.12 Seismic Analysis

Geotechnical engineers are generally responsible for reporting seismic design ground motion parameters and site response factors to the structural engineer for use in the seismic analysis and design of transportation structures. In addition, the geotechnical engineer is responsible for conducting seismic slope stability analysis and identifying potential geological phenomena such as liquefaction. Seismic analysis and design parameters should be evaluated and reported as discussed in the following sub-sections.

6.12.1 Seismic Evaluation and Design Recommendations

6.12.1.1 Applications

According to the AASHTO Seismic Acceleration Coefficient map of the Continental US, approximately the southern third of the State is the most seismically active area. This affects Districts 7, 8 and 9. The bedrock acceleration map for the State is shown in [Figure 6.12.2.2-1](#). This chart should be used to find the value of design bedrock acceleration, at a given site. AASHTO Specifications should be followed for seismic evaluations of a structure.

6.12.1.2 Seismic Loading

Seismic loadings depend on the bedrock acceleration at the site, modified by a site coefficient factor. The site coefficient factors listed in AASHTO are meant for structural analyses only. Site coefficient factors for geotechnical work, like slope stability and liquefaction, and earth pressures can be determined through analysis. One such analysis consists of performing a response spectral analysis, using a computer software program called "SHAKE". This analysis is required only for large projects, or when it is stated in the consulting agreements. For other structures, use a site coefficient of 1.0 for geotechnical analyses.

A minimum seismic FOS of 1.0 is acceptable for slope stability, sliding and overturning of a retaining wall, and for liquefaction. For bearing capacity, a minimum FOS of 1.5 is acceptable.

6.12.1.3 Remedial Treatments

Remedial treatments to mitigate seismic design deficiencies, in soils, should be considered where possible. The appropriateness of such treatments will depend on their cost. Whenever such problems arise, they should be brought to the attention of BBS for resolution.

6.12.2 Seismic Design Parameters for Structures

The seismic ground motion data to be reported by the geotechnical engineer varies by project and scope-of-work. The following information is provided to guide the geotechnical engineer in determining what seismic data is applicable to a project.

6.12.2.1 LRFD Seismic Parameters

All new bridges and three sided structures are required to be designed for a seismic event with seven percent probability of exceedance in 75 years which is approximately a 1000-year return period. This design criterion gives a low probability of collapse. However, a structure may suffer significant damage and result in possible disruption of service.

Seismic design for structures uses the horizontal force effects of earthquake loads. The seismic design parameters used include: Seismic Performance Zone (SPZ), Design Spectral Acceleration at 1.0 sec. (S_{D1}), Design Spectral Acceleration at 0.2 sec. (S_{DS}), and the Soil Site Class. These parameters shall be determined and reported in the SGR by the geotechnical engineer. They are derived according to Articles 3.10.2 thru 3.10.6 of the “AASHTO LRFD Bridge Design Specifications” ([AASHTO, 2020](#)) as discussed in the following sub-sections.

6.12.2.1.1 Soil Site Class Definition

For site characterization of seismic hazard parameters, sites are classified into one of six Soil Site Classes (A through F) as defined in Table 3.10.3.1-1 of the “AASHTO LRFD Bridge Design Specifications” ([AASHTO, 2020](#)). [Table 6.12.2.1.1-1](#) is a reprint of Table 3.10.3.1-1 and summarizes these categories, which consist of ranges of material stiffness based on shear wave velocity (\bar{v}_s) in the upper 100 ft. In the absence of shear wave velocity measurements, weighted averages of SPT blow counts (\bar{N}) and undrained shear strength (\bar{s}_u) data from soil borings may be used to establish a site’s Soil Site Class Definition. The procedure outlined in the Department’s “*Seismic Site Class Definition*” Design Guide and accompanying Excel spreadsheet titled

“Seismic Site Class” are available to assist geotechnical engineers in determining a site’s Soil Site Class Definition (See [Section 6.19](#)).

Soil Site Class	Soil Type/Profile
A	Hard rock: $\bar{v}_s > 5,000$ ft./sec.
B	Rock: $2,500$ ft./sec. $< \bar{v}_s < 5,000$ ft./sec.
C	Very dense soil and rock: $1,200$ ft./sec. $< \bar{v}_s < 2,500$ ft./sec., $\bar{N} > 50$ blows/ft., or $\bar{s}_u > 2.0$ ksf
D	Stiff soil: 600 ft./sec. $< \bar{v}_s < 1,200$ ft./sec., $15 < \bar{N} < 50$ blows/ft., or $1.0 < \bar{s}_u < 2.0$ ksf
E	Soil: $\bar{v}_s < 600$ ft./sec., $\bar{N} < 15$ blows/ft., $\bar{s}_u < 1.0$ ksf, or a profile with over 10 ft. soft clay (PI > 20 , w $> 40\%$, and $\bar{s}_u < 0.5$ ksf)
F	Soils requiring site-specific evaluations, including: <ul style="list-style-type: none"> • Peats or highly organic clays over 10 ft. thick • Very high plastic clays over 25 ft. thick and PI > 75 • Very thick soft/medium stiff clays over 120 ft. thick

Table 6.12.2.1.1-1 LRFD Seismic Soil Site Class Definition Categories

6.12.2.1.2 Design Spectral Acceleration Coefficients

For new bridges and three sided structures, the seismic hazard is characterized by the horizontal acceleration response spectrum using site specific procedures. This begins with obtaining the horizontal Peak Ground Acceleration (PGA) and the short- and long-period horizontal response spectral acceleration coefficients (S_s and S_1 , respectively) from the figures in Article 3.10.2 of the “AASHTO LRFD Bridge Design Specifications” ([AASHTO, 2020](#)) for a 1000-year return period. The PGA, S_s and S_1 , are then multiplied by site factors F_{pga} , F_a , and F_v , respectively, to develop the site specific design response spectrum coefficients A_s , S_{DS} , and S_{D1} as shown in [Eq. 6.12.2.1.2-1](#) thru [Eq. 6.12.2.1.2-3](#). [See also Article 3.10.4 of the “AASHTO LRFD Bridge Design Specifications” ([AASHTO, 2020](#))]. The site factors F_{pga} , F_a , and F_v are obtained from tables in Article 3.10.3 of “AASHTO LRFD Bridge Design Specifications” ([AASHTO, 2020](#)).

$$A_s = F_{pga} \times \text{PGA} \tag{Eq. 6.12.2.1.2-1}$$

$$S_{DS} = F_a \times S_s \tag{Eq. 6.12.2.1.2-2}$$

$$S_{D1} = F_v \times S_1 \tag{Eq. 6.12.2.1.2-3}$$

Where,

A_s = Design Spectral Acceleration at 0 sec.

S_{DS} = Design Spectral Acceleration at 0.2 sec.

S_{D1} = Design Spectral Acceleration at 1.0 sec.

PGA = Horizontal Peak Ground Acceleration coefficient on rock (Site Class B)

S_s = Horizontal response spectral acceleration coefficient at 0.2-sec. period on rock (Site Class B)

S_1 = Horizontal response spectral acceleration coefficient at 1.0 sec. period on rock (Site Class B)

F_{pga} = Site factor at zero-period (0 sec.) on the acceleration spectrum

F_a = Site factor at short-period (0.2 sec.) range of the acceleration spectrum

F_v = Site factor at long-period (1.0 sec.) range of the acceleration spectrum

Determining these general and site specific design response spectrum coefficients can be simplified by using a free USGS software on-line application titled “U.S. Seismic Design Maps” available at: <http://earthquake.usgs.gov/hazards/designmaps/usdesign.php>. When using this application, select the design code reference document “2009 AASHTO Guide Specifications for LRFD Seismic Bridge Design”. Then, input the Site Class Definition and project location (longitude and latitude) and compute. This application produces a “Design Maps Summary Report” in PDF format for ease in documentation. From this, the Design Spectral Acceleration at 0.2 second (S_{DS}) and 1.0 second (S_{D1}) may be obtained and reported in the SGR by the geotechnical engineer.

Critical structures and major river bridges are sometimes analyzed for a seismic hazard greater than a 1000-year return period (i.e., a 2500-year return period, etc.) and/or with ground motion data generated from a site specific analysis. Design ground motion data for these projects should be coordinated with the BBS on a project-by-project basis.

6.12.2.1.3 Seismic Performance Zone

Seismic Performance Zones (SPZs) are assigned to a site to establish a level of seismic risk which is used for structure design criteria. Rock with shear wave velocity ranging between 2,500 ft./sec. and 5,000 ft./sec. (Class B) is the base reference material used to generate the seismic horizontal acceleration coefficient figures provided in Article 3.10.2 of the “AASHTO LRFD Bridge Design Specifications” ([AASHTO, 2020](#)) for the 1000-year return period. Soil deposits generally have a propensity to amplify the surface ground motion requiring that modification factors be

applied to the data contained in these figures. The modification factors are determined using the Soil Site Class Definition ([Section 6.12.2.1.1](#)). Once the Site Class Definition is established and S_{D1} has been calculated ([Section 6.12.2.1.2](#)), the SPZ should be determined in accordance with Table 3.10.6-1 of the “AASHTO LRFD Bridge Design Specifications” ([AASHTO, 2020](#)). [Table 6.12.2.1.3-1](#) is a reprint of Table 3.10.6-1 and summarizes the Seismic Performance Zone categories.

Seismic Performance Zone	$S_{D1} = F_v S_1$ (1 Sec. Acceleration)
1	$F_v S_1 \leq 0.15$
2	$0.15 < F_v S_1 \leq 0.30$
3	$0.30 < F_v S_1 \leq 0.50$
4	$0.50 < F_v S_1$

Table 6.12.2.1.3-1 LRFD Seismic Performance Zones for 1000-yr. Design Return Period Earthquake

6.12.2.2 LFD Seismic Parameters

When required, the following data shall be given in an SGR for jobs when the planned level of seismic resistance to be provided is for the 500 yr. design return period earthquake according to the [AASHTO Standard Specifications](#) (LFD design): Seismic Performance Category (SPC), Horizontal Bedrock Acceleration Coefficient (A), and the Site Coefficient (S).

The evaluation of an existing bridge for potential seismic retrofitting will typically be performed using LFD criteria which analyzes ground motion data for a 500-year return period. For these structures, the geotechnical engineer should report the horizontal bedrock acceleration coefficient (A) defined in [AASHTO Standard Specifications](#) Div. I-A, Article 3.2. Refer to [Figure 6.12.2.2-1](#) for Illinois’ horizontal bedrock acceleration map with a 500-year return period. Occasionally, at the discretion of the Department, existing structures are classified as critical, and may be analyzed for a 1000-year return period which would require that the same data described in [Section 6.12.2.1](#) and its sub-sections for new bridges be reported.

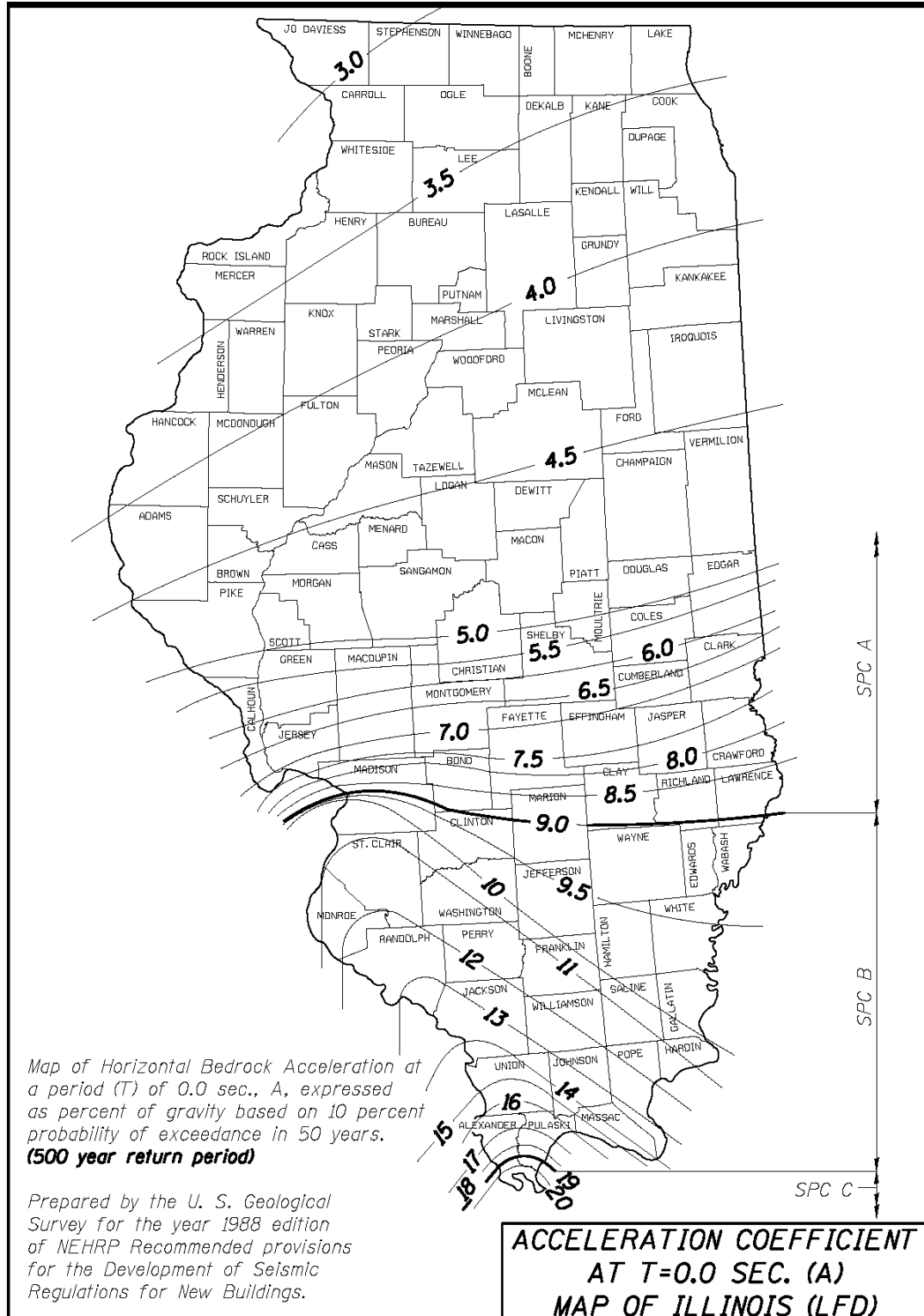

Figure 6.12.2-1 Horizontal Bedrock Acceleration Map for the State of Illinois (500-year Return Period)

For LFD projects, a similar evaluation of the site effects is required for ground motion data reported for the 500-year return period using the [AASHTO Standard Specifications](#) code. A Site Coefficient (S) should be reported using the soil profile definition provided in [AASHTO Standard Specifications](#) Div. I-A, Article 3.5 that best matches the geotechnical profile according to the boring logs. In addition, the Seismic Performance Category (SPC) should be determined in accordance with [AASHTO Standard Specifications](#) Div. I-A, Article 3.4. Structures should be considered “essential” when determining the SPC unless indicated otherwise by the planning engineer. Refer to [Figure 6.12.2.2-1](#) for a map of Illinois’ SPC zones.

6.12.2.3 (Reserved)

6.12.3 Seismic Liquefaction

Seismic liquefaction of soils is a phenomenon that occurs during a seismic event. The pore water pressure in a soil rises so rapidly, due to seismic excitation, that it significantly reduces the soil shear strength. Clean gravel and sand deposits, under the water table, are the most prone soils to undergo this phenomenon. However, a Chinese earthquake had silty deposits which experienced liquefaction.

The effects of seismic liquefaction under a structure can be very significant. It can produce loss of stability at a bridge endslope, settlement of bridge approaches, and loss of bearing capacity in piles or under spread footings.

Liquefaction does not mean the soil deposit loses its entire shear strength. Recent studies showed that under the worst conditions (clean sand below the water table) the residual shear strength, upon liquefaction, can be 30 to 40 % of its original value.

Since seismic liquefaction produces settlement of the material above the liquefiable zone (such as at bridge cones), pile negative skin friction loads must be considered. When required, geotechnical engineers should conduct an analysis to assess the FOS against liquefaction using the procedure presented in the Department’s “*Liquefaction Analysis*” Design Guide (See [Section 6.19](#)). An accompanying Excel spreadsheet titled “*Liquefaction Analysis*” has been prepared to assist geotechnical engineers with this procedure. If analysis indicates that the FOS’s against liquefaction are greater than or equal to 1.0 in all soil layers present, no further analyses are necessary. However, if there is a soil layer or layers indicating an FOS less than 1.0, the potential

for liquefaction along with the associated potential effects on a slope or foundation should be further evaluated.

6.12.4 (Reserved)

6.12.4.1 Seismic Slope Stability Deformations

If the seismic slope stability FOS falls below 1.0, the geotechnical engineer can estimate the vertical deformation or settlement at the back of the slope by using the Newmark procedure. This procedure is not valid if liquefaction is also identified under the slope. IDOT considers a maximum settlement of 6 in. at a bridge approach, resulting from the design earthquake event, to be acceptable without instituting corrective measures in the design.

6.12.5 (Reserved)

6.13 Foundation Type Selection and Analysis

For most applications, IDOT uses three types of foundations for highway structures: shallow foundations, piles, and drilled shafts. Occasionally, another foundation type called micropiles has been utilized. The following sub-sections discuss each of these foundation types.

6.13.1 Shallow Foundations (Spread Footings)

(This section is currently under development.)

[Sections 7.4.4](#) and [7.4.5.5](#) for contain guidance on reporting design recommendations for shallow foundations, and [Section 8.8](#) provides an overview of construction inspection guidelines.

6.13.1.1 – 6.13.1.6 (Reserved)

6.13.2 Pile Foundations

Driven piles are the most prevalent foundation type used by IDOT. Pile supported foundations are required to be designed for axial and lateral loading conditions. This section and following sub-sections provide guidance on pile foundation design and development of design recommendations.

An overview of the pile types used by the Department, and their common applications is provided in [Section 6.13.2.1](#). This is followed by some general guidance in [Section 6.13.2.2](#) for the geotechnical and structural engineers to keep in mind throughout the analysis and process of selecting pile type(s) and spacing(s).

Piles are subject to both axial and lateral loadings which need to be evaluated to determine the minimum required pile length and size which will support the loads both geotechnically and structurally while being cost effective. Axial loading is normally only evaluated for the Strength Limit State and Extreme Event Limit State loadings. The Service Limit State axial loadings are not typically evaluated due to the very low amount of pile settlement associated with piles driven according to IDOT [Standard Specifications](#). Evaluation of lateral loading on piles must consider the service deflection of the pile top and the factored bending moments to select the appropriate pile type and size. Further discussion on axial and lateral loading of piles is presented in [Sections 6.13.2.3, 6.13.2.4](#) and their sub-sections.

All piles under a foundation unit must be driven to the same capacity (nominal required bearing). Friction piles are only driven to the nominal required bearing needed to support the design loads. End bearing piles, however, are driven to their maximum nominal required bearing ([Section 6.13.2.3.1.2](#)). This practice develops additional capacity with minimal increase in pile length, which allows these piles to be reused if the design loads are increased during future superstructure rehabilitation.

In cases where friction piles are closely spaced and have a footing containing two or more rows, the pile group may have less capacity than the sum of the capacity of the individual piles in the group. These pile groups should be evaluated according to Article 10.7.2.3 of the “AASHTO LRFD Bridge Design Specifications” ([AASHTO, 2020](#)) for Service Limit State settlement and Article 10.7.3.9 for resistance of pile groups in compression for the Strength Limit State. Group action must also be evaluated when analyzing the lateral capacity of pile groups, which is discussed in [Section 6.13.2.4.2](#).

When designing a structure with integral abutments, refer to [Section 6.13.2.5](#) which addresses piles supporting integral abutments. Foundations for integral abutments have unique design challenges and limitations regarding their axial and lateral loads compared to most other types of substructures.

Lastly, [Section 6.13.2.6](#) discusses pile load testing. Pile load tests are rarely utilized by the Department due to the time it takes to run the test and their expense. However, on large projects, a pile load test can be used to reduce the size, length and number of piles used at the various substructures represented by the test when the cost/benefit is expected to result in savings greater than the cost of the load test.

6.13.2.1 Pile Types

The standard pile types used on Illinois highway structures are discussed below along with their advantages and limitations for various applications, which should be taken into consideration when selecting a pile type for a project.

Details for H-piles, metal shell piles, and precast concrete piles as well as details for splice alternatives, pile shoe and conical tip requirements, and other pertinent details are given in Base Sheets [F-HP](#), [F-MS](#), and [F-PC](#) developed by the BBS.

6.13.2.1.1 Steel H-Piles

Steel H-piles consist of hot rolled steel HP sections, manufactured in a wide range of sizes, with the flange width approximately equal to the web (ranging from 8 to 14 inches in depth). [Table 6.13.2.3.1.2-2](#) in the Maximum Nominal Required Bearing Section [6.13.2.3.1.2](#) lists the various H-pile sizes IDOT uses. H-piles have a relatively small cross sectional displacement of soil when driven and fall into the category of non-displacement piles. The larger H-piles sections have capacity to carry higher axial and lateral loads than all other pile types used by the Department.

Steel H-piles are most frequently used as end bearing piles when bedrock or other suitable end bearing material is reasonably close to the ground surface. On occasion, H-piles are selected when subsurface conditions indicate very hard layers or the presence of cobbles or boulders, which would have a greater risk of damaging other pile types. In these cases, bedrock may not be present and thus the pile is considered a friction pile. In some soil profiles, a soil plug may develop between flanges along some portion(s) of the pile causing some displacement and increase friction in these areas. Because of this phenomenon, it is more difficult to estimate the driven length required for a friction H-pile to reach plan bearing than the displacement piles used by the Department.

6.13.2.1.2 Metal Shell Piles

Metal shell piles commonly used by the Department usually consist of a 12 in., 14 in. or 16 in. diameter steel tube which is filled with concrete after driving. The steel tube is most commonly constructed by spiral welding process; however, a longitudinal weld may also be used to create the tube. There are several wall thicknesses available from various manufacturers; however, IDOT commonly uses only three different thicknesses in order to ensure availability. [Table 6.13.2.1.2-1](#) summarizes the wall thicknesses used for each pile size.

Pile Diameter (Outside):	12 in.	14 in.	16 in.
Wall Thickness(es):	0.25 in.	0.25 in.	0.312 in.
		0.312 in.	0.375 in.

Table 6.13.2.1.2-1 Metal Shell Pile Sizes

IDOT requires either a steel plate or conical tip to be welded to the bottom of a metal shell pile to maximize soil displacement and friction as well as to allow inspection for damage after driving. Once the pile has been inspected and determined to be free of water and damage, the pile is filled with unreinforced concrete. The exception to this is at an integral or stub abutment, where a 10 ft. long reinforcement cage is placed in the top of the pile to provide additional bending resistance and protection against shell corrosion. The shell wall thicknesses shown above have been selected to resist the anticipated driving stresses when driven to their maximum nominal required bearing. Once filled with concrete, the concrete bonds to the shell so that it functions compositely, and the structural engineer is responsible for selecting the appropriate size pile to carry the axial loading and lateral bending stresses.

Because of their closed bottoms, metal shell piles have a relatively high cross sectional area of displacement of soil when driven and are considered displacement piles. Displacement piles can densify the surrounding soils and develop more friction from soil displacement than an H-pile. This results in metal shell piles driving to shorter lengths than H-piles while developing an equivalent axial capacity. As such, metal shells are the preferred pile type for friction piles. Their estimated driven lengths are more reliable because the soil displacement volume is consistent compared to H-piles which may or may not have portions of the pile plug and displace soil.

There are cases which caution should be used when considering the use of metal shell piles. When estimated lengths for metal shells approach bedrock, the risk that the pile would drive deeper than estimated to reach capacity and be damaged by contact with the bedrock would warrant selection of another pile type. In addition, very hard soil layers, boulders, and other obstructions may also increase the risk for damage and may require increasing the diameter and/or the thickness of the shell or changing to another pile type, depending on the information indicated in the boring data. When increasing the diameter and/or thickness of the shell to withstand more challenging subsurface driving conditions, the nominal required bearing to be shown on the plans should be between 15% to 30% below the maximum nominal required bearing given in [Table 6.13.2.3.1.2-2](#) depending on the level of concern.

6.13.2.1.3 (Reserved)**6.13.2.1.4 Precast Concrete Piles**

A precast concrete pile is another type of displacement pile well suited for use in friction pile situations. The two types of precast concrete piles used by IDOT are a reinforced precast pile and a precast, prestressed pile. Precast concrete piles are cast with a 14-inch square cross section and utilize conventional reinforcement with longitudinal bars and spiral confinement reinforcement cage along the entire length of the pile. Precast, prestressed piles are similar in configuration to the conventionally reinforced concrete piles except that wire strands are held in tension as the pile is cast, instead of longitudinal reinforcement bars.

At pile bent pier locations where surface water is present (rivers, lakes, etc.), both precast pile types have the advantage over individually encased metal shells and H-piles in that they can be driven without cofferdams or temporary forms. The concrete cover over the reinforcement provides greater protection in corrosive soils or where exposed to water compared to steel H-piles and metal shell piles.

Splices or cutting to plan elevation can be problematic and, in some cases, are not allowed for either precast or precast, prestressed concrete piles. As such, there needs to be a high level of confidence in lengths that may be required, and extra length is generally added to the estimated length in order to lower the risk of needing to add an extension in the field. Extensions detailed on the precast pile Base Sheet [F-PC](#) may be added during construction when necessary to extend a pile for driving in order to achieve the required capacity.

When selecting a pile type, it should be noted that both types of precast concrete piles require special handling and storage, which is outlined in Article 512.08 of the [Standard Specifications](#), in order to protect against damage prior to pile driving. Precast concrete piles are less robust than precast, prestressed concrete piles. They are more susceptible to damage by mishandling ([Section 8.10.4](#)) and overdriving. Their lack of prestress limits the driving energy that can be used without creating tension cracks, which in turn limits the capacity they can develop. The soil profile should consist of relatively uniform medium strength materials which could be penetrated without causing damage to the pile. Precast, prestressed piles should be used in cases where concern exists for possible pile damage from shipping, storage, handling and driving. The more difficult subsurface conditions or the need for higher pile capacities would be other reasons for selecting precast, prestressed piles.

6.13.2.1.5 Timber Piles

Timber piles also fall in the category of displacement piles. Due to the limited strength of the timber, the maximum pile capacity that can be specified and driven without damage is much lower than other pile types. Thus, their use would be limited to relatively lightly loaded structures. The Department has used timber piles to support culvert wing walls, pile supported embankments over relatively soft soils to reduce settlement, dry land bridges over peat bogs, temporary structures and other suitable applications.

Timber piles are best suited for use in friction pile situations where soil profiles do not contain excessively dense or hard layers, which may damage the pile. Their use should be discouraged in situations which may produce brooming of the top of the pile or possible damage to the tip. In permanent applications, treated timber piles should be specified to preserve the wood integrity against rot, decay and insect damage (particularly in areas where they are not permanently submerged below the groundwater level). Untreated timber piles can be used in temporary applications or when the service life is not excessive (e.g., emergency repairs which will be replaced within a few months or years). The service life of a treated timber pile is often not considered to be as long as that of other piles. Thus, locations which may require a longer service life would prevent the use of timber piles and necessitate one of the other pile types used by IDOT.

When the soil profile and pile loading cause the estimated length to be 50 feet or greater, the use of timber piles is not recommended due to the limited availability of a single timber member of that length and the possibility of the pile driving longer than estimated. The use of timber piles is best suited when the soil profile provides a high level of confidence in the estimated lengths and extra length is generally added to the estimated length in order to avoid a splice.

Unlike steel pile splices, timber pile splices are generally much weaker in bending than the timber pile itself which is one reason for avoiding splices. Timber piles have a tapered diameter, ranging from 6 to 8 in. at the tip to between 11 and 20 in. at the butt (top). Thus, another challenge with splicing timber piles is finding a timber pile extension with a tip diameter that closely matches the driven butt diameter so that a proper splice can be made. Planned splices are not allowed to furnish the ordered pile length. However, if the pile does not reach its required bearing after the driving the full length, an unplanned splice can be used to drive additional pile length in order to achieve the required capacity.

6.13.2.2 General Pile Selection and Spacing Considerations

When selecting the pile type and size at each substructure on a project, ideally the same type and size would be used at all substructures. This allows excess pile lengths cut off (cutoffs) at one substructure to be used at other pile locations if they were to drive longer than anticipated. However, it may not be feasible or economical to use the same pile type and size at all substructures. The loadings at piers are typically higher than abutments, and the feasibility of using a particular pile type and size would depend on span lengths and pile spacing. However, Section 3.10.1.11 of the [Bridge Manual](#) states that "The designer shall make every effort to select a pile spacing at each substructure unit such that the ratio of the largest Nominal Required Bearing specified on a bridge to the smallest Nominal Required Bearing specified on a bridge not exceed 1.5. Keeping the Nominal Required Bearings at the various foundation elements within this range will help avoid the added expense of mobilizing more than one size pile hammer." Additionally, the SGR should include a note in the pile recommendations section advising the structural designer to consider hammer size(s), economics of using the same pile size, and the like when determining the nominal required bearing of the piles at the various substructures.

The minimum pile spacing per the [Bridge Manual](#) is 3 times the pile diameter for friction piles in order to avoid adjacent piles relying on the same soil for side resistance, which would reduce the capacity of each pile. Although this rule also applies to both friction and end bearing piles, in special cases, end bearing H-piles can be spaced more closely due to their lack of reliance on skin friction. As such, a smaller spacing may be approved after discussions with the Bureau of Bridges and Structures. At the time of SGR development, pile spacing is not usually known. However, the structural engineer will need to space the piles during the design phase such that the loadings and pile size are kept similar between the various substructures.

6.13.2.2.1 Reuse of Existing Pile Foundations

Early in the process in determining the scope of work to an existing bridge, the District must complete a Bridge Condition Report (BCR) and submit it to the bridge office for review and approval. One of the tasks involves evaluating the capacity of the existing substructures to determine if they can be reused. In some cases, the capacity of a pile as shown on the plans may underestimate the actual load carrying capacity given various site and driving information. A procedure was developed to calculate this capacity increase and is contained in the [Bridge Condition Report Procedures & Practices Manual](#).

The [BCR Procedures & Practices Manual](#) provides both an Abbreviated Analysis and a Detailed Analysis. The Abbreviated Analysis is utilized initially to determine if the pile can be reused without having to perform the more Detailed Analysis. The Abbreviated Analysis involves calculating the existing and proposed service dead load to check if the increase in dead load is less than 15% at the top of the substructure element. If the dead load increase is 15% or less, the pile(s) can be assumed to carry the future live and dead loads. However, if the increase in dead load is more than 15%, the Detailed Analysis will need to be conducted to determine if the pile can be reused. In the Detailed Analysis, the BCR author determines the factored pile loading using an Illinois Modified Group-1 load combination. Next, the procedure provides a method to evaluate the information known about the pile, the site, and (if available) information about the hammer used to drive the pile in order to determine the factored capacity of the existing pile. Lastly, a comparison is made between the factored pile loading and the factored resistance available to determine if the pile supported foundation can be reused. In cases where the pile capacity would appear to carry the factored load, the following issues may still preclude use of a pile:

- The structure is in an area with seismic categories C or D or seismic zones 3 or 4 per the "AASHTO LRFD Bridge Design Specifications" ([AASHTO, 2020](#)).
- The hydraulic analysis and soil conditions indicate substantial scour.
- Deterioration has compromised the structural integrity of the piles or footing.
- Inspections indicate past foundation settlement.
- There is a lack of redundancy (3 piles or less per foundation element).
- The increase in pile capacity or service bearing loading exceeds 50%.

The Detailed Analysis portion from the [BCR Procedures & Practices Manual](#) is also available as a Design Guide with a companion spreadsheet. Refer to [Section 6.19](#) for links to the Design Guide titled "Existing Foundation Load Carrying Capacity" and spreadsheet titled "Existing Pile Capacity".

6.13.2.3 Axial Resistance

Although both lateral and axial loading must be considered in determining the required pile size and length, in most cases, the axial loading controls the pile design. Piles transfer the axial load from a structure to the surrounding soil through a combination of side and end bearing resistance. Piles which derive the vast majority of their capacity at the pile tip (by bearing into bedrock or very dense/hard soils) are referred to as end bearing piles. The most common end bearing pile type used by IDOT are H-piles. Piles that are predominately supported by side resistance (which

develops from skin friction in granular soils and adhesion in cohesive soils) are referred to as friction piles. Metal shell piles are the most common type of friction piles used by the Department. Precast concrete and timber piles are other types of friction piles used, and H-piles can also be used in friction when hard layers or obstructions raise concern for damage of other pile types.

In the following sub-sections, guidance is provided for designing piles for axial resistance considering Strength Limit State and Extreme Event Limit State load groups, geotechnical losses, pile driving considerations, and other factors that may affect the pile type, size, spacing and length.

6.13.2.3.1 Nominal Required Bearing, Factored Resistances Available, and Estimated Length

Load and Resistance Factored Design (LRFD) of foundations requires that a structural designer evaluate two main limit states, which are the Strength Limit State and the Extreme Event Limit State. However, at the stage in the design process which the SGR is developed, the loadings are not known for these conditions, and the SGR author is tasked with providing pile capacities for these limit states for later use by a structural engineer. To accomplish this, pile design tables need to be developed for a range of possible loadings and lengths for the pile types and sizes being considered. The Service Limit State is rarely checked since the axial deflection is historically minimal when the Strength Limit State is satisfied.

Determination of the axial resistance of a pile first requires calculation of the “ultimate” bearing capacity for a given pile length, which is referred to as the **nominal bearing**. Once the nominal bearing of a pile has been established, the **factored resistance available** to carry the factored loads at that length is determined. The pile length used to determine the nominal and factored resistance is referred to as the **estimated pile length**. The structural designer must select an estimated pile length and corresponding nominal bearing which provide a factored resistance equal to or greater than the controlling factored pile loading from the structure.

The Department uses the **IDOT Static Method** to calculate the nominal and factored pile bearing resistances (R_N and R_F) as well as the corresponding estimated length. The following sub-sections describe how these geotechnical resistance values are calculated and should be presented in the SGR for use by a structural designer.

6.13.2.3.1.1 Nominal Required Bearing

The Nominal Required Bearing (R_N) represents the ultimate/nominal axial pile resistance expected at a given length considering side and tip resistance. The R_N shall be determined using the IDOT Static Method which utilizes the soil properties indicated in the soil boring logs for estimating side and tip resistance as a function of pile type and length. The IDOT Static Method has been utilized since the late 1960's and was modified to accommodate LRFD design in 2006. It was further refined and calibrated as a result of research conducted by the University of Illinois by [Long, et al. \(2009\)](#). Details of the IDOT Static Method are presented in the Design Guide titled "*Axial Geotechnical Resistance of Driven Piles* ([Section 6.19](#)) and discussed below.

The basic formula for calculating the nominal required bearing, R_N , is the sum of the side and tip resistance. However, there are some variations to the basic calculation based on if the pile is a displacement or non-displacement pile, if it has a plugged or unplugged condition, and the type of soil or rock.

Non-displacement piles, such as H-piles, initially drive through the soil, providing friction to the web and flanges with a limited amount of end bearing due to its small cross sectional area, which is considered an unplugged condition. As the pile drives deeper through certain soil types, the soil can become wedged between the flanges and web and move with the pile, causing it to act more like a displacement pile, which is considered a plugged condition. In this case, the end bearing increases due to the plugged cross-sectional end area, while the side resistance is reduced to the two outside webs and soil surfaces between the webs on either side of the pile. Since we do not know if or when a pile will plug, both the plugged and unplugged conditions must be checked to determine which provides the lower total pile resistance.

Displacement Piles: Piles such as metal shell, precast, and timber piles are considered displacement piles. For these piles, the R_N is calculated as follows:

$$R_N = (F_S q_S A_{SA} + F_P q_P A_P) * (I_G) \quad (\text{Eq. 6.13.2.3.1.1-1})$$

Where the nominal side resistance ($F_S q_S A_{SA}$) is the product of the following:

F_S = The pile type correction factor for side resistance:

- 0.758 for displacement piles in cohesionless soils
- 1.174 for displacement piles in cohesive soils

q_s = The nominal unit side resistance

A_{SA} = The surface area of the pile

I_G = Bias Factor Ratio, which is equal to 1.04 and discussed in [Section 6.13.2.3.1.3](#)

And the nominal tip resistance ($F_p q_p A_p$) is the product of the following:

F_p = The pile type correction factor for tip resistance:

- 0.758 for displacement piles in cohesionless soils
- 1.174 for displacement piles in cohesive soils

q_p = The nominal unit tip resistance

A_p = The tip area of the pile

I_G = Bias Factor Ratio, which is equal to 1.04 and discussed in [Section 6.13.2.3.1.3](#)

Non-displacement Piles: Piles with small cross-sectional areas, such as steel H-piles, are considered non-displacement piles. For these piles, the R_N shall be taken as the lesser of the following two equations for **piles in compression**:

The fully “plugged” side and tip resistance defined as:

$$R_N = (F_s q_s A_{SAp} + F_p q_p A_{Pp}) * (I_G) \quad \text{(Eq. 6.13.2.3.1.1-2)}$$

And the fully “unplugged” side and tip resistance defined as:

$$R_N = (F_s q_s A_{SAu} + F_p q_p A_{Pu}) * (I_G) \quad \text{(Eq. 6.13.2.3.1.1-3)}$$

Where:

F_s = The pile type correction factor for side resistance:

- 0.15 for non-displacement piles in cohesionless soils
- 0.75 for non-displacement piles in cohesive soils
- 1.0 for non-displacement piles in rock

F_p = The pile type correction factor for tip resistance:

- 0.3 for non-displacement piles in cohesionless soils
- 1.5 for non-displacement piles in cohesive soils
- 1.0 for non-displacement piles in rock

A_{SAu} = The unplugged surface area = (4 x flange width + 2 x member depth) x pile length

A_{SAp} = The plugged surface area = (2 x flange width + 2 x member depth) x pile length

A_{Pu} = The cross-sectional area of steel member

A_{Pp} = The flange width x member depth

I_G = Bias Factor Ratio, which is equal to 1.04 and discussed in [Section 6.13.2.3.1.3](#)

q_s = The nominal unit side resistance as determined by [Eq. 6.13.2.3.1.1-4](#) to [Eq. 6.13.2.3.1.1-24](#) and corresponding soil type or by the presumptive values for a given rock type listed under the “[Nominal Unit Side Resistance \(\$q_s\$ \) of rock](#)” (after [Eq. 6.13.2.3.1.1-24](#))

q_p = The nominal unit tip resistance as determined by [Eq. 6.13.2.3.1.1-25](#), [Eq. 6.13.2.3.1.1-26](#) and corresponding soil type or by the presumptive values for a given rock type listed under the “[Nominal Unit Tip Resistance \(\$q_p\$ \) of rock](#)” (after [Eq. 6.13.2.3.1.1-26](#))

For non-displacement steel H-piles required to carry **tension loads or uplift resistance**, pullout resistance shall be computed using the surface area assumption (A_{SAp}) for a “plugged” condition only. This calculation will provide the minimum tip elevation which must be specified on the plans ensure pullout resistance.

The Nominal Unit Side Resistance (q_s) and Nominal Unit Tip Resistance (q_p) shall be calculated as follows:

Nominal Unit Side Resistance (q_s) of granular soils is computed using the equations below:

For **Hard Till**, the equations below are used for the range of SPT N-values indicated:

$$q_s = 0.07N \quad \text{for } N < 30 \quad (\text{Eq. 6.13.2.3.1.1-4})$$

$$q_s = 0.00136N^2 - 0.00888N + 1.13 \quad \text{for } N \geq 30 \quad (\text{Eq. 6.13.2.3.1.1-5})$$

For **Very Fine Silty Sand**, the equations below are used for the range of SPT N-values indicated:

$$q_s = 0.01N \quad \text{for } N < 30 \quad (\text{Eq. 6.13.2.3.1.1-6})$$

$$q_s = 42.58e^{\left[\frac{(N-175.05)^2}{-7944}\right]} \quad \text{for } 30 \leq N < 74 \quad (\text{Eq. 6.13.2.3.1.1-7})$$

$$q_s = 0.297N - 10.2 \quad \text{for } N \geq 74 \quad (\text{Eq. 6.13.2.3.1.1-8})$$

For **Fine Sand**, the equations below are used for the range of SPT N-values indicated:

$$q_s = 0.11N \quad \text{for } N < 30 \quad (\text{Eq. 6.13.2.3.1.1-9})$$

$$q_s = 0.3256N + \frac{182}{N} - 12.51 \quad \text{for } 30 \leq N < 66 \quad (\text{Eq. 6.13.2.3.1.1-10})$$

$$q_s = 0.329N - 9.91 \quad \text{for } N \geq 66 \quad (\text{Eq. 6.13.2.3.1.1-11})$$

For **Medium Sand**, the equations below are used for the range of SPT N-values indicated:

$$q_s = 0.117N \quad \text{for } N < 26 \quad (\text{Eq. 6.13.2.3.1.1-12})$$

$$q_s = 0.00404N^2 - 0.0697N + 2.13 \quad \text{for } 26 \leq N < 55 \quad (\text{Eq. 6.13.2.3.1.1-13})$$

$$q_s = 0.356N - 9.1 \quad \text{for } N \geq 55 \quad (\text{Eq. 6.13.2.3.1.1-14})$$

For **Clean Coarse Sand**, the equations below are used for the range of SPT N-values indicated:

$$q_s = 0.128N \quad \text{for } N < 24 \quad (\text{Eq. 6.13.2.3.1.1-15})$$

$$q_s = 0.00468N^2 - 0.0693N + 2.05 \quad \text{for } 24 \leq N < 50 \quad (\text{Eq. 6.13.2.3.1.1-16})$$

$$q_s = 0.394N - 9.42 \quad \text{for } N \geq 50 \quad (\text{Eq. 6.13.2.3.1.1-17})$$

For **Sandy Gravel**, the equations below are used for the range of SPT N-values indicated:

$$q_s = 0.15N \quad \text{for } N < 20 \quad (\text{Eq. 6.13.2.3.1.1-18})$$

$$q_s = 0.00861N^2 - 0.217N + 3.91 \quad \text{for } 20 \leq N < 40 \quad (\text{Eq. 6.13.2.3.1.1-19})$$

$$q_s = 0.6N - 15.0 \quad \text{for } N \geq 40 \quad (\text{Eq. 6.13.2.3.1.1-20})$$

Nominal Unit Side Resistance (q_s) of cohesive soils, shall be calculated using the equations below for the range of Q_u values indicated:

$$q_s = \frac{-1}{2500} Q_u^3 - 0.177Q_u^2 + 1.09Q_u \quad \text{for } Q_u \leq 1.5 \text{ tsf} \quad (\text{Eq. 6.13.2.3.1.1-21})$$

$$q_s = 0.0495 Q_u^3 - 0.347Q_u^2 + 1.278Q_u - 0.068 \quad \text{for } 1.5 \text{ tsf} < Q_u < 2 \text{ tsf} \\ (\text{Eq. 6.13.2.3.1.1-22})$$

$$q_s = 0.470 Q_u + 0.555 \quad \text{for } 2 \text{ tsf} \leq Q_u < 4.5 \text{ tsf} \quad (\text{Eq. 6.13.2.3.1.1-23})$$

$$q_s = 2.67 \text{ ksf} \quad \text{for } 4.5 \text{ tsf} \leq Q_u \quad (\text{Eq. 6.13.2.3.1.1-24})$$

Where:

Q_u = Unconfined compression strength of the soil in tsf.

(Note that Q_u is input in tsf and q_s is output in ksf.)

If $Q_u > 3$ tsf and $N > 30$, treat as granular and use Hard Till equations.

Nominal Unit Side Resistance (q_s) of rock, shall be calculated using the values below for the type of rock encountered:

$$q_s = 12.0 \text{ ksf} \quad \text{for Shale}$$

$$q_s = 20.0 \text{ ksf} \quad \text{for Sandstone}$$

$$q_s = 24.0 \text{ ksf} \quad \text{for Limestone/Dolomite}$$

Note that actual pile penetration into rock is related to several factors including rock strength, degree of weathering, hammer energy and pile strength. The IDOT Static Method represents these by rock type, pile size, and nominal required bearing. The above empirical side resistance values, when used with the soil side resistance and rock tip resistance, provide a conservatively accurate representation of pile penetration into rock and thus total estimated pile length.

Nominal Unit Tip Resistance (q_p) of granular soils, shall be calculated as follows:

$$q_p = \frac{0.8ND_b}{D} \leq q_\lambda \quad (\text{Eq. 6.13.2.3.1.1-25})$$

Where:

$q_\lambda = 8N$ (for sands & gravel) or $6N$ (for fine silty sand & hard till)

D = Pile diameter or width (ft.)

D_b = Depth of penetration into soil (ft.)

N = Field measured SPT blow count (blows/ft.)

Nominal Unit Tip Resistance (q_p) of cohesive soils, shall be calculated as follows:

$$q_p = 9Q_u \quad (\text{Eq. 6.13.2.3.1.1-26})$$

Note that Q_u is input in tsf and q_p is output in ksf.

Nominal Unit Tip Resistance (q_p) of rock, shall be calculated using the values below for the type of rock encountered:

$q_p = 120.0$ ksf for Shale

$q_p = 200.0$ ksf for Sandstone

$q_p = 240.0$ ksf for Limestone/Dolomite

Note that actual pile penetration into rock is related to several factors including rock strength, degree of weathering, hammer energy and pile strength. The IDOT Static Method represents these by rock type, pile size, and nominal required bearing. The above empirical tip resistance values, when used with the soil side resistance and rock side resistance, provide a conservatively accurate representation of pile penetration into rock and thus total estimated pile length.

6.13.2.3.1.2 Maximum Nominal Required Bearing

Maximum Nominal Required Bearing ($R_{N\ MAX}$) is the maximum R_N value that can be specified on the plans which would be expected to avoid dynamic driving stresses large enough to cause damage to the pile. The value of $R_{N\ MAX}$ could be determined more accurately by use of a wave equation analysis, WEAP ([Section 8.10.6.2](#)) because it considers the site specific soils and driving equipment. However, since the actual hammer which will be used during construction is not typically known during development of an SGR, the $R_{N\ MAX}$ may be conservatively approximated using the empirical relationships shown in [Table 6.13.2.3.1.2-1](#).

Pile Type	$R_{N\ MAX}$ Empirical Formulas*
Metal Shell Piles	$0.85 F_Y A_S$
Steel H-Piles	$0.54 F_Y A_S$
Precast Piles	$0.3 f'_c A_g$
Timber Piles	$0.5 F_{co} A_P$
Where:	F_Y = yield strength of the steel (50 ksi) f'_c = compressive strength of concrete (4.5 or 5 ksi) F_{co} = resistance in compression parallel to grain (2.7 ksi) A_S = the steel shell cross-sectional area (in. ²) A_g = gross concrete cross sectional area of pile (in. ²) A_P = cross-sectional timber area at top of pile (in. ²)
* Does not apply to piles set in rock (See Section 6.13.2.3.5)	

Table 6.13.2.3.1.2-1 Empirical Relationships for the Maximum Nominal Required Bearing for Driven Piles

The values of $R_{N\ MAX}$ for each standard pile type using the empirical equations of [Table 6.13.2.3.1.2-1](#) are shown in [Table 6.13.2.3.1.2-2](#). This is an updated reproduction from the table shown in Section 3.10.1.2.1 of the [Bridge Manual](#), which has not yet been updated to reflect the increase in yield strength (from 45 to 50 ksi) currently specified in the [Standard Specifications](#) for metal shell piles.

Pile Type and Size	Maximum Nominal Required Bearing** (kips)
Metal Shell 12"φ w/0.25" walls	392*
Metal Shell 14"φ w/0.25" walls	459*
Metal Shell 14"φ w/0.312" walls	570*
Metal Shell 16"φ w/0.312" walls	655*
Metal Shell 16"φ w/0.375" walls	782*
Steel HP 8x36	286
Steel HP 10x42	335
Steel HP 10x57	454
Steel HP 12x53	419
Steel HP 12x63	497
Steel HP 12x74	589
Steel HP 12x84	664
Steel HP 14x73	578
Steel HP 14x89	705
Steel HP 14x102	810
Steel HP 14x117	929
Precast 14"x14"	265
Precast Prestressed 14"x14"	294
Timber Pile	153
* Using 50 ksi yield strength steel as specified in the Standard Specifications .	
** Does not apply to piles set in rock (See Section 6.13.2.3.5)	

Table 6.13.2.3.1.2-2 Maximum Nominal Required Bearing Values for Driven Piles

It should be noted that the $R_{N\ MAX}$ values shown in [Table 6.13.2.3.1.2-2](#) should only be used for driven piles. The $R_{N\ MAX}$ for piles set in rock can be larger because they are not subjected to high driving stresses. While the $R_{N\ MAX}$ values of driven H-piles is limited to 54% of its yield strength, the nominal capacity of piles set in rock is 100% of its yield strength. Additionally, piles set in rock use a more favorable resistance factor of 0.7 according to Article 6.5.4.2 of the "AASHTO LRFD

Bridge Design Specifications” ([AASHTO, 2020](#)) compared to 0.55 used for driven piles. Refer to [Section 6.13.2.3.5](#) for further discussion on piles set in rock for axial resistance.

6.13.2.3.1.3 Factored Resistance Available

Factored Resistance Available (R_F) represents the net long term axial factored geotechnical resistance available at the top of a pile to support factored structure loadings. It accounts for losses in geotechnical resistance that occur after driving due to scour, downdrag (DD_R), or liquefaction (Liq.), as well as resistance required to support downdrag loads (DD_L) and reflects the resistance factor used to verify in the field that the R_N has been reached. It is used by the structural engineer to ensure that the factored resistance of a pile for both the Strength and Extreme Event Limit States (which use different resistance factors) equals or exceeds the factored loads. The R_F shall be calculated using the following equation:

$$R_F = R_N(\phi_G) - (DD_R + \text{Scour} + \text{Liq.})(\phi_G)(I_G) - DD_L(Y_p) \quad (\text{Eq. 6.13.2.3.1.3-1})$$

Where:

- Scour = nominal side resistance (loss) of soil above the design scour elevation
- Liq. = nominal side resistance (loss) of soil within liquefiable layers
- DD_R = nominal side resistance (loss) of soil expected to settle > 0.4 in.
- DD_L = nominal side resistance (load) of soil expected to settle > 0.4 in.
- ϕ_G = Geotechnical Resistance Factor for the construction verification of R_N
- I_G = Bias Factor Ratio relating the IDOT Static Method to the construction verification method used.
- Y_p = the DD_L Load Factor for the downdrag soil loading on the pile

Applying the geotechnical resistance factor (ϕ_G) to the geotechnical losses may appear unconservative. However, the commentary in Article 10.7.3.7 of the “*AASHTO LRFD Bridge Design Specifications*” ([AASHTO, 2020](#)) advises that the factored loads ($R_F + Y_p DD_L$) be \leq the factored resistance below the downdrag layers. Thus, the pile must be driven to a R_N equal to the nominal downdrag resistance (DD_R) to install the pile through the downdrag layer plus $(R_F + Y_p DD_L) / \phi_G$ which results in both the geotechnical losses and R_N being multiplied by ϕ_G .

The nominal values of the downdrag (DD_R and DD_L), Scour, and Liquefaction (Liq.) shall be calculated using the IDOT Static Method side resistance equations provided above and as described below.

- Scour protection is provided by accounting for the loss in side resistance of soil layers above the design scour elevation in determining the R_F available to designers. The Scour term shall be taken as zero when calculating the R_F to resist Extreme Event I seismic loadings. Refer to [Section 6.13.2.3.2.1](#) for further guidance on scour.
- Downdrag is considered twice to represent the loss in side resistance (DD_R) and again to account for the added loading (DD_L) applied to the pile. The LRFD load groups specify that the portion of downdrag which applies a loading to the pile be included with loadings from other applicable sources. However, it is IDOT's policy to require that the downdrag loading (DD_L) and downdrag reduction in resistance (DD_R) for a pile be taken into account by the geotechnical engineer so it can be incorporated in the SGR pile design tables. Thus, they should not be included by the structural engineer in calculating the factored loadings. Refer to [Section 6.13.2.3.2.2](#) for further guidance on downdrag.
- Liquefaction is the loss of side resistance in layers expected to liquefy (Liq.) due to the design seismic event. Since liquefied soil of sufficient thickness consolidates, any non-liquefiable layers above such soils will settle and produce downdrag effects which must also be taken into account. Thus, in addition to Liq., losses from DD_R and DD_L for the layers above the liquefied soils shall be calculated and included in the R_F equation. However, Liq. and downdrag caused by liquefaction shall only be considered when calculating the R_F to resist Extreme Event I seismic loadings. Refer to [Section 6.13.2.3.2.3](#) for further guidance on liquefaction.

The values of geotechnical losses (Scour, DD_R , DD_L , and Liq.) for non-displacement steel H-piles shall be calculated using the surface area assumption, (A_{SAp} representing "plugged" conditions), regardless of whether the controlling value of R_N used "plugged" or "unplugged" side resistance.

Values for the Geotechnical Resistance Factor, Bias Factor, Bias Factor Ratio, and DD_L Load Factor shall be selected as follows:

- The Geotechnical Resistance Factor (Φ_G) shall be selected to represent the reliability of the method used in construction to verify that the R_N has been developed. Department

sponsored research summarized in [Long, et al. \(2009\)](#) studied both national and local static load tests and regional Pile Driving Analyzer[®] (PDA) dynamic tests ([Section 8.10.7](#)), and it indicated that a Φ_G of 0.55 should be used for the Strength Limit State to compute R_F if the WSDOT Pile Driving formula ([Section 8.10.6.1](#)) is specified for construction verification.

If it becomes clear during the planning process that earthquake forces may govern the pile design, the SGR pile tables should also indicate the R_F to support Extreme Event I Limit State loadings by setting the Φ_G to 1.0.

In load cases requiring piles to provide uplift resistance, the **factored tension** or **pullout resistance** of the pile shall be determined using the nominal side resistance equations provided in [Equations 6.13.2.3.1.1-1](#) and [6.13.2.3.1.1-2](#) (assuming the tip resistance is equal to zero) and applying a geotechnical resistance factor (Φ_G) of 0.20 for uplift under Strength Limit State loadings and 0.8 for uplift under Extreme Event I Limit State loadings in [Equation 6.13.2.3.1.3-1](#) to determine the factored resistance available to resist uplift forces. Refer to [Section 6.13.2.3.3](#) for more discussion on uplift.

The resistance factors for the Strength Limit State provided in Table 10.5.5.2.3-1 of the “AASHTO LRFD Bridge Design Specifications” ([AASHTO, 2020](#)) may be used when other construction verification methods are proposed, which include:

- For driving criteria established by the Wave Equation Analysis of Pile Driving (WEAP) program ([Section 8.10.6.2](#)) without pile dynamic testing or a load test but with field confirmation of hammer performance, a resistance factor of 0.50 should be used. However, this practice is not generally employed by IDOT since the resistance factor is less than that used with the WSDOT formula.
- For driving criteria established by dynamic testing using a PDA with signal matching ([Section 8.10.7.1](#)) of at least 2 piles, but no less than 2% of production piles, a resistance factor of 0.65 should be used.
- When dynamic testing with signal matching ([Section 8.10.7.1](#)) is performed on 100% of the production piles to establish the driving criteria, a resistance factor of 0.75 should be used.

- For driving criteria established by a static load test ([Section 8.10.7.2](#)) of at least one pile per site condition without dynamic testing, a resistance factor of 0.75 should be used.
- For driving criteria established by a static load test ([Section 8.10.7.2](#)) of at least one pile per site condition and dynamic testing with signal matching ([Section 8.10.7.1](#)) of at least 2 piles per site condition, but no less than 2% of the production pile, a resistance factor of 0.80 should be used.
- The Bias Factor Ratio (I_G) is the bias factor for the IDOT Static Method divided by the bias factor for the WSDOT dynamic formula ([Section 8.10.6.1](#)). A bias factor (λ_{IG}) is a statistical parameter that reflects the general tendency of a method (e.g., IDOT Static Method or WSDOT dynamic formula) to over or under-predict the nominal pile resistance when compared to the results of static pile load tests. Research indicates that the IDOT Static Method has a bias factor of 1.09, while the bias factor for the WSDOT dynamic formula used for construction verification is 1.05. As such, the I_G of these two methods is equal to 1.04 (1.09/1.05).

The Bias Factor Ratio is applied to the geotechnical losses (Scour, DD_R , and Liq.) to account for differences in bias between the IDOT Static Method (to estimate R_N) and the WSDOT dynamic formula (to verify the R_N in construction). It is used in the calculation for the nominal pile resistance (R_N) as shown in [Section 6.13.2.3.1.1](#).

- The DD_L Load Factor (Y_p) shall be equal to 1.05 for piles required to carry loads in compression. This value is based on the λ method load factor listed in Table 3.4.1-2 of the “AASHTO LRFD Bridge Design Specifications” ([AASHTO, 2020](#)). The side resistances estimated by the IDOT Static Method for cohesive and cohesionless soils is considered to be more consistent with the λ method than others listed in of the “AASHTO LRFD Bridge Design Specifications” ([AASHTO, 2020](#)). When a pile is required to provide pullout or uplift resistance, the DD_L Load Factor (Y_p) shall be equal to 0.30, which is the minimum value for the λ method load factor listed in Table 3.4.1-2 of the “AASHTO LRFD Bridge Design Specifications” ([AASHTO, 2020](#)).

An SGR should provide a range of Factored Resistances (R_F) available to use in the design, the corresponding Nominal Required Bearing (R_N), and the estimated pile length at which the R_N is expected to occur during driving as shown in [Table 6.13.2.3.1.4-1](#).

6.13.2.3.1.4 Estimated Length

The estimated pile length assumed for calculating the values of R_N and R_F , using the equations provided in [Sections 6.13.2.3.1.1](#) and [6.13.2.3.1.3](#), shall be provided in the SGR pile design tables. A pile design table shall be provided for each substructure, covering each applicable limit state. [Table 6.13.2.3.1.4-1](#) shows an example of a pile design table with the preferred order of information.

Pile design tables need to be provided for:

- Strength Limit State in all cases
- Extreme Event I when seismic loadings may be significant
- Extreme Event II (which includes the 200 year scour depth) when bridges span creeks, streams or rivers

The geotechnical engineer should contact the structural engineer to obtain the total preliminary factored vertical loading and proposed ground surface elevation at each substructure. In addition, the elevations for the bottom of the abutment cap, bottom of the pier encasement, and/or bottom of footing (which are typically the ground surface elevation adjacent to the pile during driving) as well as the pile cutoff elevations shall be obtained from the structural engineer and documented in the SGR. In some cases, such as an MSE wall abutment or when removal and replacement is required below a substructure, the ground surface adjacent to a pile during driving would be the bottom of the MSE wall or bottom of removal, respectively. This elevation should be documented in the SGR to identify when the pile design tables need to be changed if the final design elevation changes.

Pile Design Table for W. Abutment – Boring B-2			
SN: xxx-xxxx			
	Nominal Required Bearing (Kips)	Factored Resistance Available (Kips)	Estimated Pile Length* (Ft.)
Metal Shell 12"Φ w/.25" walls			
	295	123	57
	334	146	60
	392	179	62
Metal Shell 14"Φ w/.25" walls			
	315	128	52
	332	137	55
	349	147	57
	399	175	60
	459	210	62
Steel HP 10 X 57			
	269	116	60
	339	156	62
	341	157	65
	380	179	67
	454	250	74
Steel HP 12 X 53			
	287	120	57
	323	140	60
	416	193	65
	419	230	67
* Estimated pile length is based on an assumed pile cut off elevation of ___ ft. (accounting for the embedment depth of ___ ft. inside the substructure), a bottom of substructure elevation of ___ ft., and a ground surface elevation (where the soil begins contact with the pile) during driving of ___ ft.			

Table 6.13.2.3.1.4-1 Example Pile Design Table for SGRs.

For friction piles, the design tables must contain a range of R_N 's (and corresponding R_F 's for the given estimated pile lengths) for the pile types which, in the SGR author's judgement, can be driven without damage and used by the structural designer. The structural engineer will select an R_N and estimated length which provide the required R_F that is greater than or equal to the controlling factored load. The range of R_N 's, pile types, and sizes shall be broad enough to allow the structural engineer sufficient options for selecting a feasible and economical pile type, size and layout for the substructure type and design loads. The lower end of the range of possible R_F values, used in the pile design table, can be estimated by taking the total vertical factored substructure loading and dividing it by the width of the substructure (and the number of rows of piles) and multiply by the minimum pile spacing (3 times the pile diameter). The upper end of the range of possible R_F values can be obtained in a similar fashion as the minimum accept using a typical maximum spacing of around 10 feet or the $R_{N\ MAX}$ whichever is less. It is advisable to discuss this range of R_F values with the structural engineer to make sure that it provides sufficient options for flexibility in the foundation design to develop a cost effective pile group.

When bedrock or hard stratum are reasonably close, it may be apparent that an end bearing pile will be the most cost effective option. In these cases, the table would only include data for H-pile sizes since the other pile types would be greater at risk for damage. The pile design table would only provide the maximum nominal required bearing $R_{N\ MAX}$, factored resistance available R_F , estimated length to the anticipated tip elevation, and the end bearing material type. When estimating lengths of piles driven to rock, the penetration depth into rock is calculated considering the general engineering properties of the rock types typically found in Illinois. Although strength, RQD and recovery of the rock at the site is not considered for depth of penetration, lower bound values are assumed in order to estimate a pile length slightly longer than will be necessary for the production piles in most cases.

When it is not clear whether a friction or end bearing pile would provide the most cost effective foundation, pile design table will need to include both friction and end bearing choices as well as multiple pile types. The displacement friction piles in the table would only need to be provided to a depth of approximately 15 to 20 feet above bedrock to reduce the risk of damage from encountering bedrock if the pile driving were to run long or from the bedrock elevation being higher than shown in the boring. For non-displacement H-piles, the table can provide values for pile lengths approaching bedrock as well as end bearing values using the $R_{N\ MAX}$.

The pile design table typically should show the relationship between R_N and pile penetration expected as the pile is driven from the footing/substructure excavation elevation through the soil layers (and in some cases into bedrock) for each feasible pile type at every substructure. To provide an incrementally increasing range of bearing values, the soil profile is divided into smaller layers (2.5 to 5 ft. thick) which typically correspond to the SPT sample intervals. This allows the SGR author to assume an estimated pile length extending to the bottom of each soil layer and provides an R_N which includes the cumulative side resistance of all layers above and the tip resistance of the layer below. The structural engineer should use the controlling factored loading and interpolate between the incremental R_F values to determine the corresponding nominal required bearing R_N and estimated length to be shown on the plans.

The estimated pile length contained in the design tables (and shown on the plans) shall include the portion of the pile which will be incorporated in the substructure abutment, footing, MSE wall or solid wall pier encasement. As the development of the substructure design progresses, it is important that the structural engineer or geotechnical engineer identify when elevations and other assumptions have changed from those documented in the SGR and adjust the pile design tables as needed.

6.13.2.3.2 Geotechnical Losses

Geotechnical losses are the reduction in axial geotechnical resistance of a pile after driving due to natural phenomenon which may occur during the design life of a structure. The three losses that are required to be accounted for include scour, downdrag, and liquefaction. They are mathematically represented in the general pile capacity [Equation 6.13.2.3.1.3-1](#). The following sub-sections discuss each of these sources of geotechnical loss in greater detail.

6.13.2.3.2.1 Scour

Scour causes a geotechnical loss in pile capacity through removal of soil and corresponding side friction which needs to be accounted for in the pile design. Since the theoretical scour depths shown in the hydraulic report assume a sand soil type, the site specific soil type needs to be evaluated at each substructure to determine if a reduced scour depth can be used. Scour and soil type adjustments are discussed in [Section 6.11](#).

The geotechnical loss from scour is determined by subtracting the factored side resistance of the soils within the scour depths from the total factored geotechnical resistance (prior to scour). This is reflected in [Equation 6.13.2.3.1.3-1](#). The net pile capacities during the 100 year and 200 year return period scour depths need to be determined and compared to the Strength Limit and Extreme Event II Limit State loadings, respectively, in order to determine which one controls the design at each substructure.

The 100 year scour depth almost always controls even though the 200 year extreme event scour depth is almost always 5 to 15 percent deeper than the 100 year event. This is because the Strength Limit State uses larger factored loads and smaller factored geotechnical resistance than the Extreme Event II Limit State even though the 200 year scour depth is deeper. However, in cases where a pile is end bearing on relatively shallow rock and has adequate axial capacity, the Extreme Event II Limit State can control if the deeper 200 year scour reduces lateral support enough to cause the pile to become unstable. In these cases, piles may need to be set in rock (see [Sections 6.13.2.3.5](#) and [6.13.2.4.2.2](#)), or the foundation type can be changed to drilled shafts with rock sockets. However, when the predicted scour is so deep that the pile section capacity is insufficient to carry the unbraced loading, other foundation types may need to be considered such as drilled shafts or large diameter open ended piles.

6.13.2.3.2.2 Downdrag

Downdrag is a negative skin friction load applied to the upper portion of a pile due to downward movement of the adjacent soil relative to the pile. Downdrag loading becomes a concern when more than 0.4 inches of downward soil movement along the pile is anticipated after driving. Most downdrag occurs due to consolidation of foundation soils induced by additional loads applied from embankment or other surcharges. In this case, it should be accounted for under the Strength Limit State load group. (Refer to Section 3.10.1.5.2 of the [Bridge Manual](#) for additional discussion of downdrag loading.)

Downdrag can also occur due to the consolidation of liquefiable soils which is discussed in [Section 6.13.2.3.2.3](#). This type of downdrag load is only applied to a pile when evaluating the Extreme Event I Limit State pile loading.

There are several strategies to address downdrag. Selection of which method(s) are most appropriate depends on the magnitude of the downdrag, the estimated time for consolidation to occur, the depth to bedrock, the depth and thickness of the consolidating soils, and other factors (e.g. cost and time). Methods to consider for addressing downdrag include:

- **Waiting Period:** New embankment or placement of additional embankment on the side(s) or top of an existing embankment can cause settlement in excess of 0.4 inches. When consolidation testing indicates most of the settlement (< 0.4 inches remaining) is expected to be completed within a relatively short time (typically less than 90 days), a special provision can require a contractor to refrain from pile driving until after the settlement appears to be near completion. This option is preferred, when possible, since it addresses both settlement and downdrag, and results in the least expensive solution when time permits.
- **Surcharging the Embankment:** Upon completion of the embankment construction, an additional load can be specified to be applied to an embankment in order to accelerate the settlement process to allow pile driving sooner. The surcharge can be applied through various means such as adding additional earth fill to the top and sides of the embankment, placing precast concrete blocks on the top of the embankment, or a combination of both. This option may be considered for sites where the specified surcharge can be applied within a reasonable amount of time (without creating stability issues) in order to accelerate consolidation so that the remaining estimated settlement is less than 0.4 inches. (Refer to [Section 6.4.4.4](#) for additional discussion on surcharge.)
- **Removal and Replacement:** If the consolidating soils are relatively shallow, it may be cost effective to remove and replace the soil with another material (e.g. earth embankment, rockfill, light weight fill, etc.). If rockfill is selected, sand should be placed in the area where the piles will be driven to avoid damage during installation. For light weight fill materials (EPS and cellular concrete), sleeves need to be placed at each pile location to allow the pile to pass through the material without disturbing it. For additional guidance on removal and replacement methods, refer to [Sections 6.4.4.1](#) and [6.4.4.2](#).

- **Grading Contract:** For new alignments where a substantial amount of settlement is expected to occur over one or more years, it may be advantageous for some projects to be constructed over a series of 2 or more contracts. In these cases, the new embankment(s) are built in the first contract called a grading contract, and the bridge(s) and pavement are constructed in the subsequent contract(s). One advantage to this staged approach is that time is allotted for the majority of the settlement to occur prior to constructing the pavements and bridges. This approach would be effective in not only addressing downdrag, but settlement of approach pavements and other related infrastructure elements. This approach is most applicable for new roadway alignment construction, and it is rarely used as it requires advanced coordination with the District bureau of Program Development for appropriate planning and programming.
- **Increasing Pile Size and Length:** Another design strategy for addressing the effects of downdrag is to increase pile size and nominal resistance to carry the additional downdrag load. This is a common strategy on shorter piles bearing in rock. Friction piles also require a longer pile length (in addition to a larger size) which can make this approach less cost effective compared to other methods depending upon the magnitude of the loading and overall pile length.
- **Precoring:** When piles are driven through embankment which is expected to settle and cause downdrag, the downdrag may be addressed by driving piles through holes drilled in the embankment at the pile locations. The void between the pile and cored embankment is filled with loose, dry sand which is assumed to not apply any downdrag load to the pile. This process is known as precoring, and it would be considered where a waiting period is not an option due to the time to complete settlement exceeding that practical for the construction. The limits of the precore elevations must contain soil that can support itself until driving and backfilling is completed. This only mitigates downdrag load along the length of the precore hole, and soils below that level may settle and apply downdrag load. Due to equipment limitations, deep precoring is not always possible and those locations may use precoring to reduce the amount of downdrag load or lend themselves to another downdrag mitigation method. This strategy may not work well with battered piles because the sand may be pressed into the pile and apply downdrag and bending forces. Refer to [Section 6.13.2.3.4.4](#) for detailed guidance on precoring.

- **Sleeves:** When a new bridge cone or an MSE wall are anticipated to create settlement in excess of 0.4 in. after pile installation, piles can be installed, and sleeves placed around them prior to embankment or wall construction to shield the pile from the development of downdrag loading. Sleeves can consist of any material suitable to remain intact during fill placement and compaction. Similar to precoring, the sleeves are filled with sand after the embankment or wall erection approaches the top of the pile. This strategy may not work well with battered piles because the sleeve and sand may be pressed into the pile and apply downdrag and bending forces.
- **Applying Bitumen Coating:** Applying a bitumen coating to the piles can reduce downdrag. However, it has the disadvantage of only reducing the downdrag load by an estimated 50%. Another disadvantage is that unless the pile is driven prior to embankment placement, it is difficult to ensure that the proper part of the pile is coated such that in the final driven condition the coated part is in the soil layers which are anticipated to cause downdrag. Although other states may use this method, it is seldom used in Illinois. Use of this method would require a special provision, which is available through the FGU.

6.13.2.3.2.3 Liquefaction

Geotechnical losses from liquefaction occur when a seismic event generates a horizontal acceleration large enough to generate excess pore water pressure to the point where the effective soil shear strength reaches zero, resulting in the loss of side resistance along a pile. In addition to the loss of side resistance within the liquefiable layer, non-liquefiable layers above may settle due to consolidation of the liquefiable layer(s) and result in an additional loss due to downdrag loading. This downdrag loading is considered as part of the geotechnical loss due to liquefaction. As such, the loss of side resistance due to liquefaction and any corresponding downdrag load should be evaluated under the Extreme Event I Limit State load group. (The general topic of liquefaction and its analysis are discussed in [Section 6.12.3.](#))

Typically, the foundation configuration developed to satisfy the Strength Limit State loads is then checked to determine if it is adequate to carry the Extreme Event Limit State loadings. When the foundation design is found to be inadequate for the Extreme Event Limit State case, some additional measures may be considered which are as follows:

- Add a sufficient number of additional piles to provide the structural capacity as well as required vertical and lateral geotechnical resistance to carry the Extreme Event I Limit State loads during the liquefaction event.
- Change foundation type to drill shafts or other foundation types which have more capacity to carry the additional loads caused by the Extreme Event I Limit State.
- Prevent liquefaction by either compaction or chemical grouting these liquefiable soils surrounding the pile group. In the case of chemical grouting, the piles would have been driven first. For compaction grouting, the pile may be driven after the grouting as long as the piles can avoid the compaction grout columns.
- Conduct ground improvement to densify the loose soils through methods such as a vibro probe, deep dynamic compaction, aggregate columns, and alike.

6.13.2.3.3 Uplift Resistance

The pile configuration at a substructure typically results in a compressive load being applied to all of the piles for the Service and Strength Limit States. However, some load combinations may require some of the piles within a substructure to resist an uplift (tension) force. Although this can occur when checking the Strength Limit State, this most commonly occurs in the Extreme Event I - Seismic Loading or Extreme Event II - Barge Impact Loading with 200 year scour.

The procedure for estimating the factored geotechnical uplift (or pullout) resistance for the Strength and Extreme Event Limit States using the IDOT Static Method is covered in the Design Guide titled "*Axial Geotechnical Resistance of Driven Piles*" ([Section 6.19](#)). This Design Guide provides the uplift geotechnical resistance factors and the IDOT Static Method side resistance equations which are used to determine the uplift capacity. The uplift resistance factor for the Strength Limit State (0.2) is much lower than the compression loading resistance factor (0.55) due to the fact that the uplift capacity cannot be verified in the field during construction in the same way that the compressive capacity can. Similarly, the Extreme Event Limit State(s) uplift resistance factor (0.8) is also lower than the compressive resistance factor (1.0).

For non-displacement steel H-piles, pullout resistance shall be computed using the surface area assumption (A_{SAp}) for a “plugged” condition only. This calculation will provide the minimum tip elevation which must be specified on the plans to ensure pullout resistance as discussed in Section 3.10.1.4 of the [Bridge Manual](#).

When uplift is occurring in a design, the minimum tip elevation required to provide the necessary uplift resistance (pullout capacity) must be shown in the SGR pile design recommendations so that it can be included in the contract plans “Pile Data” to make sure the length assumed in the uplift capacity calculations is installed in the field.

The connection of a pile to a footing in uplift cases requires additional attention by the structural engineer since the standard pile embedment into the footing of 12 inches is not considered strong enough to withstand tension loadings. To increase the tension capacity, the embedment can be increased to 24 inches or shear studs (or hooked reinforcement bars) can be welded to the top of the pile. These additional connection details cause pile heads to be considered fixed into the footing, which also impacts the lateral load behavior of the piles.

Factored geotechnical uplift resistance is not normally provided in an SGR since the final pile configuration and loadings are not known. It is most commonly recognized during the structure design phase that some piles may need to carry uplift forces, and it is recommended that geotechnical engineers calculate the factored geotechnical uplift resistance as noted above when requested by the structural engineer.

6.13.2.3.4 Pile Driving Considerations

In addition to evaluating the various pile types and sizes that are feasible, the SGR should discuss other considerations including test piles and the need for pile shoes and conical tips. If downdrag is a concern, the option of precoring should also be discussed. On rare occasions, the SGR author may need to discuss pile setup and/or relaxation. It is imperative that the SGR author evaluate the various soil borings across the site and recommend appropriate pile type(s) and size(s) which minimize the risk of pile damage while considering cost. The following sub-sections provide more detailed guidance on each of these topics.

6.13.2.3.4.1 Test Piles

Test piles are specified at substructures when the geotechnical engineer anticipates that the driven length may vary substantially from the estimated length based on a number of factors for a given project. To assess this variability, the test piles are driven prior to driving production piles in order to allow the RE to determine the order length of the production piles at a substructure. This sub-section provides guidance on developing recommendations for test pile usage. Construction practices for test piles discussed in [Section 8.10.5](#) should also be considered when developing recommendations. Several factors should be evaluated when determining if test piles are required and which substructures should contain test piles. These factors include:

- **Cost:** Test piles are typically much more costly than production piles, but their use and expense can be justified when a risk exists for added costs due to excessive cutoff lengths or unplanned splices. These risks can be assessed considering the topics below and other project specific factors. Additionally, substructures with a large number of piles have the potential to benefit more from the use of a test pile than a substructure with relatively few piles. When considering costs, also bear in mind that the test pile usually replaces one of the production piles at a substructure.
- **Subsurface conditions:** High variability in subsurface conditions between the project borings at the various substructures creates uncertainty in the estimated lengths and would necessitate the use of test piles at each substructure. Conversely, uniformity in subsurface site characteristics can often allow test piles to be used at every other substructure. In some cases with extreme uniformity, even fewer test piles can be specified based on engineering judgement.
- **Boring proximity to substructures:** An additional source of uncertainty occurs when a boring is not located close to a substructure. In these cases, the estimated length may not be as accurate and may necessitate the use of a test pile.
- **End Bearing verses Friction piles:** H-piles end bearing on bedrock are least likely to require a test pile. When the bedrock elevation is relatively consistent between borings and borings are located close to the substructure, test piles are not normally needed. Conversely, friction H-piles need a test pile at most, if not all, substructures (dependent upon consideration of the other factors) because their pile length is the most difficult to accurately estimate. Metal shells displacement piles derive their capacity mainly from

friction, and thus a test pile is almost always needed. The number of test piles would be dependent upon consideration of the other factors (e.g., site variability, etc.).

- **Variability in plan bearing between substructures:** Where there is a large difference in nominal required bearing shown on the plans (plan bearing) between adjacent substructures, a test pile placed at the substructure with the higher plan bearing may be used to determine the ordered length at the substructure with a lower plan bearing. This should only be done when the soil profile at the lower bearing substructure is similar to the profile at the test pile.
- **Use of multiple pile types/sizes:** Although it is not common, the design may require different pile sizes or pile types be used at a bridge. Since a metal shell will drive shorter than a friction H-pile, a test pile for each would likely be necessary. Even a 14-inch metal shell pile will drive somewhat shorter than a 12-inch metal shell and may require a test pile for each size. Different size H-piles will drive slightly different, but often do not need the use of a test pile for each size unless they are significantly different (e.g., HP 10 verses an HP 14).
- **Variability in the footing/abutment elevations:** When there are substantial elevation differences between the ground surface from which the pile is being driven, the soil profile that the pile will be driven through will be different and necessitate the use of more or strategically located test piles.

An example of this is an abutment and an adjacent pier. On a three-span structure, often one test pile can be specified at the abutment with the longest estimated length (and also used to represent the other abutment) while a test pile can be located at the pier farthest away from the first test pile (to represent the adjacent pier).

- **Existing test and production pile driving records:** When this data is available and the pile type is similar, it can be used to increase confidence in the estimated length and justify not using a test pile at a given substructure. An existing test pile record can only be used when the new pile bearing is less than the test pile bearing. In the case of existing production pile data, the new pile bearing would need to be similar to the average existing driven bearing indicated on the record. This data is also very useful when evaluating the variability of bedrock surface elevations.

The following scenarios illustrate how the geotechnical engineer could evaluate the need for a test pile utilizing the above factors:

- In cases with borings showing consistent top of rock elevations, the borings are located very close to every substructure, and end bearing H-piles are planned to be used; the pile length may be estimated with sufficient confidence to avoid using any test piles.
- Some sites may warrant a test pile at each substructure particularly when borings are not close to the substructure, the soil properties between the borings are highly variable, no rock was encountered, and friction H-piles are utilized.
- The previous two cases represent extreme conditions that make the decision on selecting the number and locations of test piles relatively easy. However, it is more common that some of the factors noted above are present while others are not. In these instances, project cost could be reduced by specifying a test pile at every other substructure or strategically selected substructures in order to apply the test pile results at adjacent substructures. In some cases, the geotechnical engineer may also choose to add some additional pile length (5 to 7 ft.) to mitigate risk of the piles running longer than estimated and avoid unplanned splices as well as the test pile expense. This adds additional expense, but it should be less than the cost of specifying a test pile.

The geotechnical engineer needs to evaluate the various factors discussed above, make a recommendation for use (or lack of use) of a test pile at each particular substructure in the SGR, and document the reasoning behind the recommendation.

6.13.2.3.4.2 Site Conditions

One important consideration when recommending using driven pile foundations is evaluating the level of risk for causing damage to a pile during driving. This may be particularly important when a boring indicates hard layers, boulders, and buried obstructions. Some options to reduce the risk of pile damage during driving include precoring, increasing the pile size, changing the pile type, and reducing the maximum nominal required bearing below that shown in Table 3.10.1.2.1-1 of the [Bridge Manual](#) (which would reduce the hammer size and energy being imparted into a pile).

Timber piles are considered the least likely to handle the hammer energy and tip stresses which can occur in difficult driving conditions. Metal shells can be inspected for damage after driving and prior to filling with concrete; however, they are known to be susceptible to damage in very hard layers and deposits containing boulders. Precast piles are generally not used in hard driving soil profiles due to their susceptibility to cracking, and they cannot be inspected below grade after driving and are selected to minimize risk in corrosive soil environments. H-piles are considered the most robust pile type, and they are selected for end bearing on bedrock or for use to minimize the risk of pile damage in difficult subsurface conditions when used as a friction pile.

When the geotechnical engineer has some level of concern for pile damage during driving, it should be documented in the SGR along with the reasoning for the concern and outlining the specific measures which should be taken in design or construction to mitigate them.

6.13.2.3.4.3 Pile Shoes and Conical Tips

Pile shoes and conical tips are most often used with H-piles and metal shell piles, respectively, to facilitate driving and protect piles from damage. In most soil profiles, piles can be successfully driven without shoes or conical tips; however, some subsurface conditions warrant their use. The SGR author is tasked with reviewing the boring data to identify any conditions which could be cause for concern during pile driving. (For more discussion on pile damage, refer to [Section 8.10.4.](#))

When possible cobbles/boulders are noted often in the description column on the boring log(s), or when very high blow counts (which may suggest the presence of boulders) are located sporadically throughout the boring depth, the use of pile shoes or tips may be appropriate. Several other examples are outlined below to illustrate conditions where pile shoes and conical tips should be used.

- **H-Pile Shoes:** In some cases, pile shoes are used with H-piles to bite into sloping bedrock surfaces. In cases where strongly battered piles are being used or when piles are driven to a sloping bedrock surface, tips are added to keep the pile toe from traveling laterally along the rock surface which could cause unwanted bending in the pile. Additionally, an H-pile not driven perpendicular to the rock surface runs the risk of bending the flanges upwards as they encounter rock first before the rest of the pile. These concerns are particularly pronounced when hard rock such as limestone or dolomite is encountered as

opposed to a softer rock such as shale which the tip can penetrate much easier without concern for overstress or lateral movement of the tip.

- **Metal Shell Pile Conical Tips:** Metal shells are normally driven with a flat bottom steel plate to keep soil and water out of the pile interior so that the pile can be inspected for damage after driving. A conical tip can be welded to the pile in place of the plate to allow a pile to more gradually enter into hard or dense layers utilizing the cones larger surface area and shape in order to avoid an abrupt overstress that would occur with a plate. A pile driven with a flat plate could also encounter cobbles or hard layers which would load the plate non-uniformly causing overstress to one side of the pile shell. The 60° angle cone pushes aside the soil and cobbles which allows the stress to be more uniformly delivered to the shell.

In some cases, the use of shoes and tips may allow a pile to penetrate farther than piles without them. This is thought to be due to the tip being slightly larger than the pile which requires the soil to rebound back against a pile before it can provide side resistance. However, IDOT assumes that piles will drive the same length with or without tips and shoes since this effect is not currently quantifiable to include in pile length estimates.

When the geotechnical engineer believes that pile shoes or conical tips are required, it should be documented in the SGR along with the reasoning behind the recommendation.

6.13.2.3.4.4 Precoring at Pile Locations

Precoring is the removal of soil (and in some cases rock) at a pile location using either a standard soil auger or a continuous flight auger, prior to driving the pile. Precoring is specified by the designer to address various situations which are summarized below:

- To allow a pile to be driven past hard layers or buried obstructions without damage.
- To reduce or mitigate the loss of capacity due to settlement and the development of downdrag loads on a pile.
- To allow the use of integral abutments when the average soil strength below the abutment is too stiff and would cause pile overstress due to lateral movements caused by thermal expansion/contraction.

Precoring should be avoided when substantially thick granular layers or soft cohesive soils are present within the depth of precore as they are likely to collapse during drilling and driving prior to backfilling. When the obstruction or hard layers are relatively shallow, precoring can be accomplished relatively economically by use of solid stem augers and commonly available excavator equipment. As the depth of required precore increases, more specialized equipment, such as a continuous flight auger with leads, is needed which increases cost. The maximum depth of precoring may be considered to be around 30 feet.

The SGR author needs to provide the recommended hole diameter and bottom elevation of the precoring, and the designer needs to specify them on the plans. The hole size depends upon the size and shape of the piles along with the purpose for specifying precoring. When oversized precore holes are specified, the type of material used to backfill the holes needs to be specified by the designer based on the application. It is recommended that common auger diameters (12 in., 18 in., 24 in., etc.) be specified when selecting the precore diameter.

To avoid pile damage during driving due to anticipated obstructions (timbers, existing footings, buried pavements, boulders, etc.) or hard layers, precoring is commonly specified as opposed to full removal of the obstruction or layer. In the case of obstructions, the diameter of the precore hole needs to be large enough to allow a pile to pass by the obstruction and permit placement of loose, dry sand so that it completely fills the annulus. For cases when hard layers need to be precored, the hole diameter selected should be just large enough to allow the flange tips of an H-pile to fit within the precore diameter and backfill the remainder of the core hole with sand. When metal shells are used, the diameter of the precore hole should be equal to or larger than the metal shell pile. Using the precore diameter equal to the pile diameter allows the pile to develop some skin friction from the adjacent soils and avoids needing to fill the annulus with sand. Precoring a larger diameter (oversized) hole causes a pile to drive longer and requires the void to be backfilled with sand in order to maintain the lateral load capacity.

Precoring is one method to address negative skin friction (downdrag) which may be more economical than other alternatives discussed in [Section 6.13.2.3.2.2](#). This is accomplished by precoring down to an elevation where soil settlement adjacent to the pile is estimated to be less than 0.4 inch. In some cases, it may not be practical to extend the precore to the depth where the settlement is equal to or less than 0.4 in., precoring to a shallower depth may be used to reduce the amount of downdrag load to tolerable levels. When precoring to address downdrag, the hole needs to be larger than the pile diameter/diagonal in order to avoid contact with the settling

soils and large enough to permit sand dropped into the void between the pile and the settling soils.

Precoring is also specified at integral abutments when the soil strengths are too stiff to accommodate lateral movement from the anticipated thermal expansion of the superstructure. In these cases, the diameter of the hole must be large enough to accommodate the anticipated amount of lateral deflection and backfilled with a material which provides lower lateral soil resistance. Backfilling with sand or other aggregate is not recommended as the movement of the pile into the sand causes densification and results in transferring load through the sand to the stiffer soils outside the precore diameter, which prevents the pile movement required for this abutment type. Sodium bentonite is most commonly used to fill the voids around the pile after driving and provides the necessary elasticity to allow the required pile movement. A project special provision shall be included in the contract to address details of the bentonite material and construction requirements, and this special provision is available through the BBS.

For additional information on precoring, refer to [Section 8.10.3](#).

6.13.2.3.4.5 Pile Setup and Relaxation

The long term pile axial capacity is often greater than the capacity (nominal driven bearing) measured at the end of driving (EOD). This increase in capacity is referred to as pile setup which is the gain in pile capacity over time that occurs mainly due to dissipation of pore water pressures and healing of the disturbed and remolded soils immediately surrounding the pile. The magnitude of soil setup tends to vary according to pile type as well as soil type and strength/density properties. A greater magnitude of soil setup is generally expected for soft clays, dense granular deposits, and displacement type piles than for stiff clays, loose granular deposits, and non-displacement type piles.

Some state DOT's account for setup in the design process when the amount of setup can be accurately estimated. For IDOT projects, setup is not currently accounted for in the design process due to two factors. First, IDOT does not have enough information about the amount of setup that is likely to occur in the various deposits throughout the state to make this prediction. Further, the amount of predicted setup would need to be verified in the field which may create time delays during construction. Secondly, not using setup in the design phase allows setup to be used during construction, as discussed in [Section 8.10.6.1](#), in the event that a pile does not achieve the required bearing after driving the full furnished length. After a waiting period,

construction can direct the contractor to redrive (restrike) the pile in order to verify that it has setup enough to obtain the required bearing.

Relaxation is the opposite of setup where the capacity decreases after the end of drive. Piles driven into some shales can experience relaxation. Dense gravel dominated deposits are known to also exhibit relaxation. This is a relatively rare occurrence in Illinois; and to date, relaxation has not affected IDOT structures. If relaxation is anticipated to occur, the factored resistance available of the pile can be reduced by the amount of relaxation anticipated to address this concern.

6.13.2.3.5 Piles Set in Rock

Piles are most often specified to be set in rock when the strength and depth of soil above bedrock is insufficient to carry the lateral design loads as discussed in [Section 6.13.2.4.2.2](#). However, setting piles into rock can also be utilized for increasing the axial pile capacity above that allowed for a driven pile.

The design diameter and depth of the rock socket is sized to carry both the axial and lateral loads. The axial loads are resisted by side resistance along the length of the socket and the end bearing capacity of the rock at the base, similar to a drilled shaft. The socket diameter should be specified in 6-inch increments and be just large enough to allow a pile to be placed into the socket with sufficient room to permit placement of concrete such that it completely encases the pile. With the diameter established, the socket length can be increased until the side and tip resistance are sufficient to carry the axial load. Once the minimum socket length required to carry the axial load is established, the socket should be checked to determine if it adequately carries the lateral load (or vice-versa). If necessary, the socket length can be increased to carry the lateral load.

The design axial capacity of a pile set in rock can be larger than the maximums allowed in the [Bridge Manual](#) for driven piles. This is because piles set in rock are not subjected to high driving stresses, which limit the maximum nominal capacity of driven piles. The maximum nominal capacity of driven H-piles is limited to 54% of its yield strength, while the nominal capacity of piles set in rock is 100% of its yield strength. Additionally, piles set in rock use a more favorable resistance factor of 0.7 for non-driven undamaged piles according to Article 6.5.4.2 of the "AASHTO LRFD Bridge Design Specifications" ([AASHTO, 2020](#)) compared to 0.55 used for driven piles, where the nominal driven bearing is determined with the WSDOT dynamic formula.

When setting piles into rock is specified on the plans, a special provision ([GBSP 56](#)) should be provided in the contract documents. Refer to [Section 8.10.8](#) for guidance on construction inspection and installation.

6.13.2.4 Lateral Resistance

Although pile foundations primarily support vertical loads, almost all piles must also carry some level of horizontal loading. Lateral loads develop from wind, water, traffic braking, earth pressure, vehicular impact, vessel (barge) impact, and/or seismic forces applied to the superstructure and/or substructures. Lateral resistance of pile foundations is a function of the pile length, moment of inertia, diameter, and connection to the footing/substructure as well as the pile batter (if any) and the soil strengths along the length of a pile.

While the lateral load carrying capacity of a battered pile can easily be calculated based on its angle and vertical loading, computer programs such as L-pile, AllPile or RSPile are often needed to evaluate the soil-structure interaction and determine the lateral capacity of a pile. This capacity may need to be reduced for group action when piles are closely spaced and the movement of one pile effects the capacity of an adjacent pile. The computer programs can determine the maximum pile moment and pile head deflection as well as the necessary pile length and size to carry the required lateral load.

When evaluating the lateral load carrying capacity of short piles supporting structures such as noise walls, light towers and traffic signals, the Department uses the Brom's method. The Department has a Design Guide titled "Brom's Overturning & Torsion Capacity of Short Single Shaft" and corresponding spreadsheet ([Section 6.19](#)) available to assist in evaluation of laterally loaded piles and drilled shafts. However, the Brom's method is not considered accurate enough to be used for evaluating piles supporting bridge and retaining wall foundations.

Since the final lateral loadings are not known with certainty during the SGR development, an SGR can only provide preliminary analyses using assumed pile sizes and preliminary lateral loadings. This is often presented in graph form as the relationship between lateral loading verses maximum moment and pile head deflection to allow the structure planner to assess foundation feasibility considering estimated lengths, pile types and sizes available. However, as a minimum, the SGR shall provide the soil parameters necessary to perform a lateral analysis.

Although preliminary lateral analyses can be done during the planning (SGR) phase, most of the analyses are done during the structure design phase. When checking the Strength Limit States, the structural engineer typically assumes a pile size and spacing to establish the lateral loading per pile. They also assume a depth to fixity to calculate the maximum moment in a pile in order to verify the assumed pile size. The calculated lateral load and moment applied to the top of a pile are often provided to the geotechnical engineer to determine the relationship between lateral loading versus deflection and moment. Using this relationship, the geotechnical engineer can back calculate and provide the structural engineer with a revised depth to fixity by utilizing the soil properties and the selected pile type and size. When checking Extreme Event I Limit State (seismic loading), the final loads at each substructure are a function of foundation stiffness, which requires multiple iterations until the fixity depths used by the structural engineer provide the same deflection and moment as indicated in the geotechnical analysis.

In addition to establishing the pile size and configuration to carry the applied loads, it may also be necessary to establish the minimum pile length necessary to resist the lateral loading. In these cases, the contract plans should specify a minimum tip elevation to which the piles must be installed with the pile data information on the substructure sheets. When bedrock is relatively close to the surface, the minimum tip elevation may be below the anticipated driven penetration depth into rock. In these cases, the rock may need to be cored so that piles can be set into the rock and backfilled with concrete to carry the lateral loads. Refer to [Section 6.13.2.4.2.2](#) for further discussion on piles set in rock for lateral loading.

Geotechnical losses (such as scour and liquefaction) along with lateral seismic loading and tall retaining walls with high lateral earth pressures can pose a particular challenge when designing for the lateral load. When the lateral loads result in excessive deflection or pile overstress, the pile size can be increased, piles can be added to reduce the lateral load per pile, or additional batter angle can be considered. However, if the moment of inertia of a pile is still insufficient to carry the lateral load, drilled shafts will likely need to be used.

6.13.2.4.1 Battered Piles

A battered pile is a pile which is driven on a non-vertical alignment in order to provide a lateral force to resist lateral loads from a structure that it supports. Typically, battered piles are driven on a slope between 1/2-inch per foot to as much as 4-inches per foot. Use of batter angles larger than this can cause difficulties in maintaining pile alignment and produce uncertainties in the

computed capacity (due to inefficiencies created from the ram not being able to free fall in the hammer sleeve generating friction and other energy losses) which are difficult to quantify.

Structure designers typically try to use battered piles as the sole means to resist the lateral loads. This is due to the simplicity of computing the lateral force available from a battered pile as compared to the more involved soil-structure interaction analyses. In cases where battered piles are unable to carry the entire lateral load, designers must also analyze the soil-structure interaction of a pile to carry the remaining load ([Section 6.13.2.4.2](#)). Battered piles also offer the benefit of providing lateral resistance without significant deflection while the capacity available from a soil-structure interaction analysis requires significant pile deflection.

The use of battered piles on bridges required to carry seismic loads is discouraged. This is due to the increased foundation stiffness caused by battered piles which results in more seismic loading being carried by these substructures. Section 2.3.10.1 of the [Bridge Manual](#) states that "Piles in regions of high seismicity (LRFD SPZ 3 and 4, or LFD SPC C) should not be battered. For bridges in LRFD SPZ 2 (LFD SPC B), the specification of pile batter should be considered on a case-by-case basis." In some cases, the use of vertical piles and soil-structure interaction to carry the entire lateral loading is not feasible due to either excessive deflection or high moment in a pile, which may require some battering of the piles.

The structure designer selects the batter angle necessary by determining the applied horizontal foundation loading and then computes the vertical loading on each pile. By incrementally increasing the batter angle of selected row(s) of piles, a final pile batter angle configuration can be selected which produces sufficient total horizontal force equal to the applied horizontal loading. Since the vertical component of a pile must stay constant and equal to the applied vertical loading, driving the pile at a batter angle requires the force along the axis of the pile to be larger than the vertical pile load. The load along the axis of a pile is computed by dividing the vertical pile loading by the cosine of the batter angle. Then, the horizontal component of the batter pile is computed by multiplying the force along the axis of the pile by the sine of the batter angle.

Note that even if battered piles happen to be driven to a higher bearing than specified on the plans (due to the RE driving additional length for added safety or when a pile is driven to refusal on rock), the lateral force available to resist horizontal loads is limited by the actual vertical force applied to a pile.

6.13.2.4.2 Soil-Structure Interaction Analysis

Soil-structure interaction analysis involves applying a series of structure loadings (lateral force, moment, and axial force) to the top of a pile, causing it to deflect into the adjacent soils along the length of the pile. The structural capacity of a pile to resist flexure together with the lateral passive pressure of the soil, developed due to the pile deflection, work together to produce lateral capacity referred to as the soil-structure interaction capacity of a pile. Article 10.7.3.12 of the "AASHTO LRFD Bridge Design Specifications" ([AASHTO, 2020](#)) discusses the nominal lateral resistance of pile foundations.

The portion of lateral resistance related to a pile's structural capacity to resist bending is related to its material properties, size and geometry. In the case of a steel H-pile, its moment of inertia, yield strength and modulus of elasticity define the flexural behavior of the pile. Metal shell piles also consider these properties, but they must also have the concrete inside the shell transformed into additional equivalent steel since concrete acts composite with the steel. Similar properties and procedures would need to be followed when analyzing timber and precast concrete piles.

The geotechnical portion of the lateral resistance is directly related to the passive pressure mobilized in soil. This passive pressure is dependent upon several parameters including the soil type, shear strength, effective unit weight, strain corresponding to one-half the principal stress difference (ϵ_{50}), and the static or cyclic linear soil modulus (k_s or k_c). These parameters must be determined for each soil layer along the length of the pile. As a pile begins to deflect, the soil reacts by applying a pressure computed using the linear soil modulus (k_s or k_c) and the specific pile deflection. After exceeding the linear capacity of the soil, it provides additional resistance with increasing strain in a non-linear behavior. The unit weight, friction angle, cohesion, and ϵ_{50} define the soil resistance at any deflection after exceeding the linear capacity of the soil. This relationship between pile/soil deflection and passive pressure applied to the pile is referred to as the non-linear P-y spring curve of the soil, where "P" is in dimensions of load/area (pressure) and "y" is in length of pile deflection. The COM624P reference manual provides typical values for ϵ_{50} , k_s and k_c based on undrained shear strength in the case of cohesive soils and relative density of granular soils ([Wang and Reese, 1993](#)).

Due to the complex interaction between the pile flexure and non-linear soil springs, it is virtually impossible to determine by hand calculation the final pile deflection and corresponding soil pressure that occurs along the length of a pile, due to the applied loads. There are several

software programs available (such as L-pile or COM624P) that were developed specifically for analyzing laterally loaded piles and pile groups using what is referred to as the P-y method.

Unlike a battered pile which is able to provide lateral resistance with very small deflections, the P-y method always results in some deflection of the pile head. When the required additional lateral load needs are relatively small, deflections are often small enough not to impact the performance of the structure being supported. As the pile loading increases, so does the pile head deflection, which requires the structural designer to make sure that the foundation and structure being supported has the ability to tolerate the calculated deflection.

Piles typically only have 12 inches of embedment into most footings, pile caps and substructures, which is typically assumed to be a pinned connection. A pinned connection allows the pile head to rotate freely without resistance when loaded laterally. In cases where pile head deflections are excessive, the pile head connection to the substructure or footing can be fixed to reduce the calculated deflection and moment. This can be done by embedding the pile a minimum of 24 inches or using a detail as shown in Figure 3.15.5.5-1 of the [Bridge Manual](#).

Since the structural engineer performs the P-y analysis in the design phase (after the TS&L and SGR are completed) when the loads are known, the geotechnical engineer typically provides just the recommended soil properties at each substructure in the SGR for future use. It is recommended that the geotechnical engineer coordinate with the structural engineer during preparation of the SGR regarding the extent of information needed for lateral pile soil-structure interaction analysis.

The final pile spacing is also unknown during the SGR development, which limits the amount of assistance provided on how to handle pile group action. Group action occurs when piles are spaced close enough to each other that the passive pressure from one pile deflection reduces the passive pressure available to support an adjacent pile. Lateral group action is discussed in Article 10.7.2.4 of “AASHTO LRFD Bridge Design Specifications” ([AASHTO, 2020](#)). AASHTO recommends using a P-multiplier method which reduces the passive pressure by multiplying the P in each P-y curve by a coefficient that is less than 1.0 based on the spacing between adjacent piles and the number of rows. Most programs, such as L-pile, evaluate the capacity of a single pile unaffected by group action, but have the option to utilize the P-multiplier method to evaluate the effect of group action based on the specific pile spacing and rows used.

During the design phase, the depth to pile fixity for moment and deflection must be assumed by the structural engineer. Programs such as L-pile can be used to back calculate these depths which change as the loading changes. In addition, piles that are relatively short may not fully develop fixity, and they would need to be driven deeper or, in the case of end-bearing piles, socketed into bedrock. Coordination between the geotechnical engineer and structural engineer is recommended to properly determine the necessary pile depth to provide adequate support to the structure. The following sub-sections provide guidance on these analyses.

6.13.2.4.2.1 Pile Fixity Depths

The structural engineer models the superstructure, substructure, and foundation elements using programs such as MDX, Larsa, MIDAS and SAP. These programs are unable to model the non-linear spring behavior of soil like the P-y method programs can, thus the soil pressure supporting the pile must be modeled using a point of fixity. A point of fixity is a location at some depth into the ground below the substructure or footing where the pile deflection and rotation are assumed to be zero.

Typically, the structural engineer will initially estimate the point of fixity by assuming a depth of ten feet (or using other rules of thumb) to determine the loads going to each pile and select an appropriate pile size. Then, she/he can provide the pile loads to the geotechnical engineer, who then conducts a series of analyses using the P-y method for a range of lateral loads (both higher and lower than those provided by the structural engineer) for the pile type(s) and size(s) used in the structural engineer's initial analysis. The resulting maximum moments and deflections allows the geotechnical engineer to back calculate a fixity depth for moment and a second fixity depth for deflection of each load case.

To back calculate the depths to fixity, the top of pile head condition must be assessed to determine if it should be modeled as either a free-fixed (free pile head case) or fixed-fixed (fixed pile head case). Using the selected pile head assumption and the corresponding simplified beam theory equation, the moment fixity depth can be determined by solving for the length which gives a maximum moment equal to that determined by the P-y method. Similarly, the deflection fixity depth is the length at which the deflection obtained using the simplified beam equations equals the P-y method deflection. The depths to moment fixity and deflection fixity are very rarely to never equal. [Figures 6.13.2.4.2.1-1](#) and [6.13.2.2.4.1-2](#) show the relationships between the P-y method soil-pile interaction and the simplified beam equations for maximum moment and deflection of a free pile head and fixed pile head condition, respectively.

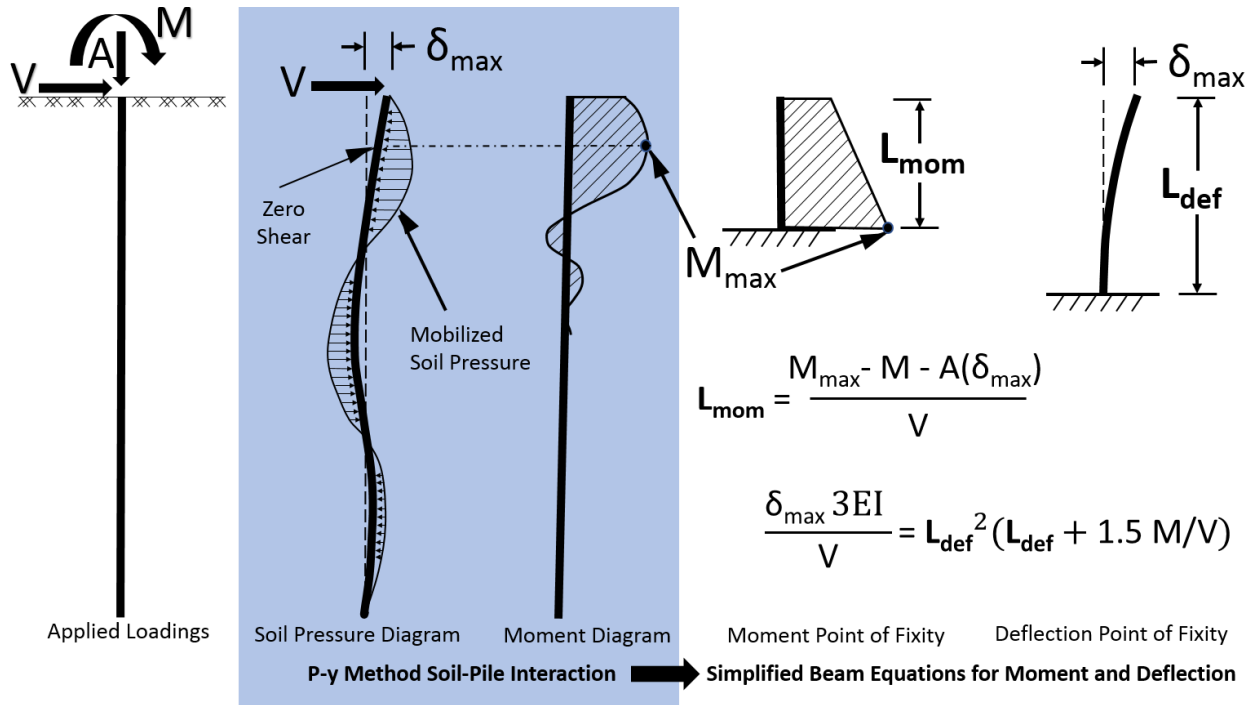

Figure 6.13.2.4.2.1-1 Relationship between the P-y Method and the Simplified Beam Equations for the Free Pile Head Case

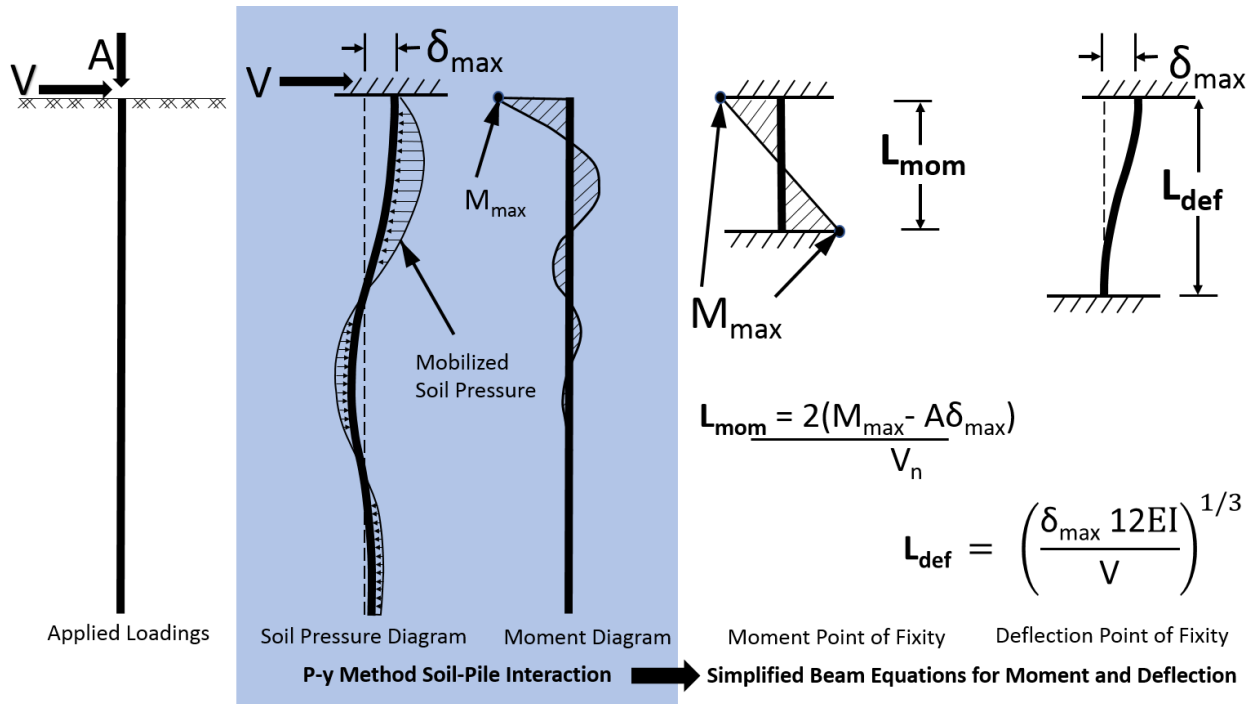

Figure 6.13.2.4.2.1-2 Relationship between the P-y Method and the Simplified Beam Equations for the Fixed Pile Head Case

In cases where piles are very short or have limited embedment below the design scour depths, the length of the pile may not be long enough to assume a point of fixity will exist. To assume a point of fixity will exist, the pile length must be longer than the critical pile length. The critical pile length is determined by re-running the P-y method analysis using a long pile length and successively shortening the length until the pile head deflection begins to increase. The length at which the pile head deflection begins to increase is known as the **critical pile length**. The graph in [Figure 6.13.2.4.2.1-3](#) illustrates an example of a series of P-y method analyses which plot the various pile lengths and corresponding pile head deflections to identify the critical pile length.

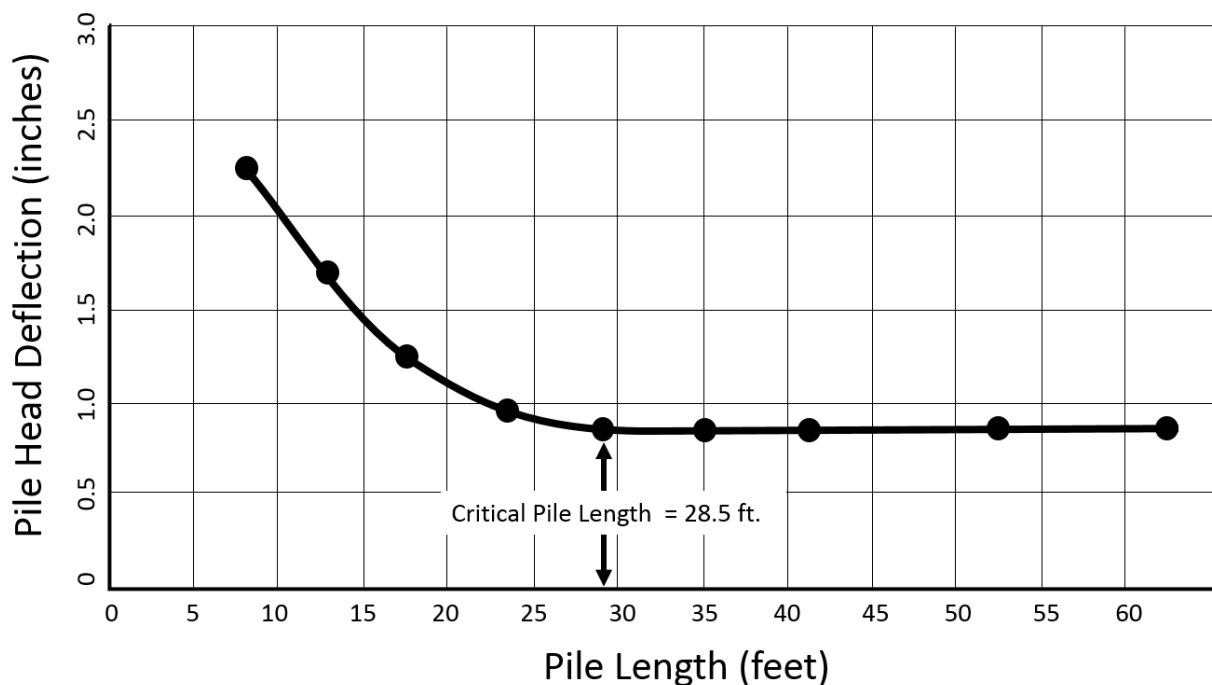

Figure 6.13.2.4.2.1-3 Example Summary of P-y Method Analysis Pile Length Verses Pile Head Deflection to Determine the Critical Pile Length

In cases where a pile is driven to the top of rock, but does not have adequate embedment to develop fixity, the pile will need to be drilled and set in the rock. The depth of the rock socket needs to be determined following the procedure discussed above. For more information on setting piles in rock, see [Section 6.13.2.4.2.2](#).

The determination of the point of fixity for deflection (used to check the Service Limit State case), as well as the point of fixity for moment and the critical pile length (used to check the Strength

Limit State case) as discussed above is relatively easily calculated with limited iteration between the geotechnical and structural engineer. This is due to the fact that the loading applied to the substructure is independent of the stiffness of the foundation. This is not the case for the Extreme Event I Limit State (seismic) load case, where the relative stiffness and deflection of each substructure determines how the total amount of lateral load is distributed between each substructure foundation. The structural engineer uses the same depth to deflection fixity for their initial Extreme Event I Limit State (seismic) analyses that was used in the Service and Strength Limit State analyses to determine the initial substructure loading and preliminary pile size. These loads and pile size are provided to the geotechnical engineer to determine the depth of fixity for deflection and moment for a range for lateral loads both higher and lower than those provided by the structural engineer. These are provided to the structural engineer using graphs as illustrated in [Figures 6.13.2.4.2.1-4\(a\)](#) and [\(b\)](#) for each substructure. The structural engineer will use the point of fixity for deflection graph to iterate until the assumed point of fixity results in a shear which is equal to the shear at the assumed fixity depth shown in the graph. Once the final lateral load is determined, it can be used with the moment fixity graph to determine if the pile size assumed in the original analysis is adequate to carry combined bending and axial loads. If it is not adequate, then the entire process needs to be repeated using a new pile size.

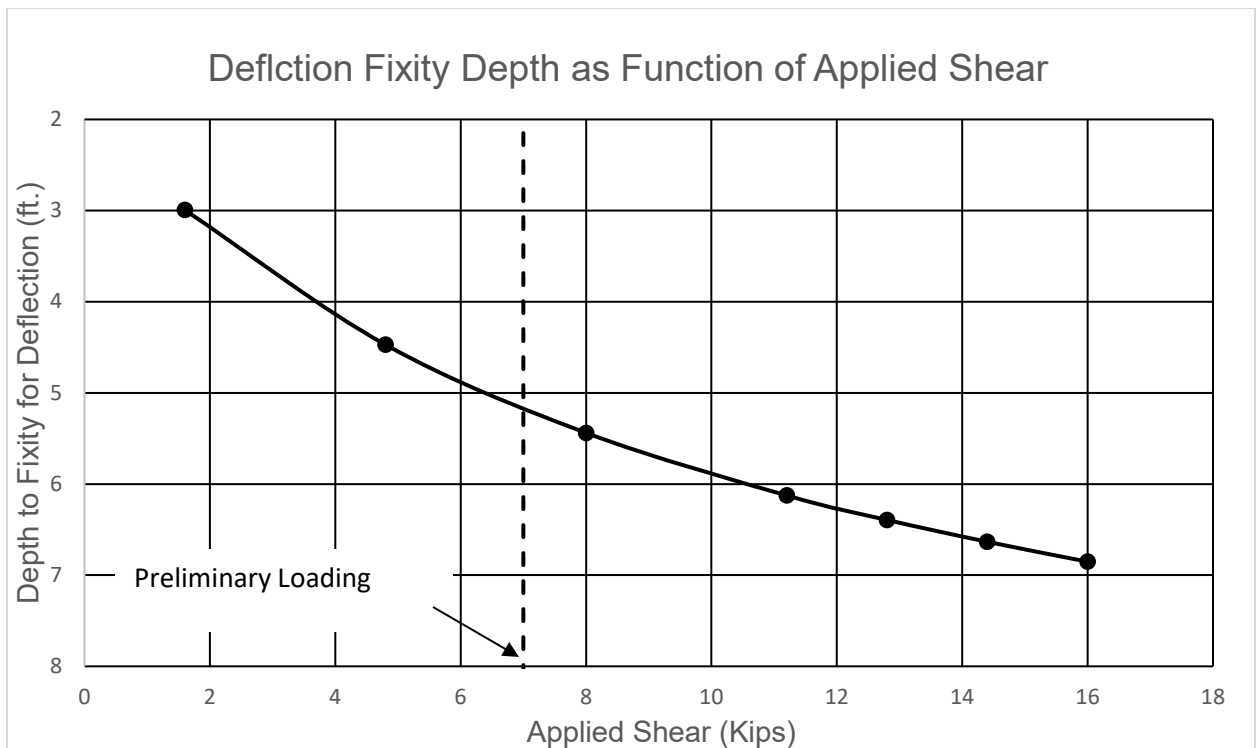

Figure 6.13.2.4.2.1-4(a) Example Relationship between Applied Shear and Depth to Fixity for Deflection

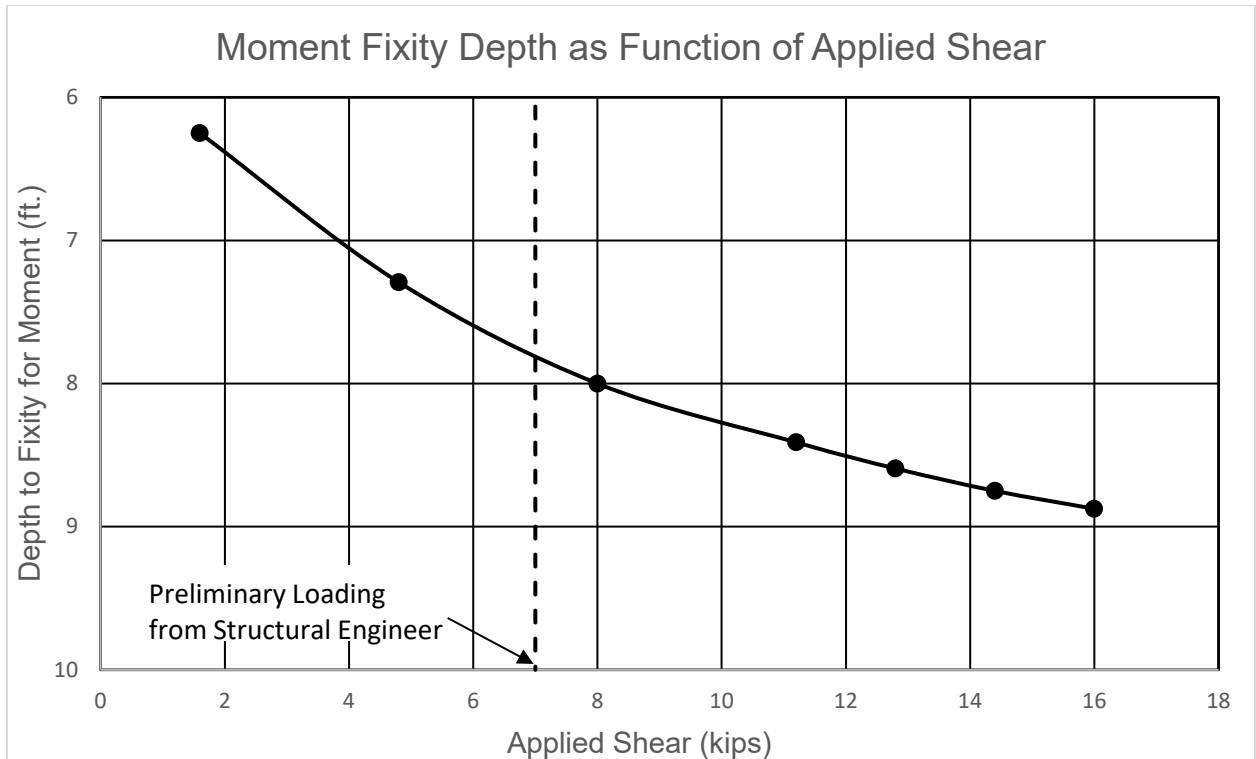

Figure 6.13.2.4.2.1-4(b) Example Relationship between Applied Shear and Depth to Fixity for Moment

6.13.2.4.2.2 Piles Set in Rock

There are a couple of cases when the lateral geotechnical capacity of a driven pile is inadequate to carry the lateral design loads of the structure. One case is when the depth to rock limits the ability of a driven pile to carry the required lateral loads. Another case is when the amount of predicted scour above bedrock would reduce a pile's ability to carry the required lateral load. For cases such as these, lateral capacity can be increased to carry the design loads by drilling and setting a pile into bedrock.

Factors affecting an end bearing pile's ability to carry lateral load include the amount of soil above bedrock, the strength of this soil, and the amount of load applied. As a general rule, when bedrock is within 10 to 15 ft. below the bottom of a substructure, soil-structure interaction analysis would need to be performed to determine if piles need to be set into rock. When the soil-structure interaction analysis indicates excessive pile head deflection (due to the combination of soil strength and bedrock proximity given the amount of lateral load demands), the pile would need to be set into rock to satisfy the deflection requirements.

The structural designer needs to specify on the plans the rock socket diameter and depth as well as the pile size. The socket diameter should be specified in 6-inch increments and be just large enough to allow a pile to be placed into the socket with sufficient room to permit placement of concrete such that it completely encases the pile. With the diameter established, the embedment in rock can be increased until the soil-structure interaction analysis indicates acceptable bearing stress on rock, pile stress and pile head deflection. With the necessary socket depth established to carry the lateral loads, the socket length needs to be checked to determine if it can carry the design axial loads. If necessary, the socket length can be increased to support the axial loads. Refer to [Section 6.13.2.3.5](#) for additional information on designing piles set into rock to resist axial loads.

Piles driven in soil profiles with bedrock depths substantially deeper than 10 to 15 ft. may also require the use of piles set in rock. In cases where the design scour depth(s) removes a considerable amount of soil above bedrock, a soil-structure interaction analysis should be conducted to determine if a rock socket is needed and its required depth, similar to the procedure above.

When setting piles into rock is specified on the plans, a special provision ([GBSP 56](#)) should be provided in the contract documents. Refer to [Section 8.10.8](#) for guidance on construction inspection and installation.

6.13.2.5 Integral Abutments

An integral abutment is classified as a type of open abutment, which is an abutment located at the top of an end slope. Bridges with integral abutments do not have joints at the abutment location but instead they are located at the end of the bridge approach pavement. Moving the joints beyond the abutment results in the bridge superstructure (deck and beams) exerting large lateral forces and deflection demands on the abutment foundations due to thermal expansion and contraction of the superstructure. To accommodate the deflection needs of the superstructure, only pile foundations may be used. These piles are limited to either metal shell or H-pile types, and they must be configured in a single non-battered row and oriented with their weak axis of bending placed at 90° to the centerline of the bridge. The piles must also extend 2 ft. into the abutment to create a fixed condition, which helps the pile withstand the lateral forces and resulting moment while at the same time carrying the axial loads.

The Department has developed a procedure for determining if an integral abutment is feasible and which pile types and sizes may be used. This procedure saves the geotechnical engineer and structural engineer from having to analyze each pile type and size for the proposed bridge length, bridge skew, and soil profile in order to determine which piles may be able to carry these combined loadings. This procedure is outlined in an on-line Design Guide titled “*Integral Abutment Pile Selection*”, and it has an accompanying Excel spreadsheet titled “*Integral Abutment Feasibility Analysis*” available to assist the geotechnical engineer in feasibility analysis and pile selection. (See [Section 6.19.](#))

When evaluating the feasibility for using integral abutments, there may be sites where the soils are too stiff to allow integral abutments. In these cases, the Department has successfully pre-cored the pile locations to 10’ below the abutment and back filled with bentonite pellets, which were hydrated and mixed in the hole to reduce the soil pressures on the pile during expansion. There may be other cases where the soil or rock conditions at an abutment(s) would appear to be better suited for other foundation types such as drilled shafts, a spread footing, or a pile type and/or size not permitted by this procedure. For such cases, the geotechnical engineer should note this fact in the SGR and offer an option to change the abutment type to a semi-integral abutment if it appears to be a more cost effective solution.

Refer to Section 3.8.3 of the [Bridge Manual](#) for addition discussion on integral abutments.

6.13.2.6 (Reserved)

6.13.3 Drilled Shaft Foundations

Drilled shaft applications are, normally, limited to soil profiles where rock formations are relatively shallow, and the drilled shafts can be founded in rock sockets. Drilled shafts are applicable when piles would result in insufficient embedment, and when the economics would preclude the use of a spread footing on rock. Drilled shafts can be advantageous for foundations in stream channel locations, to avoid the expensive construction of cofferdams. In such cases, the drilled shafts are developed above the ground line to become part of the substructure columns.

The FHWA publication number [FHWA-NHI-10-016](#) for “Drilled Shafts: Construction Procedures and LRFD Design Methods” by [Brown et al. \(2010\)](#) is available for reference in performing analyses of drilled shafts. [Sections 7.4.4](#), [7.4.5.5](#) and [7.4.6](#) for contain guidance on reporting design recommendations for drilled shafts, and [Section 8.11](#) provides an overview of construction inspection guidelines.

Refer to [Section 6.19](#) contains links to Design Guides for “*Axial Capacity of Drilled Shafts in Soft Shale*” and “*Axial Capacity of Drilled Shafts in Rock*” along with their corresponding spreadsheets.

6.13.3.1 – 6.13.3.4 (Reserved)

6.13.4 (Reserved)

6.13.5 Miscellaneous Structure Foundations

There are some other highway features which require foundations for support. Examples include traffic signal mast arms, high mast light towers, various sign structures, and noise abatement walls. Many of these types of structures have foundations that are considered to be lightly loaded in the vertical direction, relative to their lateral loading. In these cases, the geotechnical design of such foundations is often controlled by the lateral forces, overturning moments, or torsion caused by eccentric gravity loads and/or wind loads.

IDOT has standard base sheets which contain foundation design tables that are used in conjunction with a boring to determine the foundation depth and verify foundation soils adequacy. Only when the soil strengths are not adequate, site specific foundations should be designed.

6.13.5.1 Traffic Signal Mast Arms, High Mast Lighting Towers, and Sign Structures

Most traffic signal and lighting structures require single foundation elements. The usual foundations of choice are reinforced concrete drilled shafts, ranging from 24 in. to 60 in. in diameter. In very special circumstances; such as in soft soils, loose sands below the water table, and shallow rock; pile foundations, or spread footings are used. The foundations should be analyzed and designed to resist horizontal loads, moments, and torques.

Geotechnical engineers should evaluate boring data and applicability of standard foundation designs. If standard foundation designs are compatible with the soil conditions, then no additional

analyses or recommendations are necessary. To determine the standard foundation designs for a particular traffic structure, refer to the following:

- **Sign Structures:** For sign structures, contact the designer to determine the proposed type and size of sign structure. This information is used to determine the standard foundation depths. For [Cantilever](#), [Butterfly](#), [Tri-Cord](#), and [Single and Double Monotube](#) sign structures, the foundation shaft depths are shown on the base sheets. These base sheets are available on the IDOT web site and are contained in the [Sign Structures Manual](#). [Simple Span Overhead](#) sign structure foundation shaft depths are provided in Section 2.1 of the [Sign Structures Manual](#), and these depths are based on span length and sign area.
- **Traffic Signals with Mast Arms:** For traffic signal mast arm foundations, the standard shaft foundation depths are shown in the design table of [Highway Standard 878001](#).
- **High Mast Lighting Towers:** For high mast lighting towers, use the design table in [Highway Standard 837001](#). From the design table, the shaft length varies depending on the height of the tower and the average strength of the soil.
- **Luminaries (conventional light poles):** Although it is not the Department's standard practice to perform soil borings for luminaire (conventional light pole) foundations, standard design shaft depths and minimum soil strength parameters for luminaire foundations are provided in the [Highway Standard 836001](#). In the case of luminaries, the soil strength is evaluated during foundation construction. [Highway Standard 836001](#) shows standard details for both conventional drilled shafts as well as metal foundations consisting of a pipe with a helical screw or cutting teeth at its point.

Geotechnical engineers should evaluate boring data and applicability of standard foundation designs. When soil conditions are encountered that preclude the use of standard foundation designs, project specific foundation designs shall be performed in accordance with Article 13.6 of the [AASHTO "Standard Specifications for Structural Supports for Highway Signs, Luminaires, and Traffic Signals"](#) except the required drilled shaft depth shall be analyzed using Brom's Method per the procedure outlined in the "*Brom's Overturning & Torsion Capacity of Short Single Shaft*" ([Section 6.19](#)). Design loads for the foundation should be obtained from the BBS, and the Design Guide's companion Excel spreadsheet titled "*Brom's Overturning & Torsional Shaft Analysis*" can be access on the Department's website ([Section 6.19](#)).

Projects involving non-standard supports for traffic signals, luminaires, and sign structures will also require project specific foundation designs. The structural engineer for the non-standard supports should be contacted for the applicable foundation design loads.

6.13.5.2 Noise Abatement Walls

Support posts for ground mounted noise abatement walls typically utilize drilled shaft foundations. Per Section 3.12 of the [Bridge Manual](#), support post spacings and subsequent foundation designs should be in accordance with Section 15 of the “AASHTO LRFD Bridge Design Specifications” ([AASHTO, 2020](#)). Generally, these are required to be determined by a contractor as part of the noise wall design and shop drawing submittal that utilizes actual wall heights and post spacings not known during the design phase. However, the geotechnical engineer should evaluate the borings and provide the appropriate foundation design parameters (unit weight of soil, soil internal friction angle, and soil cohesion intercept) at various regions of a noise wall in a Geotechnical Report or memorandum for inclusion on the plans and for use by a contractor.

6.14 Construction Details

Design recommendations should be feasible from a construction standpoint. Therefore, constructability must always be considered when making recommendations, and construction details are part of design recommendations.

There are few new alignments being constructed by IDOT. Most IDOT projects consist of improving existing roadways, structures, and facilities. Therefore, construction staging is a major design concern in these existing projects. Removal and replacement operations must be evaluated for stability of side slopes adjacent to existing facilities, especially pavements in use. Sheet piling is often used to stabilize cut slopes. However, sheet piling is a very expensive alternative, especially if cantilever sheet piling is not sufficient, and struts or anchors are needed. Removal and replacement may not be an economical solution, due to the high cost of sheet piling. Use of dry lime for subgrade treatment is not recommended in highly populated areas, or adjacent to highly trafficked areas, due to public concern with lime dust.

Construction details are particularly important for structures. Recommendations for temporary support must be provided, which includes sheet piling and cofferdams. Drainage needs for dewatering, and seal coats must be recommended to the designer.

Different parts of the State have typical construction methods; which are based on economics, effectiveness, and the availability of materials. The DGEs and their assistants should be contacted for local practice.

6.15 Special Problems

Special problems may require careful evaluation regarding their effect on the final improvement. One of the most common is active or abandoned mines. The presence of mines is reflected in local sinks or settlements of the ground surface. Equally important, though less frequent in Illinois, is the occurrence of karst topography. Karst topography consists of solution cavities and caverns in underlying limestone, which may also result in local sinks or settlements. Such situations should always be brought to the designer's attention during the planning phase (Phase I). At this phase, the design could be modified to correct the problem, or to provide for easier correction of future problems.

The geotechnical engineer may not be able to present design solutions to every special problem in the Geotechnical Report. The Report, however, may be the only place where such geological hazards are brought to the attention of the designer.

6.16 Contract Documents

When developing design recommendations, the geotechnical engineer is expected to be familiar with the basic components of the Department's construction contracts. Contract documents consist of:

- Plans with Notes
- Contract Special Provisions
- [Supplemental Specifications & Recurring Special Provisions](#)
- [Standard Specifications](#)

The geotechnical engineer should also be aware of the hierarchical relationships between these documents as described in Article 105.05 of the [Standard Specifications](#).

6.16.1 Standard Specifications and Special Provisions

The design recommendations shall be compatible with the [Standard Specifications](#), the [Supplemental Specifications and Recurring Special Provisions](#), and the various District Special Provisions. Standard procedures and materials are preferable, unless special needs justify special construction techniques, or materials. The design recommendations should include a

recommended special provision for all project specific construction techniques, or materials. Refer to [Section 6.16.2](#) for guidance on developing special provisions.

Special provisions are defined in Article 101.42 of the [Standard Specifications](#) as additions and revisions to the Standard and Supplemental Specifications covering conditions peculiar to an individual contract. The need for a special provision is identified and, if necessary, developed for incorporation to the contract bid documents during the Phase II design stage. These are known as Contract Special Provisions. Contract Special Provisions include:

- [BDE Special Provisions](#)
- [Guide Bridge Special Provisions \(GBSP\)](#),
- Central Bureau of Materials (CBM) Special Provisions
- District Special Provisions
- Project Specific Special Provisions

Many of these Contract Special Provisions are readily available as District specials and statewide specials such as the [BDE](#), [GBSP](#), and the CBM special provisions. Refer to Section 66-1 of the [BDE Manual](#) for additional information on specifications and special provisions.

6.16.2 Project Specific Special Provisions

Project Specific Special Provisions are typically written to address a unique situation or a new product or technique. Examples of geotechnical engineering related Project Specific Special Provisions may include special instrumentation for construction monitoring, special material requirements, specialized ground improvement, etc.

Ultimately, designers are responsible for the development and compilation of Contract Special Provisions. However, some topics require technical expertise in the subject matter. As such, geotechnical engineering related Project Specific Special Provisions require development and/or review by the DGE, CBM's CSU and/or BBS's FGU.

When preparing a special provision, the following criteria shall apply in addition to that given in Section 66-1.04 of the [BDE Manual](#):

- Construction and material inspection, testing, and acceptance (according to IDOT practice and testing capability) shall be addressed in the special provision. Construction materials

used on a project must undergo an inspection process to ensure that the quality of the material and construction meet contract specifications. This inspection process includes procedures for Evidence of Inspection and Method of Acceptance of materials and construction work as discussed in the [PPG](#).

Materials covered by the [Standard Specifications](#) have sampling and testing criteria listed in the [PPG](#). However, sampling and testing of some materials included in a Project Specific Special Provision may not be covered by the [PPG](#). In such instances, the Evidence of Inspection and Method of Acceptance criteria should be included in the special provision for any materials and construction work not listed in the [PPG](#). This includes addressing the minimum frequency of sampling and testing requirements for the materials and construction work. When developing these Project Specific Special Provision requirements, the specifications for Evidence of Materials inspection and Method of Acceptance should utilize the criteria categories presented in Attachments 3 and 4 and the sampling schedules of the [PPG](#) as appropriate for the situation.

- Test methods specified in a special provision should give precedence to Illinois Test Procedures and Illinois Modified test procedures over standard AASHTO and ASTM test procedures. Additionally, if there are equivalent test methods for AASHTO and ASTM, the AASHTO test method shall be specified.

6.17 Drainage System Filter Requirements

For drainage system filter design, it is important to use a combination of materials such that both head loss and movement of fines are avoided. Materials used for filter media are typically granular materials and geosynthetics. When using these materials, the optimal or ideal particle size distribution of a granular filter material and the required properties of a geosynthetic material is dependent upon the soils being protected.

Filtration systems are used for several drainage applications mentioned throughout this Manual. [Sections 6.3.4.2](#) and [6.3.4.3](#) discuss pavement drainage systems, [Section 6.4.4.3](#) uses drainage systems to aid consolidation with vertical drains and drainage blankets, and [Section 6.5.2.2](#) covers backslope drains for slope stability. The filter system used for any of these drainage applications should meet the following criteria:

- a) To avoid head loss in the filter: $(D_{15} \text{ filter} \div D_{15} \text{ protected layer}) > 4$, and the permeability of the filter must be adequate for the drainage system.

Where:

$D_{15} \text{ filter}$ = diameter through which 15% of the filter material will pass by weight

$D_{15} \text{ protected layer}$ = diameter through which 15% of the protected layer material will pass by weight

- b) To avoid movement of particles from the protected layer:

$(D_{15} \text{ filter} \div D_{85} \text{ protected layer}) < 5$,

$(D_{50} \text{ filter} \div D_{50} \text{ protected layer}) < 25$, and

$(D_{15} \text{ filter} \div D_{15} \text{ protected layer}) < 20$.

For a very uniform protected layer ($C_u < 1.5$):

$(D_{15} \text{ filter} \div D_{85} \text{ protected layer})$ may be increased to 6.

For a broadly graded protected layer ($C_u > 4$):

$(D_{15} \text{ filter} \div D_{15} \text{ protected layer})$ may be increased to 40.

NOTE: $C_u = (D_{60} \div D_{10})$ = coefficient of uniformity.

- c) To avoid movement of the filter into the drain pipe perforation or joints:

$(D_{85} \text{ filter} \div \text{slot width}) > (1.2 \text{ to } 1.4)$.

$(D_{85} \text{ filter} \div \text{hole diameter}) > (1.0 \text{ to } 1.2)$.

- d) To avoid segregation, the filter should contain no particle size larger than 3".

- e) To avoid internal movement of fines, the filter should have no more than 5% passing No. 200 (0.075 mm) sieve.

When the above criteria cannot be satisfied without using a multfilter media, the use of a suitable geosynthetic fabric can be included with a granular material. In this application, the fabric may be used to wrap the pipe in order to satisfy the opening requirements, or to line the trench so that

it is protected from the movement of fines into the collector. The criteria for acceptance of geotextiles, for their many possible applications, are discussed in the publication [FHWA-HI-95-038](#), “Geosynthetic Design and Construction Guidelines” by [Holtz et al. \(1998\)](#). This publication is recommended both as a reference and for a listing of the properties desirable for acceptability, in a given application. Fabrics or drainage materials specified in the [Standard Specifications](#) should be used, if possible. If another fabric is required to be used, a project specific special provision addressing material properties, storage, handling, and installation shall be included in the plans.

6.18 Geosynthetics – An Overview

The term “geosynthetics” refers to all fabricated synthetic (usually polymeric) materials used in various geotechnical applications; such as drainage, reinforcement, erosion control, and light weight fill applications.

The development of geosynthetics offers a range of new products for providing: 1) tensile characteristics to soils; 2) separation of different particle size materials; 3) filtration to allow movement of water without movement of soil fines; 4) a retaining system; and 5) serving more than a single purpose by employing the products in combination, if necessary. In most cases, geosynthetics (geotextiles or geogrid) are used to provide these benefits. However, metal reinforcement has been extensively used in MSE walls.

The use of geosynthetics may expedite construction, enhance stability, and realize economic advantages that do not occur with soil-aggregate systems.

6.18.1 Geosynthetic Types and Applications

Each geosynthetic type fits a certain application. The following is an alphabetical list of the different geosynthetic types, which have been used on highway geotechnical projects. Information about and specification ranges for the various geosynthetic types were obtained from the annual “[Geosynthetics Specifier’s Guide](#)” published by Industrial Fabrics Association International (IFAI) of Roseville, Minnesota.

6.18.1.1 Geocells

Geocells are designed to: protect slopes against erosion, stabilize steep slopes, provide protective linings for channels, support heavy construction traffic on weak subgrade soils, and provide multi-layered earth-retaining structures. Geocells are typically made from high-density polyethylene (HDPE). The cells in the three-dimensional panels are opened and filled with granular materials. The granular material adds weight to make the multi-layer system act as a gravity retaining wall, and it provides free drainage. Typical geocell wall thicknesses vary from 50 to 70 mil (1 mil = 0.001 in.). The mass density per unit area of geocell varies from 12 to 97 oz./yd.². The expanded cell dimensions, area/depth/length, vary from 0.1 to 1.1 ft² / 2 to 8 in. / 8 to 16 in.

6.18.1.2 Geocomposites

Geocomposites are designed to replace aggregate and/or perforated pipe subsurface drainage systems. A geocomposite consists of a deformed, perforated or slotted, plastic core and a geotextile (filter) fabric wrap. Geocomposites include geonets, pavement edge drains (drainage mats), and sheet (wall) drains. Wick (strip) drains for expediting drainage of deep, compressible soil deposits; have also been included in the geocomposite category. The core material could be HDPE, polypropylene (PP), polyvinyl chloride (PVC), high impact polystyrene, or a combination of two polymers. For wick drains, the typical width/length/thickness core dimensions are 0.3 ft. / variable / 120 mils. For drainage mats and wall drains, the core dimensions, width/length/thickness, vary from 0.5 to 4 ft. / 10 to 100 ft. / 250 to 1,600 mils. The compressive strength of drainage mats and walls (ASTM D 1621) varies from 1 to 145 psi. At a gradient of 0.1 and a pressure of 5.5 psi, the in plane flow rate (ASTM D 4716) varies from 4.4 to 45 gal./min./ft.

6.18.1.3 Geofoam

Geofoam refers to low-density cellular plastic foam, either molded expanded polystyrene (EPS) blocks or extruded polystyrene (XPS) sheets. Geofoam is used as a super light-weight fill, with 1.5 to 4 pcf mass density, compared to other light-weight materials with 50 to 70 pcf. The geofoam's light-weight makes it a viable option for landslide repair and for embankments on soft, compressible deposits. Geofoam is also used for thermal insulation of pavement and foundations. Geofoam, however, requires special design to consider buoyancy, fungus attack, and the presence of petroleum products (asphalt, oil, or gasoline).

6.18.1.4 Geogrids

Geogrids are used for soil reinforcements in embankments and walls, subgrade stabilization and/or separation, and embankment base reinforcement. Geogrids are characterized by integrally connected elements, with in-plane apertures (openings) uniformly distributed between the elements. The apertures allow the soil to fill the space between the elements, thereby increasing soil interaction with the geogrid and ensuring unrestricted vertical drainage. The geogrids vary in manufacturing process, polymer type, coating, density, aperture dimensions, and tensile strength. Depending on the brand name and material, the geogrid could be woven, non-woven, knitted, laminated, or extruded. The geogrid could be made of polyester, polypropylene, polyethylene or fiberglass. The material coating, if needed, could be PVC, polyester, bitumen, elastomeric polymer, or latex. The mass density per unit area of geogrids varies from 4 to 40 oz./yd.². Aperture size varies from 0.2 to 4 in. The wide width ultimate tensile strength (ASTM D 4595) varies from 1,200 to 26,000 lb./ft. The tensile strain varies from 8 to 20 %.

6.18.1.5 Geomembranes and Geonets

Geomembranes serve as hydraulic barriers. Geonets are horizontal drainage mats, often used in conjunction with geomembranes in landfill applications. Geomembranes and geonets have very limited use for highway projects. However, transportation agencies have increasing environmental concerns. Therefore, geomembranes could be used for containment of spills, leaking underground storage tanks (LUST) or other hazardous materials within the R.O.W.

6.18.1.6 Geotextiles

Generally, geotextiles provide separation, reinforcement, filtration, drainage, and hydraulic barrier. A geotextile may be woven, non-woven, or knitted. Woven fabrics exhibit high tensile strength, high modulus, and low strain. Non-woven fabrics typically have high permeability and high strain characteristics. Geotextiles are available in a variety of geometric and polymeric composition, to serve various applications. Most geotextiles are made of polypropylene.

The long-term performance of a geotextile is a function of the durability and creep characteristics of the polymer structure. In a permanent installation, it is important that the polymeric material is resistant to the effects of ground, weather, and aging conditions. The mass per unit area of geotextiles varies from 1.8 to 42 oz./yd.². The grab tensile strength (ASTM D 4632) varies from 50 to 500 lb. The elongation (strain) varies from 7 to 70 %.

6.18.2 Usage by IDOT

The uses and types of geosynthetics are expanding rapidly. IDOT uses some of the geosynthetic types, mentioned above, in various applications. The [Standard Specifications](#) address several materials including: Fabric Envelope for Pipe Underdrains; Geotextile Fabric for Ground Stabilization, and Silt Filter Fence; Filter Fabric for Use with Riprap; Fabric for Fabric Formed Concrete Revetment Mats; Geotechnical Fabric for French Drains; Geosynthetic Soil Reinforcement for Retaining Walls; Erosion Control Blankets; and Geocomposite Wall Drain.

If a geosynthetic material is recommended, and it is not referenced by the [Standard Specifications](#), a Special Provision must be developed to specify material properties, transportation, storage, construction installation method, and any short- or long-term protection. In addition to the IFAI's "[Geosynthetics Specifier's Guide](#)", mentioned in [Section 6.18.1](#), [Holtz et al. \(1998\)](#) also provides a useful guide for preparing specifications for geosynthetic materials.

The CBM has limited testing capabilities for geosynthetic materials. Therefore, acceptance of geosynthetic materials is primarily based on a manufacturer's certification. The tensile strength test is conducted by the CBM. Some geosynthetics have not been approved for a variety of reasons, including concerns with the long-term strength (creep) and durability. There are a number of commercially available products, for which the engineering analysis is based on the manufacturer's recommended method. Such methods should be carefully evaluated by the geotechnical engineer. The CBM should be contacted for current practice, and review of District Special Provisions to ensure uniform statewide practice.

6.19 Design Guides & Spreadsheets

Table 6.15-1 lists Geotechnical Design Guides and Microsoft Excel spreadsheets (with Web Links) which are supplements to this Manual. An index of the Geotechnical Design Guides and corresponding spreadsheets can also be found on the Department’s website under the **Foundations & Geotechnical listings:**

- The website navigational path to this location is [Home > Doing Business > Procurements > Engineering, Architectural & Professional Services > Consultant Resources](#). On this page, select the “Bridges & Structures” tab located near the middle of the page, and then the information is listed under the “Foundations & Geotechnical” drop-down button located about half-way down the “Specific Scope of Services” list.

Design Guide	Spreadsheet	Description
Axial Geotechnical Resistance of Driven Piles (Section 6.13.2.3.1.1)	PILE CAPACITY AND LENGTH ESTIMATES	IDOT Static Method of Estimating Pile Length vs. Resistance
Existing Foundation Load Carrying Capacity (Section 6.13.2.2.1)	EXISTING PILE CAPACITY	Provides maximum pile capacity that can be assumed when checking to see if a substructure can be re-used.
	WSDOT PILE BEARING VERIFICATION (Section 8.10.6.1)	Provides Pile Inspectors Charts/Graphs to Determine the Nominal Driven Bearing Indicated by the WSDOT Dynamic Formula
LRFD Soil Site Class Definition (Section 6.12.2.1.1)	SEISMIC SITE CLASS	Provides a Bridges Seismic Site Class
Liquefaction Analysis (Section 6.12.3)	LIQUEFACTION	Calculates the Factor of Safety Against Liquefaction
Cohesive Soil Settlement Estimate (Section 6.9.1.1)	Cohesive Soil Settlement Estimate	Estimates Primary Settlement of Cohesive Layers using Moisture Content and Q_u
Cofferdam Seal Coat Design	COFFERDAM SEAL COAT DESIGN	Determines a Cofferdams Factor of Safety Against Hydrostatic Uplift

Table 6.19-1 Geotechnical Design Guides & Spreadsheets Summary

Design Guide	Spreadsheet	Description
Axial Capacity of Drilled Shafts in Soft Shale (Section 6.13.3)	DRILLED SHAFT AXIAL CAPACITY - SHALE	Provides Drilled Shaft Factored Resistances in Soft Shale <100ksf for various diameters and depths as well as the top of shaft deformation under service loading.
Axial Capacity of Drilled Shafts in Rock (Section 6.13.3)	DRILLED SHAFT AXIAL CAPACITY IN ROCK	Provides Drilled Shaft Factored Resistances in hard rock for various diameters and depths as well as the top of shaft deformation under loading.
Brom's Overturning & Torsion Capacity of Short Single Shaft (Section 6.13.5.1)	BROM'S OVERTURNING & TORSIONAL SHAFT ANALYSIS	Provides the Shaft Foundation Depth Necessary to Resist the Overturning and Torsional Load from Traffic Signals, Sign Structures and Light Poles/Towers
Temporary Geotextile Wall Design (Section 6.8.2.4)	Temporary Geotextile Wall Analysis	Analyzes the Pullout Resistance and Stress in Geotextile Walls
Temporary Sheet Piling Design Charts (Section 6.8.2.4)	Temporary Sheet Pile Design Analysis	Provides a Simple but Conservative Procedure to Provide a Temporary Sheet Pile Design
Permanent Sheet Pile Design Policy (ABD Memo 11.4) (Section 6.8.2.4)	SSP Dimensions All-IDOT (8)	Provides Sheet Pile Properties to determine $(b/t_{min})^{\epsilon}$ used to determine if local buckling will control the sheeting section modulus design.
Integral Abutment Pile Selection (Section 6.13.2.5)	INTEGRAL ABUTMENT FEASIBILITY ANALYSIS	Determines the Feasibility of using an Integral Abutment Given Bridge Length, Skew and Soil Borings

Table 6.19-1 Geotechnical Design Guides & Spreadsheets Summary (Continued)

This page left intentionally blank.

Chapter 7 Geotechnical Reports

7.1 Introduction

Geotechnical Reports are used to convey subsurface exploration data, laboratory test results, geotechnical analyses, design data and recommendations, and construction specification recommendations. The Department uses three main types of reports to convey information to the various end users. These reports are:

- Corridor and Preliminary Feasibility Geotechnical Reports ([Section 7.2](#))
- Roadway Geotechnical Report ([Section 7.3](#))
- Structure Geotechnical Report ([Section 7.4](#))

Corridor and Preliminary Feasibility Geotechnical Reports are developed for new alignments as part of a Phase I study. Roadway and Structure Geotechnical Reports focus on Phase I/II design and final plan preparation efforts for roadways and structures. Roadway and Structure Geotechnical Reports are primarily intended for use in Phase II design to provide the designer with recommendations that are specific to the selected alignment, to provide safe transportation and long road life at a reasonable cost. However, they are also often used by field inspection personnel, and may be made available to contractors. In general, these reports should be as brief as possible and yet thorough enough to comprehensively provide information needed for project design and construction. This chapter outlines the general content and format for each report type. However, the content of each report shall be tailored to address the scope of an individual project.

When reports are required for some types of Special Investigations projects, they typically have content and formats that are tailored specifically for the project as directed by the DGE. However, in the case of Pavement Rubblization Geotechnical Reports, there are specific report content and format requirement which are outlined in [Section 7.5](#).

7.2 Corridor and Preliminary Feasibility Geotechnical Reports

In the designer's evaluation process, Phase I Corridor and Feasibility Studies typically include consideration of geologic conditions and their potential engineering effects and economies for the various alignments. A Corridor Geotechnical Report or Preliminary Feasibility Geotechnical Report provides information to assist in this evaluation process.

7.2.1 Corridor Geotechnical Reports

Corridor Studies during the planning phase (Phase I) of a major highway facility often evaluate more than one corridor and possibly several alignments within a corridor. The purpose of Corridor Geotechnical Reports is to provide a generalized insight into areal geology, pedology and other engineering factors that may have an impact on the cost of alignment selection. When preparing the feasibility report, information from reconnaissance aerial photography; State geological, agricultural, and water surveys are reviewed; and at least one field exploration program is conducted.

For reconnaissance, engineering and geological reports prepared by and for IDOT are excellent sources of information. Engineering and geological reports may provide general subgrade information, foundation conditions, cut and fill locations, stability of cut slopes and embankments, and settlement problems within the project limits. Regional, bedrock, and surficial geology should also be discussed in the feasibility report and could be available in existing geological reports. County agricultural reports and maps should also be reviewed. Agricultural reports contain maps showing the location and extent of the various soil types that occur in that county. See [Section 3.2](#) for additional information regarding reconnaissance of aerial photography, agricultural reports, and geologic maps.

At least one field exploration program should be conducted along each corridor or alignment. Depending on the complexity of the project and the amount of available information, the exploration program may consist of a cursory survey by walking or driving through the project, or as detailed as conducting a subsurface exploration. During the exploration, features that have the potential to pose a problem should be identified and discussed in the Report. Slope cuts, quarries, gravel pits, strip mines, springs, and caverns are examples of features that should be identified, and their engineering implications discussed in the feasibility report.

The Corridor Geotechnical Report should consider the engineering implications of all available information and data. It is important, to identify potential problems and possible remedial measures, including those that may be encountered during construction.

Corridor Geotechnical Reports shall include:

- Cover Sheet and Table of Contents
- Introduction, Project Description, and Scope
- A generalized summary of the reconnaissance of available information ([Chapter 3](#)) from review of literature and other existing documents regarding pertinent geologic, pedologic, and geotechnical engineering data for the corridor options being considered. Cite the sources of the information provided in the Report (USDA county soil survey reports, etc.).
- Discussion on the potential engineering effects of the available information and data. This includes noting potential problems as well as possible remedial measures.
- Aerial maps which show the project corridors/alignments, surficial pedology and locations of geological and man-made features which have geotechnical engineering considerations.
- Summary of exploration, testing procedures, and field conditions (if applicable).
- Borings, boring location map(s), and laboratory test results (if obtained or historic).
- Other applicable supporting documentation as required by the project scope

Section 11-2.10 of the [BDE Manual](#) can also be referenced for additional discussion on geotechnical considerations for a Corridor Geotechnical Report.

7.2.2 Preliminary Feasibility Geotechnical Reports

Section 12-1.02 of the [BDE Manual](#) describes a Feasibility Study as a Phase I study, which is similar in scope and purpose to a Corridor Study. However, the scope may focus on either a corridor or a localized improvement. Feasibility Studies are typically prepared to assess whether or not a proposed highway improvement warrants further study or additional funding for Phase I engineering costs. Preliminary Feasibility Geotechnical Reports shall follow with a format and content of the Corridor Geotechnical Reports and adapted as appropriate for the scope of the Feasibility Study.

7.3 Roadway Geotechnical Report

The Roadway Geotechnical Report is used in the design phase (Phase II) by the designer to develop design plans for a specific improvement or a selected alignment. The Report should meet the minimum requirements specified in the following sub-sections.

7.3.1 RGR Study Determination and Reporting Criteria

Design phase roadway geotechnical studies are to be conducted and RGRs prepared for all projects involving new construction, widening in excess of 6 ft., grade changes, or relocations. Exceptions include the following:

- 1) For projects with less than 3,000 yd² of new pavement and no unusual conditions, the DGE may elect to waive the Roadway Geotechnical Design Study or to prepare an Abbreviated RGR or Geotechnical Design Memorandum.
- 2) For projects less than one mile in length and involving less than one full-lane (12 ft.) of widening, constructed on the existing roadbed, the DGE may elect to prepare an Abbreviated RGR, rather than a formal, Roadway Geotechnical Report.

Note: At a minimum, the abbreviated reports shall contain a description of the project, a location map, a summary of the geotechnical exploration, and recommended treatments.

For projects other than those discussed in items 1) and 2), a Roadway Geotechnical Report is required, and approval by the DGE should be obtained, prior to implementing the final recommendations on the plans. Projects that involve unusual soil conditions, high fills or deep cuts (greater than or equal to 15 ft.) will also require either a Roadway Geotechnical Report, Abbreviated RGR, or Geotechnical Design Memorandum, and review and approval by the DGE, regardless of the project size or amount of new pavement.

Review and approval of all RGRs, Abbreviated RGRs, and Geotechnical Design Memorandums by the DGE is required. Copies of these reports and memorandums are to be retained by the DGE in the District files in accordance with Departmental records retention policies. (Refer to [Section 7.3.2](#) for the RGR submittal and review process.)

7.3.2 Submittal and Review Process

Development and review of RGRs is under the purview of the DGE. For projects with complex issues, the DGE can request assistance and review from the Central Office Geotechnical Engineer. For consultant prepared projects, an RGR goes through a submittal and review processes as directed by the DGE. Electronic submittal requirements of RGRs shall also be as directed by the DGE.

Consultant prepared RGR's shall be signed and sealed by an Illinois Licensed Professional Engineer.

7.3.3 RGR Format and Content

For uniformity in report format, RGRs shall be prepared with the following outline:

- Cover Sheet and Table of Contents
- Project Description, Location and Scope
- Geology and Pedology
- Field Exploration
- General Subgrade Conditions
- Slope Stability Analysis and Results
- Settlement Analysis and Results
- Minor Structure Foundations
- Special Conditions
- Construction Monitoring
- Appendices (Supporting Documentation): location map, boring plan and soil profile, boring logs, laboratory test results, SSR Charts, photographs, settlement and slope stability calculations, etc.

This outline shall be divided up into additional sub-sections as necessary. Due to the fact that project size and scope-of-work can vary, it is anticipated that information requested in some sections may not apply to a given project or that additional information may need to be added.

7.3.3.1 Cover Sheet and Table of Contents

In addition to the Region and District of the project location, indicate the route, section, county, IDOT project and contract numbers, original and revised (when applicable) report dates, as well as the name, email address, and phone number of the RGR author. When the Report is prepared by a consultant, include the name, address, and phone number of the firm. Following the cover sheet, provide a table of contents indicating the subsequent sections and attachments.

7.3.3.2 Project Description, Location and Scope

As a minimum, this section should include the following items:

Provide a general description of the proposed improvement identifying major components of the project. This description should include the existing pavement condition, pavement width, number of traffic lanes, median, intersections, grade separations, and length of the improvement in feet or miles. A description of proposed pavement structures and types, if known, as well as the type of pavement that affects the soil recommendations should also be included.

Identify the project location, length, omissions/gaps, and include a reference to a location map discussed in [Section 7.3.3.11.1](#).

Discuss specific improvements that are discussed in the Report and highlight unusual aspects of the project. Provide a general overview of the scope of the geotechnical work for the project. The scope discussion should include references to any other Geotechnical Reports, such as Structure Geotechnical Reports, that fall within the project limits of the RGR study. Also, identify the version or date of any preliminary plans used to develop the RGR.

7.3.3.3 Geology and Pedology

The first step of any Roadway Geotechnical Report should be the examination of all pertinent available geologic and pedologic information. Applications of geological and pedological knowledge provide the groundwork for delineating types of earth materials, and potential problem zones. The Roadway Geotechnical Report should include a discussion of the geology and pedology along the proposed alignment, and the associated engineering impacts. See [Section 3.2.2.3](#) – Geology and Pedology, the Bibliography ([Appendix F](#)), and [Appendix A](#) for obtaining information on Illinois geology and pedology.

7.3.3.4 Field Exploration

The field exploration section of the Roadway Geotechnical Report should include a detailed discussion of the soils encountered and the field conditions during the exploration. The Report should indicate the date on which the field exploration was made, as well as information about any other explorations or investigations conducted. Climatic conditions during the exploration and for at least the 3 months prior to starting of the exploration should be summarized as discussed in [Section 7.3.3.4.1](#). This climatic information should be used to summarize the effects on groundwater fluctuations. A general description of the terrain should be included, with special emphasis on drainage and erosion patterns. Any conditions of high water and flooding, etc., which may have been noted during the exploration and might be of value in the design of bridges and culverts, should also be noted. Also, the Report should present a brief discussion of the type of drilling equipment, used during the exploration, and the hammer type, drilling method and casing depth, if any; all with reference to applicable AASHTO or ASTM standard methods/guidelines for conducting subsurface investigations.

General description of the soils encountered should consist of a summary of the soils and geologic conditions, which exist within the area of the proposed improvement. Reference to the boring plan and soil profile, which provides the graphical record of the subsurface explorations, should be included in this section. Guidelines for preparing the boring plan and soil profile sheets are provided in [Section 7.3.3.11](#).

Foundation boring logs, discussed in [Section 7.3.3.11.3](#), should also be included in the Report. All laboratory test results obtained from the field soil samples, except for the Q_u and moisture tests associated with stability borings, should be recorded on form [BMPR 508A](#), as shown on [Figure 7.3.3.5-1](#). The required data should consist of particle size analysis, Atterberg limits, the Illinois triangular diagram textural classification, and the AASHTO M 145 classification (including the group index). The bearing ratio for subgrade samples should be included.

7.3.3.4.1 Climatic Conditions Summary

When evaluating groundwater conditions, summarize the climatic precipitation during and for at least the 3 months prior to starting the exploration as shown in [Table 7.3.3.4.1-1](#). Compare the actual precipitation in the months during and preceding the exploration with the normal (historical average) amounts for those same months and discuss the fluctuation effects of the departure from normal precipitation on the observed groundwater conditions. Refer to [Section 3.2.2.4](#) for discussion on sources to obtain climatic precipitation data. Several sources for climactic data are available, and the data source shall be referenced in the RGR.

Month	Actual Precipitation (in.)	Normal Precipitation (in.)	Departure from Normal (+/- in.)
July	0.25	0.5	-0.25
August	1.00	1.50	-0.50
September	1.00	0.75	+0.25
October	1.50	2.00	-0.50
Total	3.75	4.75	-1.00

Table 7.3.3.4.1-1 Example Comparison of Actual and Historical Precipitation

7.3.3.5 General Subgrade Conditions

The Roadway Geotechnical Report should include a separate section describing any treatments necessary to provide a stable platform for the construction and paving machinery. All soil and subgrade recommendations must be specific to certain locations (stations), lengths, depths, and types of treatment that the designer can use to calculate plan quantities. This information is typically summarized in a table as shown in [Table 7.3.3.5-1](#). General, or vague, recommendations are not acceptable.

Location (length)	Estimated Thickness of Treatment	Treatment Width	Recommended Subgrade Treatment	Concerns
Sta. 106+00 to Sta. 109+00	12 inches	Entire North Widening Width	Remove and replace with Agg. Subgrade Improvement	Med. Stiff Black & Brown Clay, $Q_u=0.50$ to 0.74 tsf & $w=28\%$ (B-1)
Sta. 110+00 to Sta. 112+49	6 inches	Entire North Widening Width	Remove and replace with Agg. Subgrade Improvement	Med. Stiff Black & Brown Clay, $Q_u=0.75$ to 1.02 tsf & $w=35\%$ (B-2)

Table 7.3.3.5-1 Example Schedule of Subgrade Treatment Recommendations

The subgrade support values, plotted on the SSR chart for each individual soil type identified along the alignment, must be included on [Figure 7.3.3.5-2](#). Results of IBR values should also be discussed. Results of soil tests for each sample, collected during the soils exploration, should be documented on Form [BMPR 508A](#) as shown on [Figure 7.3.3.5-1](#).

Drainage conditions should be described according to one of the drainage classes discussed in [Section 6.3.4.1](#). Drainage information can also be obtained from the project specific County Soil Survey (published by USDA/NRCS). Locations of frost-susceptible materials, and remedial measures should also be addressed. A summary of this information and other subgrade test data is recorded on form [BMPR 507A](#), as shown on [Figure 7.3.3.5-3](#). Completion of this form will be determined by the DGE. This form should be inserted in an appendix of the Roadway Geotechnical Report. See [Section 6.3.3](#) for additional information on design recommendations for subgrade treatment.



**Illinois Department
of Transportation**

Soil Test Data

Route FAP 310 (US 67)

Section 69-2 (2B)

County Morgan

Location SW 1/4, SEC 10, TWP 15N, RNG 11W, 3 PM

Job No. D-96-549-00

Lab. No.		010143	010144	010145	010146
Station		743+00	743+00	743+00	743+00
Offset		55 ft Rt.	55 ft Rt.	55 ft Rt.	55 ft Rt.
Depth	ft	0-3.5	3.5-9	9-16	16-30
AASHTO Classification (AASHTO M 145)		A-7-6 (26)	A-6 (10)	A-6 (9)	A-6 (6)
Illinois Textural Classification		SiC	Silt	SiL	CL
Gradation Passing – 1"	%	100	100	100	100
3/4"	%	100	100	100	100
1/2"	%	100	100	100	100
No. 4	%	100	100	100	100
No. 10	%	100	100	100	100
No. 40	%	99.8	99.8	97.4	90.2
No. 100	%	99.2	99.7	93.4	71.6
No. 200	%	99.4	99.5	91.3	63.3
Sand (AASHTO T 88)	%	1	1	9	37
Silt (AASHTO T 88)	%	66	83	72	39
Clay (AASHTO T 88)	%	33	16	19	24
Liquid Limit (AASHTO T 89)	%	47.2	28.2	27.4	27.6
Plasticity Index (AASHTO T 90)	%	23.2	11.2	11.3	12.7
Organic Matter Content	%	-	-	-	-
Std. Dry Density (IL Mod AASHTO T 99)	pcf	106.5	-	114.4	119.9
Optimum Moisture (IL Mod AASHTO T 99)	%	18.9	-	14.4	13.3
Subgrade Support Rating		FAIR	POOR	POOR	POOR
In situ Moisture	%	-	-	-	-

Printed 11/14/2013 BMPR 508A (Rev. 08/23/13)
(Formerly BBS 2640)

Figure 7.3.3.5-1 Example Soil Test Data (Form BMPR 508A)

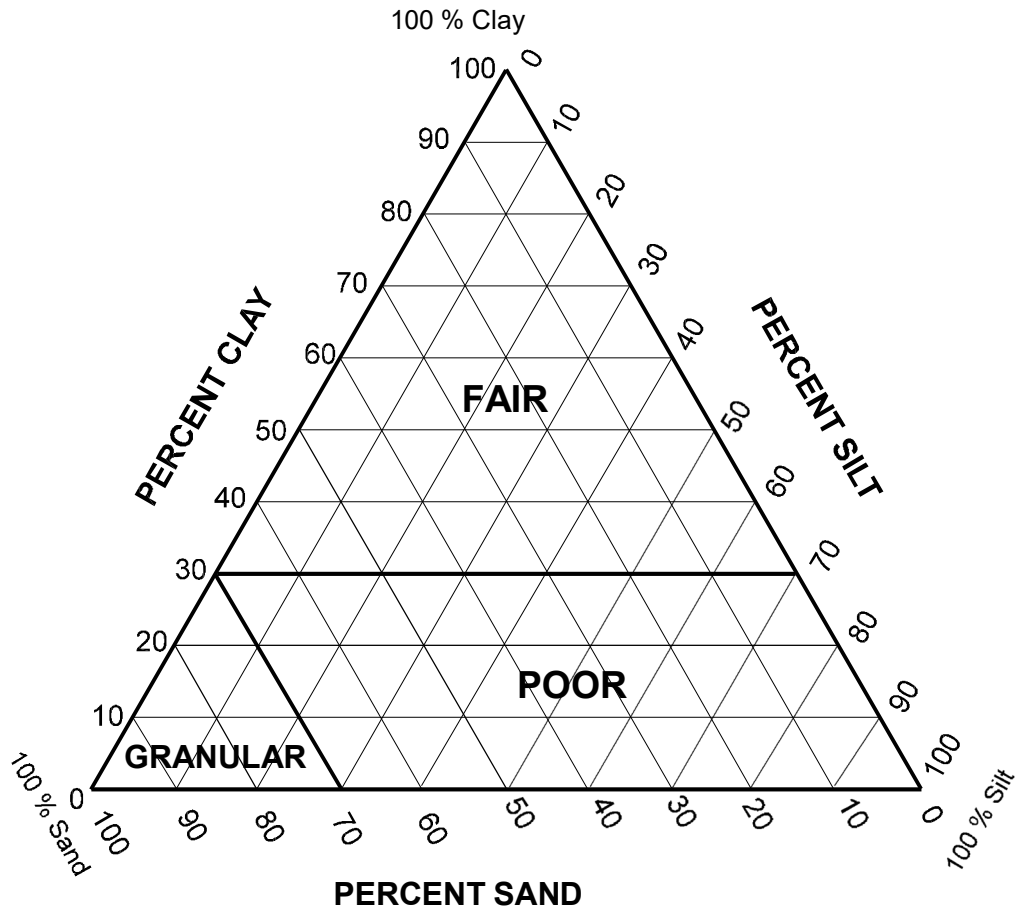



Figure 7.3.3.5-2 Subgrade Support Rating (SSR Chart)



**Illinois Department
of Transportation**

**Summary Report on Pavement,
Base and Subbase Design**

State Job Number: P-98-014-94 Project: US 67 Expressway Route: FAP 310

Section: 60-12 City or County: Madison Date: 6/1/95

ADT: 1000 Year: 1996 Design Period: 20 Year Class Highway: Major

Passenger Cars Per Day: 7000 Trucks S.U. Per Day: 700 Trucks M.U. Per Day: 600

Pavement Structure: _____

Type Surface Course: _____ Thickness: _____

Type Base Course: Bituminous Surface Course Thickness: 1.5 in.

Type Subbase Material: Lime Modified Soil Thickness: 12 in.

Sta. to Sta.	200+00 to 240+00	240+00 to 250+00	250+00 to 265+00	265+00 to 300+00
*Sta. of Test	Fill	235+00	245+00	285+00
*Drainage Class	Good	Fair	Fair	Fair
*Ave. Frost Penetration	24 in.	24 in.	24 in.	24 in.
Illinois Textural Classification		SiCl	SiCl	SiCl (Shaley)
Classification and Group Index (AASHTO M 145)		A-4(8)	A-6(10)	A-6(8)
*Percent Silt (AASHTO T 88)		63	57	61
*Illinois Bearing Ratio (%)	6.0	3.0	3.0	2.6
Std. Dry Density (IL Mod. AASHTO T 99)		106.1 pcf	107.0 pcf	113.5 pcf
Optimum Moisture (IL Mod AASHTO T 99)		16.5	17.3	14.5

* Indicates worst condition within the above station limits.

Remarks: _____

Printed 11/14/2013

BMPR 507A (Rev. 06/28/13)
(Formerly BBS 2630)

**Figure 7.3.3.5-3 Example Summary Report on Pavement, Base, and Subbase Design
(Form BMPR 507A)**

7.3.3.6 Slope Stability Analysis and Results

Results of the slope stability computations should be included in the Roadway Geotechnical Report, as well as a summary of the computations, indicating the parameters employed in making the computations. Testing methods and test data should be included in an appendix. Recommendations regarding the slopes, maximum depth of cut, or height of embankment should be clearly discussed in this section of the Report. See [Section 6.4.3](#) for minimum FOS and [Section 6.4.4](#) for remedial treatments of embankment stability. Also, see [Section 6.5.1](#) for minimum FOS and improvement of cut slope stability. As mentioned in [Section 6.10.2](#), all stability analyses should be based on the field Rimac Q_u , or the lab Q_u data from the Shelby tube samples. No stability analysis is to be made on the basis of the pp data.

7.3.3.7 Settlement Analysis and Results

Estimated settlement and the rate of consolidation should be included in the Roadway Geotechnical Report. A summary of the computations should also be included in the Report, indicating the parameters used in the computations. Data from laboratory consolidation tests should be included in an appendix. See [Section 6.9](#) and [Appendix D](#) for settlement analysis, and [Section 6.4.2](#) for remedial treatments of excessive settlements.

7.3.3.8 Minor Structure Foundation Recommendations

When applicable, Roadway Geotechnical Reports should include foundation construction recommendations for minor structures which do not have TSLs or fall under one of the SGR categories in [Table 7.4.1-1](#). Single box culverts covered in the [Culvert Manual](#), precast multiple barrel culverts (not on the interstate system), and retaining walls with less than 7 ft. exposed height are the most typical applications. Any treatment recommendations, such as removal of soft soils and replacement with select material, should be summarized in a table listing structure location and type, treatment limits (stations, offsets; and depth), treatment recommendation, and reason for treatment.

7.3.3.9 Special Conditions

As mentioned in [Section 6.15](#), special conditions such as presence of mines, local sinkholes, solution cavities, caverns, and seismic activities, should be mentioned in the Report. Erosion control issues discussed in [Section 6.6](#) should be addressed in the Report.

Locations and limits should be clearly described in the Report and illustrated on the boring plan and soil profile sheets. Specific recommendations concerning the problem locations, and provisions for contract plans should also be addressed, if necessary.

7.3.3.10 Construction Monitoring

Geotechnical instrumentation can be used to characterize initial site conditions, verify design assumptions, and/or monitor the effects of construction. Depending on the complexity of the project, instrumentation may vary from inclinometers, extensometers, piezometers, strain gages to even less sophisticated devices; such as, settlement platforms. Common parameters, monitored by the instrumentation, are pore water pressure, slope and foundation deformations, and loads on tiebacks or rock bolts. If monitoring is recommended, the Roadway Geotechnical Report should identify which parameter requires monitoring, the frequency of monitoring and locations (stations).

7.3.3.11 Appendices (Supporting Documentation)

The Report appendices shall contain all geotechnical data and supporting documentation. This includes location map, boring plan and soil profile, boring logs, laboratory test results, SSR Charts, photographs, etc. Additionally, this section shall contain only the critical computations necessary to support the major design recommendations, document design parameters, and analysis methods. Analyses such as settlement and stability are common examples of such calculations.

7.3.3.11.1 Location Map

A location map showing the location of the beginning and ending stations, and station equations, if applicable. Section, township, range, and city and county names (in urban areas) should also be included on the map. [Figure 7.3.3.11.1-1](#) shows a typical location map acceptable to IDOT. Listed below are the specifications for the location map.

- a) Scale of the map should be at 1 in. equal to 1 mile, indicating a north arrow. If there are many details required on the map, a larger scale may be used.
- b) Identification of the route number, section number, and the county.
- c) The proposed improvements properly located on the map, and station numbers plainly identified at the beginning and end of the project.
- d) Section lines, township, and range.
- e) Proposed pavement, or pavement together with location of interchanges, grade separation, and drainage structures.
- f) Station numbers or dimension needed to clarify the map.
- g) Railroads, wetlands, streams, or bodies of water that cross (or are adjacent to) the proposed improvements should be depicted.
- h) Streets and intersecting streets in urban areas.
- i) All cultural, environmental, and natural features should be labeled for proper identification.

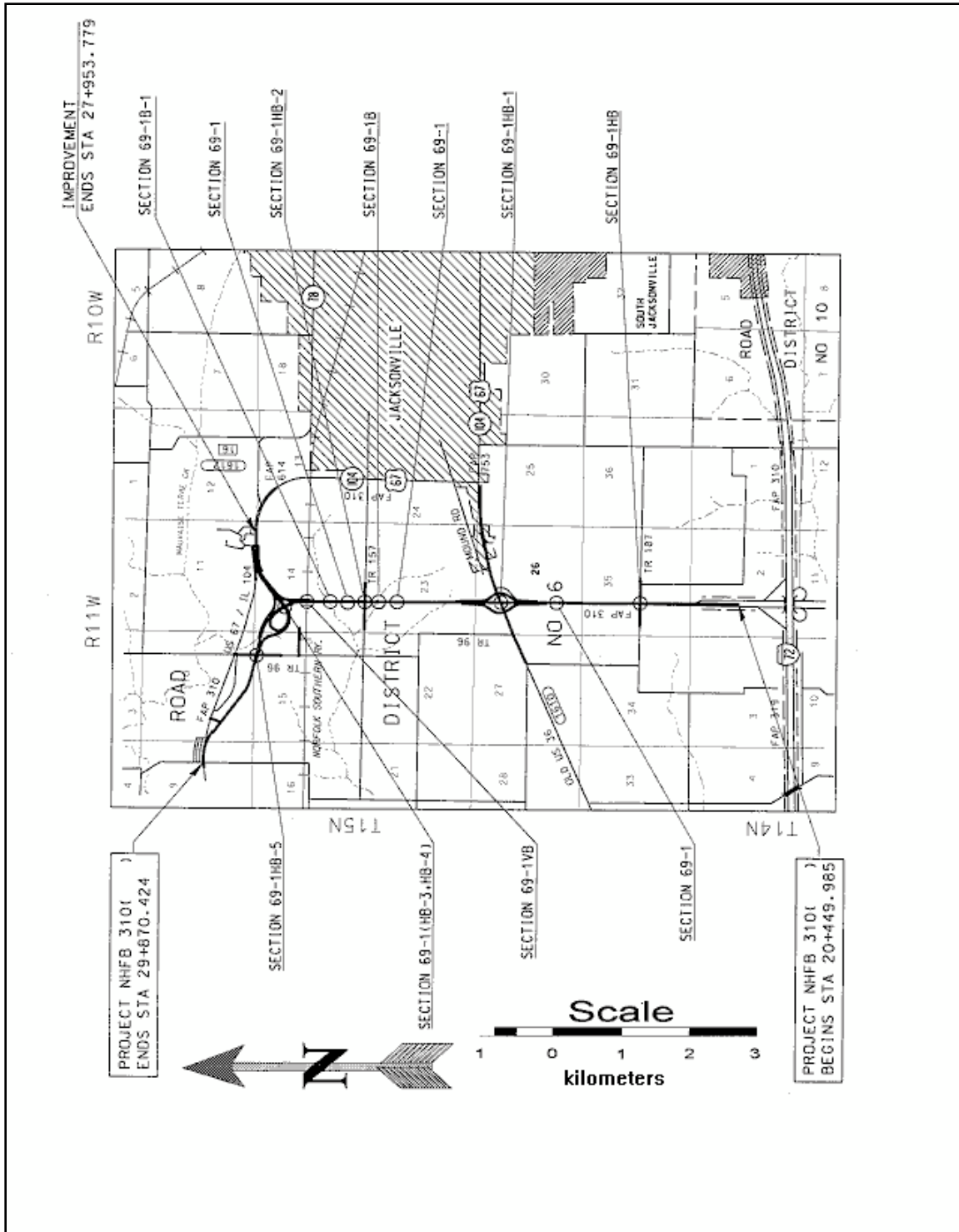

Figure 7.3.3.11.1-1 Example of Typical Location Map

7.3.3.11.2 Boring Plan and Soil Profile

A roadway plan, showing the areal distribution and location of soil borings along the proposed improvements, should be presented in a Roadway Geotechnical Report. A soil profile, showing a graphical record of the results of field exploration and subgrade conditions along the proposed improvements, should also accompany the boring plan. [Figures 7.3.3.11.2-1 \(a\), \(b\) and \(c\)](#) show typical boring plans and soil profiles acceptable to IDOT. Listed below are the specifications for the boring plan and soil profile sheets:

- a) The boring plan and/or the soil profile should have a legend on the first sheet, to identify all parameters or numerals used on the plan or the profile.
- b) A vertical scale of 1 in. equal to 5 ft., and a horizontal scale of 1 in. equal to 100 ft. should be used. Somewhat different scales may be used under special circumstances.
- c) Each profile sheet should be identified by route, section number, and county. Indicate the drawing scales and the stationing along the improvement.
- d) Profile of existing ground surface, and the PGL at the centerline of each pavement should be shown and designated. The PGL should be indicated by a line heavier than the ground surface line. Location of all borings, test pits, and other openings from which samples were taken and tested should be located, on both the roadway plan and the soil profile. The top of each soil profile and the thicknesses of the horizons encountered should be shown at the proper elevation. Each soil layer should be identified by its IDH textural classification, discussed in [Section 5.5.5.1](#), AASHTO M 145 classification and the group index; all to be included on the profile for each layer.
- e) The boundaries of all soil units should be shown on the plan, and properly designated by a series name or other symbolic notation, which should be explained in a legend.
- f) The position of all prominent natural or cultural features. Drainage ways, intersecting roads, and streets should be shown on the roadway plan.
- g) The elevation of any water encountered at completion of boring, and elapsed time from the opening of the borehole to the time of measurement should be shown (in parentheses) on the soil profile. (See [Section 4.6.1](#) for groundwater observation.)
- h) Indicate the groundwater depth and elevation 24 hours after completion of boring, when practical. If the observation is made at another time, give the number of hours that have elapsed.
- i) Indicate the elevation of the ground surface, with respect to a permanent benchmark.
- j) Indicate the depth and elevation of the upper boundary of each successive soil strata.

- k) Describe the soil samples in order of:
 - 1. Relative density or consistency (dense sand or hard clay).
 - 2. Color (Brown or Gray).
 - 3. Special adjective that is pertinent (varved or organic).
 - 4. Geological origin of soil, if known (loessial or glacial till).
 - 5. Textural classification according to the Illinois triangular diagram, with the main portion in capital letters (silty, sandy CLAY).
 - 6. If a core barrel is used to sample rock, the word (core) in parentheses, should follow the classification.
 - 7. Other items of importance; such as, hair cracks, shells, or wood chips should be indicated.
- l) Indicate the SPT blow count (N-Value), in blows per 12 in. penetration.
- m) Indicate the Q_u in tsf, to the nearest 0.1 tsf. For a bulge type failure, add the letter B; for a shear type failure, add the letter S; for an estimated value, add the letter E; for a pp reading, add the letter P.
- n) Indicate the moisture content [by percent of oven dry mass (weight)] from laboratory analysis.
- o) Describe the rock cores as follows:
 - 1. The standard size of the core barrel (BX, NX, etc.).
 - 2. The core recovery ratio, %.
 - 3. The rock quality designation (RQD), %.
- p) If peat or rock soundings have been made in certain areas, the profile of the base of the peat, or top of rock should be shown along a centerline of each pavement, within the improvement. An additional sheet should be attached for these areas. The sheet should show profiles of rock surface, or base of peat with the profiles oriented transverse to the centerline, of the improvement. An addendum should be provided to show the amount of estimated peat, or rock excavation necessary, for the proposed improvement.

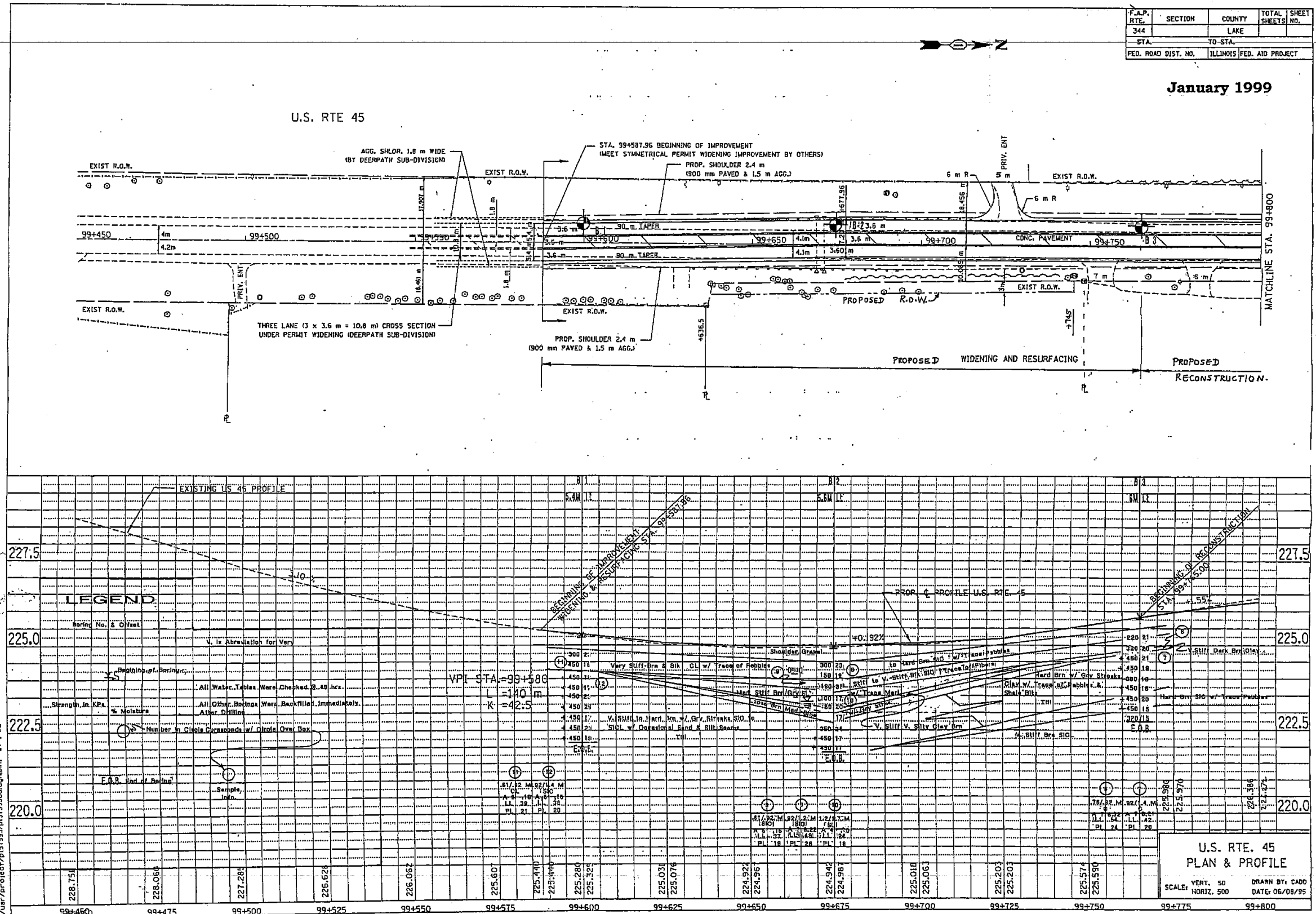

Figure 7.3.3.11.2-1(a) Example Boring Plan and Soil Profile

This page left intentionally blank.

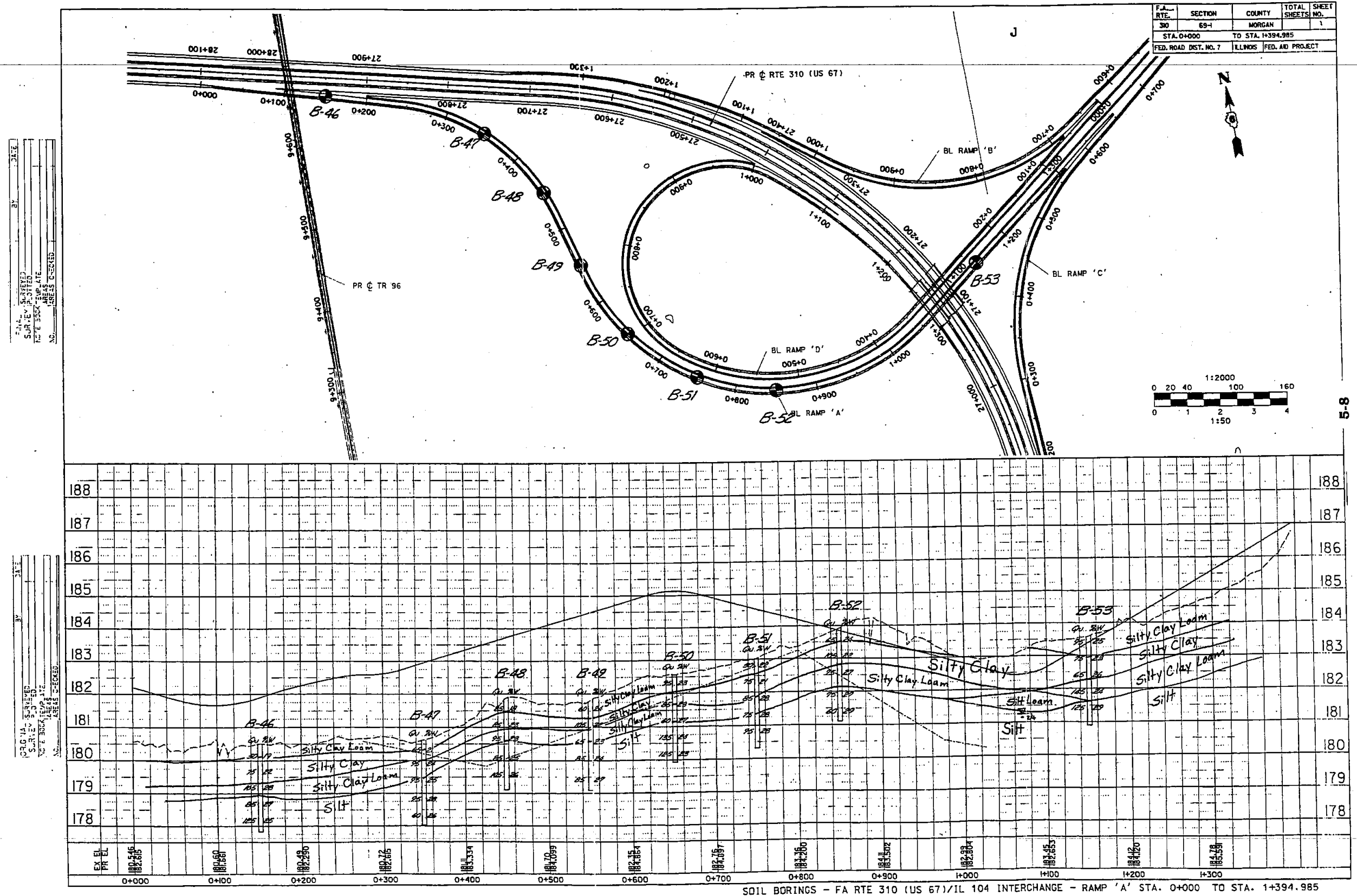

Figure 7.3.3.11.2-1(b) Example Boring Plan and Soil Profile

This page left intentionally blank.

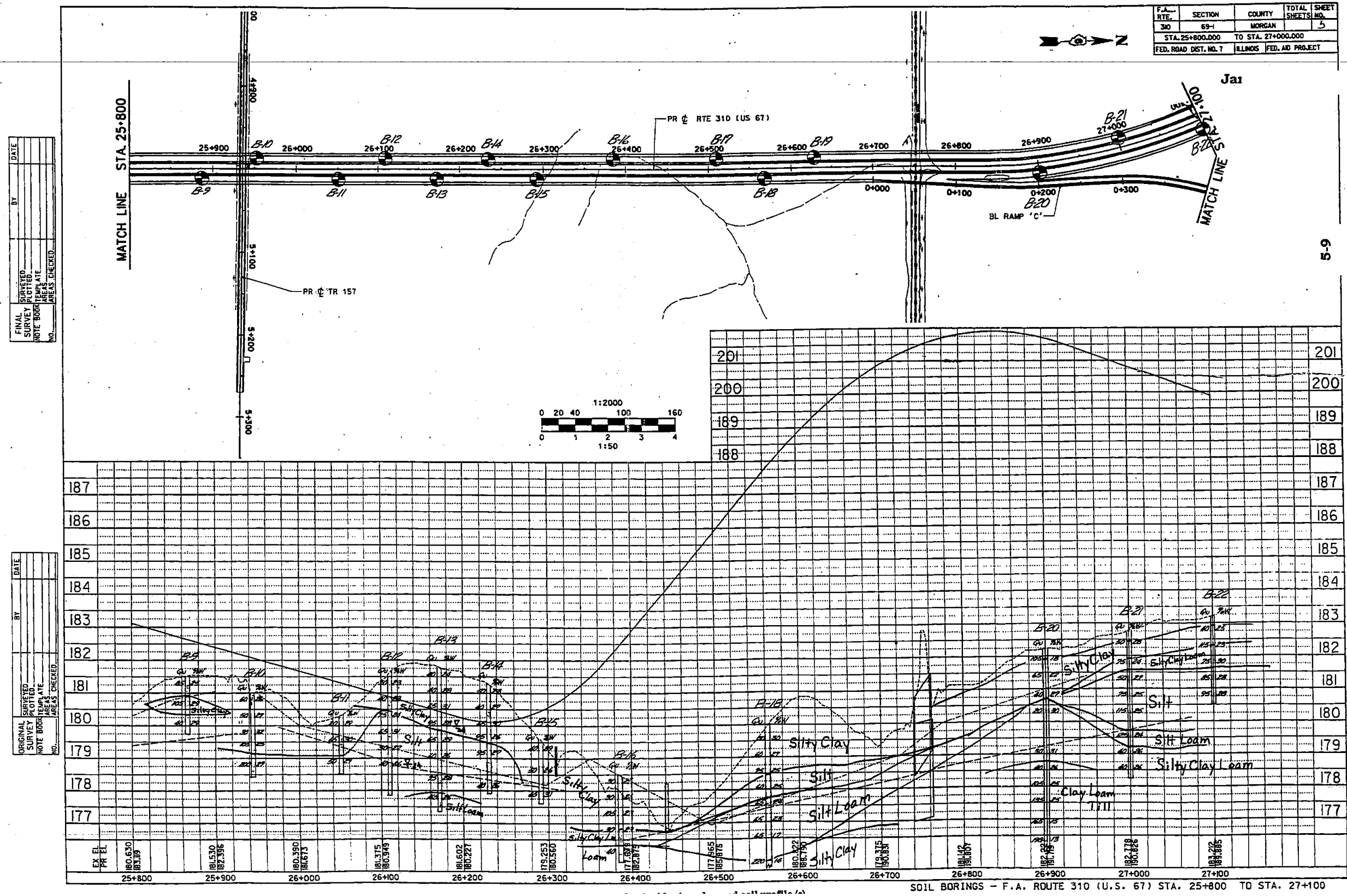

Figure 7.3.3.11.2-1(c) Example Boring Plan and Soil Profile

This page left intentionally blank.

7.3.3.11.3 Boring Logs

For locations where borings have been made for the proposed structures, or for stability computations with respect to deep cuts or high embankments, the information obtained should be summarized on a soil boring log, as shown in [Figure 4.4.7.1.2-1](#). Form [BBS 137](#) should be used for reporting the final typed soil boring logs, and they shall contain the information listed in [Section 4.4.7.1.2](#). For rock core information, form [BBS 138](#) should be used for reporting the final typed rock core logs, and they shall contain the information discussed in [Section 4.4.7.1.3](#). For criteria on reporting the final typed Shelby tube boring logs, refer to [Section 4.4.7.1.4](#).

7.4 Structure Geotechnical Report

The purpose of a Structure Geotechnical Report (SGR) is to identify and communicate geotechnical considerations and foundation design recommendations to the structural engineer so that they can be taken into account in the structure planning, final design, and/or incorporated in the contract documents. The SGR should also address construction considerations and geotechnical recommendations to be used by construction/inspection personnel or a contractor.

7.4.1 SGR Study Determination and Reporting Criteria

Four categories of SGR's have been established to match the demands of the subsurface exploration, geotechnical evaluation, and reporting content with the complexity of a project. The use of multiple SGR categories is also intended to expedite approval of the TSL and SGR by reducing SGR requirements on certain projects and deferring some requirements to the design phase.

Typically, a separate SGR is prepared for each structure requiring a Type, Size and Location (TSL) plan. The exceptions to this are structures which fall under the Borings Only (No SGR) criteria in [Table 7.4.1-1](#) and when more than one structure is combined on a TSL such as dual structures or bridges with MSE wall abutments. The general criteria for when a TSL plan is required are published in Section 2.3 of the [Bridge Manual](#). Generally, these include state owned and maintained structures such as bridges, three-sided structures, box culverts, and retaining walls. Preparation of an SGR is not generally required for local agency projects except when the project complexity and geotechnical issues are expected to be substantial or work is done within or may affect the State ROW. The structure designer, District planning and programming, or FGU may be contacted to determine if a TSL plan will be prepared, or if an SGR would be appropriate for a specific project.

The SGR category should typically be determined by evaluation of existing information following completion of the Bridge Condition Report. Such information should include anticipated structure configuration, pile driving data, existing plans, and previous and/or new boring data.

[Table 7.4.1-1](#) provides criteria to aid in determining the appropriate SGR category. For some types of structures on projects sites with no expected geotechnical challenges, **Borings Only (No SGR)** are required. For projects with few geotechnical challenges and where limited geotechnical analysis is anticipated to be adequate, an **Abbreviated SGR** is sufficient. In all other cases, a **typical SGR** will be required. A **Geotechnical Design Memorandum** is utilized when geotechnical recommendations are best developed and conveyed during the design phase development of the structure plans or when changes in scope occur.

District project development staff should coordinate with the DGE, and the consultant(s) responsible for the TSL and SGR, when appropriate, in order to determine the SGR category and scope-of-work for a project. The selected SGR category should cover all geotechnical aspects required for planning and design except when a Geotechnical Design Memorandum is specified. If during the TSL/SGR review, the scope of the selected SGR category is determined to be insufficient for planning and design, or when additional geotechnical explorations, changes in project scope, or unforeseen geotechnical work/analyses is required, the FGU will recommend a different SGR category and/or add that a Geotechnical Design Memorandum should be submitted during the design phase.

In order to avoid project delays caused by the process of obtaining a supplement, the District should allow provisional hours in the original SGR agreement to address these cases in a timely manner. As the SGR is typically completed during the planning phase along with the TSL and the Geotechnical Design Memorandum will be completed during the design phase, the provisional hours should not reflect anticipated efforts for the memorandum. Rather, man-hours for the Geotechnical Design Memorandum should be included with final design man-hours.

A detailed description of the various SGR categories is provided in [Sections 7.4.3](#) through [7.4.5](#).

Borings Only (No SGR) Criteria	Abbreviated SGR Criteria	SGR (Typical) Criteria	Geotechnical Design Memorandum Criteria
<p>Bridges with all of the following:</p> <ul style="list-style-type: none"> • Single Span • Spill thru (stub and integral) abutments • H-piles (no metal shells, spread footings, or drilled shafts) • Pile length to rock > 10 ft. & < 40 ft. • Less than 2 ft. of fill added to embankment grade or slopes • Seismic Zone 1 • No permanent cut slopes >15 ft. <p>Walls with all of the following:</p> <ul style="list-style-type: none"> • Best wall type (MSE, T-type, Soldier, etc.) seems apparent • Exposed Height < 7 ft. • Wall Foundation soils with min. $Q_u > 1.0$ tsf <p>Box Culverts with all of the following:</p> <ul style="list-style-type: none"> • Horizontal wings • Box foundation soils with $Q_u > 0.6$ tsf • No more than 1 ft. working platform under box • Fill height above box < 3 ft. <p>All Structure Types:</p> <ul style="list-style-type: none"> • No challenging staging, construction, or subsurface issues and field visit indicates no visible geotechnical problems (i.e. existing slope failures, mine subsidence, tilting abutments, retaining walls, etc.) 	<p>Bridges with:</p> <ul style="list-style-type: none"> • Best foundation type (pile, spread, or shaft) seems apparent <p>Walls with:</p> <ul style="list-style-type: none"> • Best type (MSE, T-type, Soldier, etc.) seems apparent <p>Box Culverts with:</p> <ul style="list-style-type: none"> • No more than 2 ft. of removal under box <p>3-Sided Structures with:</p> <ul style="list-style-type: none"> • Best foundation type (pile, spread, or shaft) seems apparent <p>All Structure types with all of the following:</p> <ul style="list-style-type: none"> • No liquefaction anticipated • No challenging staging or construction issues • No slope stability or settlement concerns • No ground modification expected 	<p>Structures:</p> <ul style="list-style-type: none"> • Not satisfying the “No SGR” or “Abbreviated SGR” criteria 	<p>Structures with either an Abbreviated or Typical SGR’s and any of the following:</p> <ul style="list-style-type: none"> • Drilled shaft or piles set in rock and/or subject to lateral loads • Soldier pile or sheet pile walls • Ground improvement or treatment designs/specifications • Drilled, helical, or deadman anchors • Changes to the structure requiring revised design values

Table 7.4.1-1 SGR Category Criteria

7.4.1.1 SGR Project Limits

The geotechnical exploration and evaluation conveyed in an SGR shall typically extend to the following project limits:

1. Back to back of a bridge's approach slabs including bridge cone side and end slopes.
2. End to end of a retaining wall including the soil slopes in front of and behind the wall.
3. Out to out of headwalls of existing and proposed three sided structures or box culverts including wingwalls and the excavation and backfill limits on both sides.

The project limits reflected in the SGR may be adjusted, as appropriate, for a particular project and should be coordinated with the RGR accordingly.

7.4.2 Submittal and Review Process

A flowchart of the submittal and review process for evaluation of geotechnical adequacy of structures is shown in [Figure 7.4.2-1](#).

For state projects, one hard copy of the soil borings (when no SGR is required), Abbreviated SGR, or typical SGR shall be submitted to the BBS Planning Unit with the TSL Plan. The SGR, along with the geotechnical aspects of the TSL plan, are reviewed by the FGU and comments pertaining to the geotechnical adequacy of the TSL are provided to the Planning Unit. An SGR Speed Letter will be addressed to the TSL Consultant along with copies to the SGR author, District Geotechnical Engineer, and District Studies and Plans Section, indicating "Approved as Submitted", "Approved Subject to Changes", or "Returned for Revisions".

When substantial changes to the TSL are needed, the BBS Planning Unit will reject the TSL, resulting in the SGR being "Returned for Revisions" to make sure that any changes to the TSL and SGR recommendations are incorporated and resubmitted for further review. Once the TSL is approved by the BBS Planning Unit, the revised SGR is either "Returned for Revisions" or "Approved Subject to Changes". In either case, the TSL consultant needs to work with the SGR author and email the revised SGR to the FGU so that an "Approved as Submitted" Speed Letter can be issued.

Once the SGR approval is issued, any additional requests by the final design consultant for information and analysis from the SGR author is provided through a Geotechnical Design Memorandum(a). One hard copy shall accompany the Final Plans submittal to the BBS and evaluated by the FGU during the final design review. Geotechnical Design Memoranda are assumed adequate unless otherwise noted in the BBS Design Unit Final Plans approval Speed Letter.

For projects being processed through the Bureau of Local Roads and Streets, a Preliminary Bridge Design and Hydraulic Report (PBDHR), containing a TSL, soil borings, and an SGR (when required), is submitted to the BBS Local Bridge Unit (LBU). The FGU will review the boring data (when no SGR is required), Abbreviated SGR, or typical SGR, as well as the geotechnical aspects of the TSL plan and provide review comments to the LBU. The FGU comments are transmitted to the consultant with the LBU comments through the District's Local Roads and Streets Section; however, no formal SGR approval is required or provided.

Cover sheets for SGRs shall always contain both the original date and any revised date(s). All SGRs and Geotechnical Design Memoranda prepared by consultants shall contain the author's Illinois Licensed Professional Engineer's seal.

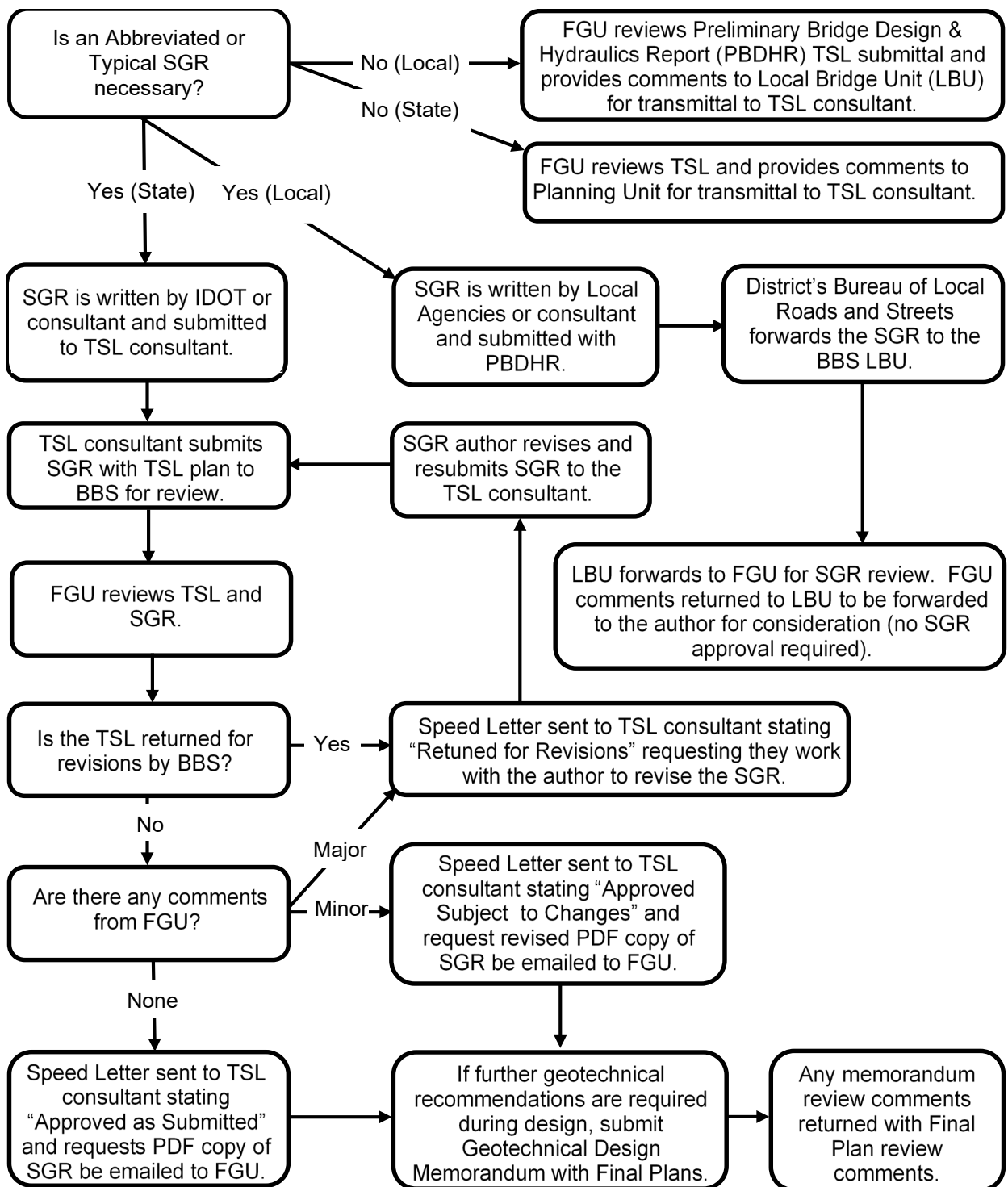

Figure 7.4.2-1 SGR Submittal and Review Process

7.4.3 Borings Only (No SGR Required)

This category can be selected when the criteria noted in [Table 7.4.1-1](#) are met for a specific project and, therefore, no SGR will be required by the BBS. In this case, the structural engineer will be responsible for all geotechnical aspects of the project during the planning and design phases. In particular, the following are geotechnical issues which will be considered part of the structural engineer's scope:

- Evaluation of the existing data (borings, plans, pile data, etc.) considering the expected type of substructure and locations in order to determine the need for further exploration and testing.
- Selection of the proper foundation/wall to be shown on the TSL.
- Determination of all geotechnical design parameters and completion of the foundation/wall design satisfying AASHTO and IDOT policies.

When new borings are obtained for this category, a project location map and plan view drawing showing the boring locations shall be submitted with the boring logs. Form [BBS 137](#) should be used for reporting the final typed soil boring logs, and they shall contain the information listed in [Section 4.4.7.1.2](#). For rock core information, form [BBS 138](#) should be used for reporting the final typed rock core logs, and they shall contain the information discussed in [Section 4.4.7.1.3](#).

7.4.4 Abbreviated SGR

For projects anticipated to meet the criteria for an Abbreviated SGR in [Table 7.4.1-1](#), a scope-of-work should be developed to address the basic/key geotechnical elements necessary for proper planning and design of the proposed structure. The intent is to allow Districts to select a limited SGR category/scope when it is anticipated that extensive geotechnical effort (exploration, analyses, reporting, etc.) will not be required.

To initiate development of an Abbreviated SGR, the geotechnical engineer should obtain the general structure plan and elevation configuration, preliminary substructure types, locations, and factored loadings, Hydraulic Report scour depths, existing borings and plans, and any other information or direction provided by the District or structural engineer. The geotechnical engineer then reviews this data, performs the necessary analysis, and prepares any attachments necessary to document the geotechnical engineer's professional evaluation of the key areas

indicated on IDOT form [BBS 132](#). The following outline describes the content and scope of the Abbreviated SGR indicated on IDOT form [BBS 132](#).

- **Project Description and Scope:** Indicate the proposed structure type, substructure types, and foundation locations. Attach plan and elevation drawings of the proposed structure.
- **Subsurface Conditions:** Evaluate the existing data (borings, plans, pile data, etc.) and new subsurface exploration data to determine the need for further exploration and testing. For drilled shaft and top-down excavated retaining wall/soil retention systems, verify that boring 24 hour delayed groundwater level data (or equivalent) is provided. Request additional soils or rock data with an SGR Technical Memo. Provide the boring logs ([Section 4.4.7.1](#)) and a Subsurface Data Profile Plot ([Section 7.4.5.7](#)) of all boring and test data as attachments.
- **Settlement:** Indicate the amount of new soil or structure loading that could cause settlement. Estimate the amount and time of any expected settlement. Confirm that no further testing, analysis, or ground improvement/treatment design is necessary.
- **Slope Stability:** Identify areas of new slopes (cut or fill). Estimate the proposed slopes' factor of safety. Confirm that no further testing, analysis, or ground improvement/treatment design is necessary.
- **Scour:** Report the deepest scour depths indicated in the Hydraulic Report for the Strength Limit State (typically the 100-year event unless lower flows cause deeper scour) and the Extreme Event Limit State (typically the 200-year event unless lower flows cause deeper scour). Apply the non-granular scour depth reductions in accordance with [Bridge Manual](#) Section 2.3.6.3.2 and indicate the Q100 and Q200 scour elevations at each substructure.
- **Seismic Considerations:** For bridges and three-sided structures, determine the soil Seismic Site Class Definition, the corresponding 0.2 and 1.0 second horizontal response spectral acceleration coefficients, and Seismic Performance Zone. Confirm that the soils are not liquefiable. Box culverts and retaining walls are not typically designed for seismic loading, and as such, seismic design parameters should on not be provided in Abbreviated SGRs for these types of structures.

- Foundation Recommendations: Confirm the feasibility of the proposed foundation/wall type. Provide the design parameters and recommendations for the selected foundation/wall type. The data that should be provided for a foundation type is described below and should be provided only for the apparent most cost effective foundation type at each substructure.
 1. For piles, provide a Pile Design Table for each substructure indicating all feasible pile types, a wide range of factored pile resistances available, the corresponding nominal required bearings and estimated pile lengths for each. The range of factored pile resistances available should be selected using the preliminary factored loadings obtained from the structural engineer and consider the maximum and minimum pile spacing possible. The range of nominal required bearings should extend to the IDOT maximums unless concern for damage suggests restricting the maximum to a lower value.
 2. For spread footings, provide factored bearing resistance and unit sliding resistance at various elevations. Confirm that no ground improvement/treatment is necessary.
 3. For drilled shafts, provide estimated top of rock elevations, the maximum estimated groundwater elevation, as well as preliminary estimates of side and base resistance.
 4. For box culverts and retaining walls, confirm the feasibility of the proposed wing or wall type and provide the necessary design parameters.
- EWSE/Cofferdams: Obtain the estimated water surface elevation (EWSE) and determine the need for cofferdams, the type of cofferdam(s) (Type 1 or 2), and if a seal coat will be necessary.
- Construction Considerations: Assess the need and feasibility of using a temporary construction slope, or if sheeting/soil retention will be necessary. When use of construction slopes is not possible, determine if the temporary sheet piling design charts can be used to provide a design or if a temporary soil retention system will need to be specified.

7.4.5 SGR (Typical)

For projects where an Abbreviated SGR is not expected to provide adequate geotechnical input to properly plan and design a cost effective feasible structure, a typical SGR should be developed. The following outline shall be followed for a typical SGR in order to establish uniformity of format.

- Cover Sheet and Table of Contents
- Project Description and Scope
- Field Exploration
- Geotechnical Evaluations
- Foundation Recommendations
- Construction Considerations
- Appendices (Supporting Documentation): location map, boring plan, subsurface data profile, boring logs, laboratory test results, photographs, settlement and slope stability calculations, etc.

This outline should be divided up into additional sub-sections as described below and indicated in the example table of contents shown in [Table 7.4.5-1](#). Due to the fact that project size and scope-of-work can vary, it is anticipated that information requested in some sections may not apply to a given project or that additional information may need to be added. The following sections describe the typical SGR content and scope.

7.4.5.1 Cover Sheet and Table of Contents

Indicate the route, section, county, existing and proposed structure numbers, original and revised (when applicable) report dates, as well as the name, email address, and phone number of the SGR author on the cover sheet. Following the cover sheet, provide a table of contents indicating the subsequent sections and attachments.

7.4.5.2 Project Description and Scope

Provide information on the preliminary structure, layout, factored loadings, wall height, existing borings and plans, and any other information or direction provided by the District or structural engineer.

<u>Table of Contents</u>	
Project Description and Scope	1
Field Exploration	2
Subsurface Exploration and Testing	2
Subsurface Conditions	3
Geotechnical Evaluations and Recommendations	4
Settlement	4
Slope Stability	5
Scour	6
Seismic Considerations	6
Foundation Recommendations	7
Spread Footing	7
Driven Piles	7
Drilled Shafts	8
Lateral Load Analysis	9
Construction Considerations	10
Temporary Soil Retention System/Sheet Piling	10
Cofferdams/Seal Coat	10
Drilled Shaft Construction	11
Appendices	12
Location Map	
Boring Plan	
Preliminary TSL	
Subsurface Data Profile Plot	
Soil Boring and Rock Core Logs	
Rock Core Photos	
Laboratory Test Results	

Table 7.4.5-1 Example SGR Table of Contents

7.4.5.3 Field Exploration

The field exploration section of the SGR should include a detailed discussion of the soils encountered and the field conditions during the exploration. Provide discussions of the subsurface exploration and characterize the general subsurface conditions as indicated below.

- **Subsurface Exploration and Testing:** The SGR should indicate the date on which the field exploration was made, as well as information about any other explorations or investigations conducted. A general description of the terrain should be included, with special emphasis on drainage and erosion patterns. Any conditions of high water and flooding, etc., which may have been noted during the exploration and might be of value in the design of bridges and culverts, should also be noted. Also, the Report should present a brief discussion of the type of drilling equipment, used during the exploration, and the hammer type, drilling method and casing depth, if any; all with reference to applicable AASHTO or ASTM standard methods/guidelines for conducting subsurface investigations.

When a Geotechnical Design Memorandum is anticipated for to provide geotechnical recommendations which are best developed and conveyed during the design and development of the structure plans, make any recommendations for additional exploration/testing which would be necessary to complete this work at such time.

- **Subsurface Conditions:** Provide a general description of the soil and rock encountered. This should consist of a summary of the soils and bedrock conditions, which exist within the area of the proposed improvement. A description of groundwater conditions recorded in the borings or from any groundwater monitoring wells or piezometers shall also be included. (For drilled shaft and top-down excavated retaining wall/soil retention systems, boring 24 hour delayed groundwater level data (or equivalent) is important for design and construction.) Reference to the boring plan, subsurface data profile, and boring logs should be included in this section. Guidelines for preparing the a subsurface data profile plot(s) is provided in [Section 7.4.5.7](#).

7.4.5.4 Geotechnical Evaluations and Recommendations

Provide a discussion of the geotechnical analysis and design parameters that are independent of the foundation type(s) being considered for a structure as indicated below.

- **Settlement:** Indicate the amount of new soil or structure loading that could cause settlement. Provide estimates of the settlement amount and time (t_{90}) and determine whether the estimated settlement is expected to impact the roadway or structure design. When the impact is unacceptable, evaluate the feasibility of various treatment options. When costly treatments or unacceptable delays in the construction schedule are anticipated, the settlement analysis shall utilize soil parameters determined from laboratory testing of intact (relatively undisturbed) samples.
- **Slope Stability:** Describe any existing slopes at the site (heights and angles) and indicate any proposed changes such as fills, cuts, or other modification that might affect stability of the slopes. Determine the critical FOS against slope failure. If the FOS is inadequate, discuss the potential impact of slope failure on the structure and evaluate various treatment options. If costly ground improvement/treatments are recommended, the stability analysis shall utilize soil parameters determined from laboratory testing of intact (relatively undisturbed) samples.
- **Scour:** For bridges and three sided structures only, report the deepest scour depths indicated in the Hydraulic Report for the Strength Limit State (typically the 100-year event unless lower flows cause deeper scour) and the Extreme Event Limit State (typically the 200-year event unless lower flows cause deeper scour). Apply the non-granular scour depth reductions, in accordance with [Bridge Manual](#) Section 2.3.6.3.2, to these depths and note any scour countermeasure recommended in the Hydraulic Report or by the structure planner. Indicate the Q100 and Q200 scour elevations at each substructure to be shown on the TSL. Evaluate and report how the final scour depths will impact loss in capacity and lateral stability in the foundation design recommendations.
- **Seismic Considerations:** For bridges and three-sided structures, determine the soil Seismic Site Class Definition, the corresponding 0.2 and 1.0 second horizontal response spectral acceleration coefficients, and Seismic Performance Zone. Determine if seismic slope stability and/or liquefaction analyses are necessary for the site's seismic

performance zone. Conduct analyses, if needed, and propose any necessary treatment and/or account for their effects in the foundation design recommendations. Box culverts and retaining walls are not typically designed for seismic loading, and as such, seismic design parameters should on not be provided in SGRs for these types of structures.

7.4.5.5 Foundation Recommendations

The foundation design recommendations that should be discussed in the SGR vary by structure type, foundation type, and site conditions. The following discussions provide guidance on information that should be considered for inclusion in the SGR.

- **Bridges:** For Bridges, the SGR design recommendations shall evaluate the feasibility of the various foundation types at each substructure. Discuss any differences between the alternatives in terms of constructability, construction time, equipment access, or performance to allow the planner to select the most cost effective and appropriate foundation type and treatment found feasible in the SGR. The requirements for spread footings, piles and drilled shafts are discussed below.
 1. **Spread Footings:** When spread footings are considered a feasible alternative, the SGR shall provide a table indicating the factored bearing and sliding resistances at the corresponding footing elevation(s) for each substructure unit considering frost, scour, minimum soil/rock embedment, footing shape, expected loadings, or other issues. Indicate any key assumptions used to determine the bearing and sliding resistances provided. When remedial treatments such as removal and replacement of unsuitable material, silt or shale mud slab seal, shear key, or other ground improvement are required to obtain the necessary bearing or sliding resistance, details of these treatments shall also be provided. Sliding resistance can be provided in terms of the coefficient of friction, adhesion, passive pressure, or minimum embedment in rock to allow the structural engineer to size and detail the footing for the final design loadings.
 2. **Piles:** Provide a Pile Design Table for all feasible pile types, indicating a wide range of factored pile resistances available, the corresponding nominal required bearings and estimated lengths for each. The range of factored pile resistances available should be selected using the obtained preliminary factored loadings and consider the maximum and minimum pile spacing possible. The range of nominal required bearings

should extend to the IDOT maximums unless concern for damage suggests restricting the maximum to a lower value. In addition, indicate any key assumptions made in developing the tables such as assumed pile cutoff elevations, bottom of substructure/ground surface during driving elevations, etc. The tables should reflect any reductions in resistances resulting from geotechnical losses such as negative skin friction, liquefaction, or scour. When applicable, provide possible treatment options to avoid such reductions and allow the planner to determine if the expense of the treatment is justified. The substructures where test piles are deemed necessary, the need for metal shoes, the elevation and diameter of any pre-coring, and minimum pile length for scour or pile fixity shall also be documented. When recommending piles that are drilled and set into rock, provide the same information described below for drilled shafts, particularly the estimated top of rock, and the unit factored side and end bearing resistances.

3. **Drilled Shafts:** When subsurface conditions, site limitations, or structure type indicate that drilled shafts are feasible and possibly the most cost effective foundation type, design recommendations shall be provided. Recommendations shall include preliminary estimated factored side resistance values for each layer and preliminary factored end bearing resistance values at potential tip elevations so that the planner can estimate the number, diameter, and depth of the shafts. The estimated top of rock elevations at each substructure and the maximum estimated groundwater elevation shall be provided. In addition, the feasibility of bellling and effect of downdrag, liquefaction, or scour on the vertical and lateral capacities should be addressed.
- **Box Culverts:** For CIP and Precast Box Culverts, the SGR design recommendations shall address the potential for differential settlement, feasible wingwall types, and constructability. Changes in loading below and adjacent to the proposed culvert (considering the locations of the existing structure, existing fill, and new fill) should be compared to soil moisture content in order to provide estimates of differential settlement along the culvert. Authors should consider differential settlement for cases such as between construction stages, between an existing culvert and extensions, and between fill over and adjacent to the culvert. The planner will evaluate the culvert or roadway's ability to tolerate the settlement. However, if settlement is too large or abrupt, the SGR should also provide possible treatment options such as settlement collars (indicate locations and heights), removal and replacement of unsuitable material, waiting period,

and preloading. Constructability evaluations shall verify that the soils permeability will allow water diversion and construction in the dry. In addition, when silty soils or low strength clay soils are expected to be present at the bottom of the culvert, a working platform of coarse aggregate up to 2 ft. thick may be recommended in order to provide a level and stable surface to construct the bottom slab. [Table 8.9-1](#) can be referred to for guidance on estimating thicknesses of working platforms.

- **Three-Sided Structures:** For Three-Sided Structures, the SGR design recommendations shall contain the anticipated vertical and horizontal structure loadings on each leg and provide recommendations of feasible foundation types that appear to be cost effective. The foundation design parameters shall be provided for any foundation types considered by the structure planner to be viable options. Provide recommendations regarding wingwall type, water diversion/constructability, and scour depths (total and adjusted) unless counter measures are proposed by the hydraulic engineer.
- **Retaining Walls:** For Retaining Walls, evaluate the feasibility of various wall types considering the project design constraints, cross sections, preliminary wall size/location information, and subsurface conditions. Discuss wall and foundation types which are feasible and appear to be cost effective, noting any required ground treatment, and provide design parameters for each option being considered by the planning engineer. When anchored walls are an option, discuss the feasibility of using various types of deadman, helical, or permanent ground anchors.

7.4.5.6 Construction Considerations

Discuss construction considerations including the need for any temporary soil retention versus using temporary soil slopes. Recommend use of cantilevered temporary sheet piling, when feasible, according to the [Bridge Manual](#) design guide charts, or note that the IDOT “temporary soil retention system” construction specification will be necessary. In addition, in stage construction fills, recommend use of a temporary geotextile wall or temporary MSE wall where appropriate and feasible. Discuss the need for a Type 1 or Type 2 cofferdam based on the EWSE at the various substructures. Recommend either a minimum tip elevation that can seal the excavation or the need for a seal coat for Type 2 cofferdams.

7.4.5.7 Appendices (Supporting Documentation)

The Report appendices shall contain all geotechnical data and supporting documentation. This includes a project location map, boring plan, subsurface data profile plot, existing and new soil boring logs, rock core logs, core pictures, Shelby tube boring logs, Shelby tube test data sheets, and other laboratory test results. Refer to [Section 4.4.7.1.2](#), [Section 4.4.7.1.3](#), and [Section 4.4.7.1.4](#), for criteria on reporting the final typed soil boring logs, rock core logs, and Shelby tube boring logs respectively.

The “subsurface data profile” plot shall be developed using a format with legible fonts that allows it to be incorporated into the plans instead of the boring logs. The plot shall present the data in columns, sequenced by station, and to scale in the elevation axis so that variations in soil type, water table, and ground surface or rock profile can easily be observed during design and construction. Within the extent of the borings and structure, the approximate existing grade and proposed ground surface lines, as well as the bottom of substructure locations and elevations, should also be plotted. [Figure 7.4.5.7-1](#) shows an example of a subsurface data profile plot, and Section 3.1.11 of the [Bridge Manual](#) may be referenced for additional information on subsurface data profile plots.

Additionally, this section shall contain only the critical computations necessary to support the major design recommendations made in the SGR and document design parameters, analysis methods, and insights behind how judgments were made. Analyses such as settlement, stability, pile length, shaft resistance, footing capacity, downdrag, scour, liquefaction, removal depth, replacement material strength, wick drain spacing, preloading, and wall feasibility may be provided only when they form the basis for key decisions. Do not include computations when the recommendations are non-controversial, or the reasoning is readily apparent.

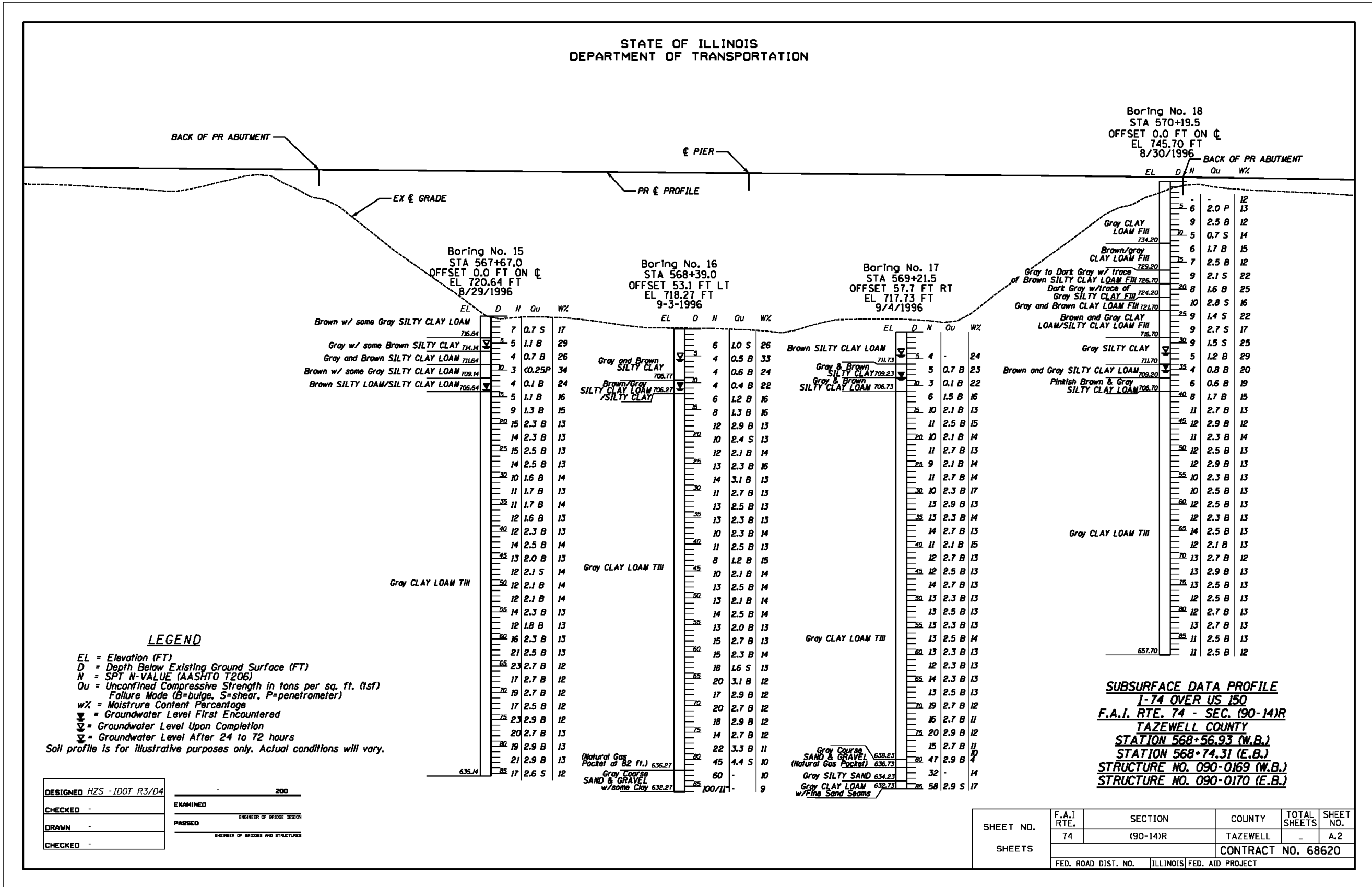

Figure 7.4.5.7-1 Example Subsurface Data Profile Plot

This page left intentionally blank.

7.4.6 Geotechnical Design Memorandum

When a project is anticipated to meet the criteria requiring a Geotechnical Design Memorandum in [Table 7.4.1-1](#) and both the SGR and memo are prepared by a consultant, the geotechnical scope-of-work should include design assistance, review, and recommendations by the SGR author for preparation of a Geotechnical Design Memorandum. The structural engineer will contact the SGR author to discuss providing all geotechnical design parameters necessary to complete the Final Plans. The following discussion describes the general content and scope of a Geotechnical Design Memorandum.

- **Piles or Drilled Shafts Subject to Substantial Lateral Loads:** When driven pile embedments are insufficient to provide adequate fixity or lateral capacity (often due to deep scour or shallow bedrock), either drilling and setting piles in rock or drilled shafts (either in soil or socked in rock) are commonly selected by the planner. Any capacity values provided in the SGR for these foundation types are only preliminary estimates using approximate foundation loadings and configurations, and soil/rock test data available prior to TSL completion. The Geotechnical Design Memorandum provides the geotechnical engineer the opportunity to offer less conservative recommendations using more specific information available during the final design phase. Specifically, by using the final loadings, shaft/pile spacing, and shaft diameter provided by the structural designer along with any additional testing that was not available during SGR development; the required minimum tip elevation in soil or embedment in rock can be finalized in this document. The SGR author should also discuss any needs, questions, or concerns the designer may have and address them in this document.

The Geotechnical Design Memorandum author should obtain the lateral loading(s), pile head conditions, and pile/shaft size(s) being considered so that lateral load analyses can be performed, and the results provided in the memorandum. Programs such as COM624, L-Pile, or FB MultiPier which all use nonlinear soil springs and the deflection of the pile/shaft, should be used to model the foundation behavior as lateral loading is applied. The analysis shall provide the pile head deflection(s) and maximum moment(s) to the structural designer. If the deflection or moment is unacceptable, the number or size of the piles/shafts may need to be revised and the analysis rerun. Seismic designs typically use assumed pile/shaft fixities at each substructure unit in order to determine substructure loadings as well as preliminary pile/shaft numbers and sizes. During the corresponding

lateral loading analysis, the results often show different substructure stiffnesses should be used, which generates revised loadings and requires re-analysis until assumed conditions agree with the lateral loading analysis. In cases where the size of piles/shafts are not changing, a series of increasing lateral loadings can be applied to allow the corresponding increasing deflections and moments to be plotted and provided for less iteration. Group effects using the designer's final spacing should also be taken into account during the lateral loading analysis.

- **Soldier Pile or Sheet Pile walls:** The Geotechnical Design Memorandum author shall obtain the final wall heights, slope geometry in front of and behind the wall, and any surcharges that may exist from the structure designer. Using this information, the soil boring data, and any new data that may have been obtained since the TSL/SGR approval, the author shall develop and provide the design earth pressures in front of and behind the wall. The methods, equations, and parameters used to obtain the design earth pressures recommendations shall be documented as well as any assumptions made. When deflection is a concern, the Geotechnical Design Memorandum shall provide soil parameters for the designer to use in computing the wall deflection and/or provide analysis results using programs that considers the p-y behavior of soil and rock. For sheet pile walls driven deep or into stiff or dense soils, the memorandum shall document the minimum sheet size that can be driven to the final design tip elevation without damage. In the case of soldier piles, the structural engineer will determine the tip elevations, pile size, and spacing. However, it is helpful to conduct some analyses in order to verify if the recommended pressures will result in a reasonable section modulus, tip elevation, and pile spacing.
- **Ground Improvement:** Since the SGR and TSL only show the improvement type, the specific limits and/or design of the ground improvement should be provided during the design phase. The final structure and embankment configurations or footing loadings should be provided to the Geotechnical Design Memorandum author so that the final limits and/or final design can be provided to the structural designer for inclusion in the final plans. In the case of aggregate column ground improvement, the estimated treatment limits shall be provided. Since the specialty contractor provides the design, the author shall work with the designer to recommend and document the performance requirements of the project (for settlement, bearing capacity, slope stability, etc.) To accomplish this, the author may contact vendors and/or various specialty contractors in order to draw on their expertise

and experience with similar subsurface conditions such that achievement of the performance requirements in the project-specific conditions is ensured. However, the location and identity of the project shall be withheld in all communications with such vendors and specialty contractors. The Geotechnical Design Memorandum shall provide the minimum required depths and spacing of any treatments such as wick drains, deep soil mixing, jet grouting, etc. Recommendations for removal and replacement of unsuitable material or load balancing, with or without lightweight fill, shall be provided. Specifically, the depths and horizontal limits shall be finalized based on the performance objectives provided by the designer. Acceptable IDOT aggregates shall be specified, and when lightweight material is to be employed, the type and limits where it will be required shall also be provided in the Geotechnical Design Memorandum. The memorandum shall note the IDOT special provision that is required or assist in the development of a project specific special provision. The memorandum should also include recommendations for monitoring instrumentation such as settlement plates, piezometers, etc.

- For permanent ground anchors, helical anchors, and deadman anchors, the Geotechnical Design Memorandum shall provide the proper location(s) and capacity for the anchors in order to provide adequate global stability. Using the anchor elevations and anchor loadings obtained from the structure designer, the minimum unbonded length and estimated bonded length shall be provided for permanent ground anchors in order to ensure the anchorage is occurring beyond the design earth pressure failure surface. For helical anchors, the minimum extension length and estimated helical length shall be provided. For both of these anchor types, the memorandum shall recommend an angle of inclination that would put the bonded/helical zone in the strongest soil or rock based on the existing and any new soils data.

For deadman anchors, the memorandum shall locate the deadman in order to limit the amount of interaction between the design earth pressure failure surface and the anchor's passive failure surface. Unlike permanent ground and helical anchors, which are sized by a contractor and tested in the field, the deadman anchor (timber, concrete, sheet pile, drilled shaft, etc.) is selected and the factored resistance/capacity is determined during the design phase. As such, the memorandum shall provide the earth pressure to be used, or provide the size based on the loading and deadman type determined to be most cost effective.

For all anchor types, the memorandum shall note the IDOT special provision typically used or assist in development of a project specific special provision, when necessary

7.5 Special Investigations

There are several types of explorations which fall under Special Investigations as outlined in [Section 3.4.4](#). Some of these categories such as Shelby tube borings and peat or rock sounding may be incorporated into an RGR or SGR to address localized conditions. Other categories such as traffic and sign structure borings are processed by the Department separately from other design elements and as such do not require full Geotechnical Reports. Reporting for a particular Special Investigations topic should be as appropriate to the specific task and can range from simple boring logs and test results to memorandums or reports. Geotechnical studies for pavement rubblization projects are an example of a specialized study for which a report is necessary to document and convey the findings.

7.5.1 Pavement Rubblization Geotechnical Report

The findings of a “detailed pavement and subsurface” exploration discussed in Section 54-5.03(b) of the [BDE Manual](#) to assess the feasibility of rubblizing a roadway are reported in a Pavement Rubblization Geotechnical Report. The Report content required under Section 54-5.03(b) of the [BDE Manual](#) includes the following:

- existing typical pavement section(s)
- core soundness and condition
- summarized results of subsurface investigation
- data plotted on Subgrade Rubblizing Guide (Figure 54-5.T of the [BDE Manual](#))
- number and locations of transitions to meet mainline structures
- clearances for overheads
- utilities and culverts
- location of any buildings or structures within 50 ft. of the rubblization
- location and condition of underdrains

The Report shall also include:

- cover sheet and table of contents as outlined in [Section 7.3.3.1](#)
- introduction, project description, and scope discussion as outlined in [Section 7.3.3.2](#)
- assessment of feasibility for performing rubblization
- summary of area(s) which may require remedial treatment (including a table listing estimates of treatment limits: stations, offsets, depths, type of treatment)
- project location map
- plan view of pavement core locations
- all field and lab data:
 - photos of the pavement cores showing a tape measure scale of the core length and identification of the project and core location (station and offset)
 - pavement core data/logs which may be summarized on form [BC 334](#)
 - DCP test records/logs
 - laboratory soil test results which may be summarized on form [BMPR 508A](#)

Use the RGR submittal and review process outlined in [Section 7.3.2](#).

This page left intentionally blank.

Chapter 8 Geotechnical Construction Inspection

8.1 Introduction

In addition to the work of soil engineering carried on during the planning and design stage, consideration must be given to soil problems which may arise during construction. Also, checks must be made to determine whether or not soil conditions encountered in construction correspond to those visualized in the original design. Of particular importance are:

- Control of the embankment construction, as well as placement of any special backfill.
- Inspection of the subgrade before placing any components of the pavement structure.
- Control of any soil stabilization process that may be specified.

Whether or not these duties are carried out specifically by an engineer with training and experience in the soils field, they have soil engineering implications. Proper performance of the finished improvement depends on the early recognition of possible problems and the utilization of soils personnel to advise, as necessary, in the prevention of detrimental situations.

The purpose of this chapter is to: 1) broadly describe the area of responsibility of the DGE, or his/her field inspection personnel; 2) delineate some of those construction problems directly related to the soils in subgrades, embankments, and structures; and 3) describe the characteristics by which the problems may be recognized. It is also the intent of this chapter to serve as an informative reference material, for the RE to be aware of such possible soil problems. The DGE should ensure that such information reaches the RE, through proper communication. Written communication on critical issues is important.

Geotechnical Manual

Chapter 8 Geotechnical Construction Inspection

When performing geotechnical construction inspection and testing, the RE and the soils Inspectors must read and thoroughly understand the following documents:

- Contract Documents
 - The [Standard Specifications](#)
 - The [Supplemental Specifications & Recurring Special Provisions](#)
 - All Contract Special Provisions and general plan notes pertaining to earth work and geotechnical concerns
 - Plans
- Reference Documents
 - Geotechnical Report(s) that has/have been prepared for the improvement
 - IDOT's [Construction Manual](#)
 - Applicable [Construction Inspector Checklists](#)
 - IDOT's [Subgrade Stability Manual](#)
 - IDOT's *Geotechnical Manual* (this Chapter)
 - IDOT's [Project Procedures Guide \(PPG\)](#)
 - All necessary Standard Test Procedures including the *Manual of Test Procedures for Materials* (<http://www.idot.illinois.gov/doing-business/material-approvals/soils/index>, located under the “References” tab, and then under the “Manuals” drop down button.)
 - STTP course reference manuals, as applicable

8.2 Construction Inspection Training

IDOT has a Specific Task Training Program (STTP) that provides basic guidance to construction and materials personnel involved in field testing and inspection. These courses are designed to convey the latest policies and procedures for a specific task.

The following STTP courses focus on inspection of soil and foundation construction:

- STTP S-19: Pile Foundation Construction Inspection
- STTP S-32: Drilled Shaft Foundation Construction Inspection
- STTP S-33: Soils Field Testing and Inspection
- STTP S-34: Radiation Safety and Density by the Nuclear Method

Geotechnical Manual

Chapter 8 Geotechnical Construction Inspection

For personnel involved in the field testing of soils, successful completion of STTP S-33 is required by IDOT Policy MAT-15, "Quality Assurance Procedures for Construction" as part of the IDOT process for compliance with the Code of Federal Regulations, 23 CFR 637.

Subsequently, successful completion of this course is also required for consultant prequalification in Construction Inspection and Quality Assurance Testing categories.

Department personnel are required to complete the STTP S-34 training course in order to operate a portable nuclear gauge as discussed in Section 900 of the IDOT [Project Procedures Guide](#) (PPG).

Successful completion of STTP S-19 and S-32 is not mandatory, but it is highly encouraged for field personnel that will be involved in the construction inspection of pile or drilled shaft foundations.

Training manuals and contact information for some of the above STTP courses are available at:

- **Soils/Geotechnical page:** Under the "Training" tab located near the middle of the page at [Home > Doing Business > Material Approvals > Soils](#).
- **Foundations & Geotechnical listings:** at [Home > Doing Business > Procurements > Engineering, Architectural & Professional Services > Consultant Resources](#). On this page, select the "Bridges & Structures" tab located near the middle of the page, and then the information is listed under the "Foundations & Geotechnical" drop-down button located about half-way down the "Specific Scope of Services" list.

8.3 Embankment Construction

The exercise of control over embankment construction is a necessity recognized by all road building agencies. It is essential that the RE and the embankment inspectors thoroughly understand the importance of ground preparation, compaction and stability, to assure that construction is in compliance with the [Standard Specifications](#).

Present day embankment construction proceeds more rapidly than in the past. In many cases, pavements are placed upon embankments that are completed during the same construction season. It is necessary that accurate and timely density determinations be made, as

Geotechnical Manual

Chapter 8 Geotechnical Construction Inspection

construction proceeds, to ensure that the specified density is obtained. Tests should be made in a manner to interfere as little as possible with the construction progress. The minimum number of density tests required is stipulated in the current IDOT PPG. However, if specification compliance is obtained with the minimum required testing, extra check tests are often necessary. Close observation of a contractor's work, and the performance of equipment on the grade is just as important as testing. The RE and the embankment inspectors must read and thoroughly understand the documents listed in [Section 8.1](#).

Though it is not the intent of this manual to quote from the [Standard Specifications](#), the following comments are considered particularly relevant: "When embankments are to be constructed on hillsides or slopes, or existing embankments are to be widened or included in new embankments, the existing slopes shall be plowed deeply. If additional precautions for binding the fill materials together are justified, steps shall be cut into the existing slopes before the construction of the embankment is started." (Article 205.03.)

Generally, a contractor should have little difficulty in obtaining satisfactory densities. Should the field moisture be considerably below OMC, it may be impossible to satisfy density requirements without the addition of water. Conversely, if the soil is considerably wet of optimum, it may also be impossible to obtain the required density without processing and aeration, or the use of a drying agent such as lime.

Compaction to the specified density is intended to accomplish two purposes. First, it provides the shear strength necessary to resist failure under the applied stresses. Second, adequate density packs the soil grains in such close contact that embankment consolidation settlement is minimized. Embankment settlement will occur because of its own mass (weight), or because of structural loading.

Cohesive soils and fine grained silty soils are often troublesome. On the dry side of optimum, cohesive soils can display excellent shear strength during construction. If left below target density, these soils will become much weaker upon saturation, at some later time. Soils compacted on the wet side of optimum may achieve target density, but the shear strength will be less than that at optimum.

Geotechnical Manual

Chapter 8 Geotechnical Construction Inspection

If the moisture content is too high, and compaction efforts are continued without aeration and moisture reduction; the flake shaped clay particles tend to orient themselves parallel to each other, rather than in a random single grain relationship. While this orientation may result in some slight density increase, it also results in a reduction in the soil shear strength. Thus, a soil with moisture content considerably wet of optimum should be dried back, prior to compaction.

Silty soils of very low plasticity, for all practical purposes, develop no cohesive bond between the grains. They achieve their load carrying ability from their angle of internal friction, and the contact pressure between the soil grains. These soils are particularly sensitive to excess soil moisture. When silty soils are compacted wet of optimum, without adequate aeration, they may become “pumpy” to the point that the grade is completely unstable.

Regular inspection of the embankment should include: 1) detection of bulging side slopes; 2) cracks at the top or on the sides of the slopes; 3) heaves at the toe of slope; and 4) any movement adjacent to structures, or distress within the same. Evidence of movement or incipient failure should be reported to the DGE.

Special precautions should be taken with embankments in excess of 10 ft. in height. Different soil types should be blended. Since haul roads cut into the side of embankments are frequent sources of subsequent sliding, haul roads should ideally be constructed outside the confines of the embankment. Good compaction is essential on the embankment slopes. This can best be accomplished by building the slopes slightly wider, and then trimming to the cross section template.

8.4 Borrow and Excavation Materials

As per the [Standard Specifications](#), “Neither borrow nor furnished excavation shall be placed in the embankment until the site location, excavation plan, and material have been approved by the Engineer in writing.” The material must be tested and approved by the DGE. The location must be bored or excavated with a backhoe (or other approved method) to collect samples of the soil horizons for testing. This should be done at least 2 weeks prior to the placement of any material, to allow time for the appropriate tests to be conducted on the soil horizons encountered.

Geotechnical Manual

Chapter 8 Geotechnical Construction Inspection

The proposed borrow material to be used in the top 24 in. of subgrade should meet the permissible limits in [Table 8.4-1](#). Materials that do not meet the permissible limits in [Table 8.4-1](#) should be confined to the embankment core, encompassed by a 24 in. cover material, which meets the testing requirements.

Any new soil encountered in the borrow pit during construction (that has not previously been tested) must be subjected to the tests in [Table 8.4-1](#), and meet the permissible limits in the Table.

Excavation materials result from roadway excavation (cut sections), ditch and channel change excavation, excavation for structure foundations, and excavations for utility installations. All of these materials may be suitable for use in embankment construction.

Available soils should be collected for the required testing ([Table 8.4-1](#)) during the geotechnical exploration. The results should be included in the Geotechnical Report for embankment construction use. Every effort should be made to have all tests completed, for the major soil types expected to be used in embankment and subgrade construction, before construction begins. The borrow soil proposed for the top 24 in. subgrade should be tested for IBV and/or IBR, depending on the design objectives. For materials to be placed within the embankment core, 24 in. below the subgrade surface, the material shall: 1) have 90 pcf minimum SDD; 2) not have more than 10% organic content; and 3) if a coal combustion by-product (CCB) is proposed as a borrow material, it shall not contain more than 5% SO₃.

If CCB is proposed as a borrow material, the DGE must be familiar with Section 3.94 of the January 1996, Environmental Protection Act, regarding the rules and conditions of using CCB beneficially. A copy of Section 3.94 of the Act may be obtained from the CBM's Geotechnical Engineer; or from the Bureau of Land, Illinois Environmental Protection Agency. Also, a minimum 2 ft. of earth must cap the CCB, according to the [Standard Specifications](#). This will provide better erosion protection than the 1 ft. of cover required by the Environmental Protection Act, and it will provide better support for the growth of vegetation.

If reclaimed asphalt pavement (RAP) is proposed as borrow, it must not contain expansive aggregate (such as zinc or steel slag), to avoid problems with swelling. A minimum 2 ft. of earth must cap the RAP, according to the [Standard Specifications](#).

Geotechnical Manual
Chapter 8 Geotechnical Construction Inspection

REQUIRED TEST	AASHTO METHOD	PERMISSIBLE LIMIT
SDD (at OMC)	IL Mod. T 99 (Method C)	90 pcf min. *
Organic Content	T 194	10% max.
Percent Silt and Fine Sand	T 88	65% max. **
PI	T 90	12% min. **
LL	T 89	50% max.
Shear Strength (c) at 95% SDD	T 208 or T 234	1,000 psf min. ***
SO ₃ ****	ASTM C 618	5% max.
* As per Standard Specifications . ** Frost susceptibility criteria. *** For engineered embankments which are 15 ft. in height or greater. **** Only for CCB.		

Table 8.4-1 Requirements of Borrow and Furnished Excavation Soils for the Top 24 in. Subgrade.

8.5 Compaction and Density Testing

All density tests must meet the minimum specification requirements. If a test does not meet the requirements, additional work must be done. No additional earth placement should be permitted until the failed area is retested and approved by the Engineer.

As per the [Standard Specifications](#), "The dry density of the compacted embankment will be determined by the Engineer at regular intervals according to AASHTO T 191, Illinois Modified AASHTO T 310 (Direct Transmission Density/Backscatter Moisture), or by other methods approved by the Engineer." It is not the intent of this chapter, to detail the specific methods of density testing (See [Chapter 4](#)). The embankment inspector or the RE should be trained to properly conduct the field density test.

The embankment inspector should constantly bear in mind that soils do vary from point to point, even in areas where they appear to be rather geologically uniform. Therefore, she/he must

Geotechnical Manual

Chapter 8 Geotechnical Construction Inspection

observe changes in the material used in the embankment, to properly select the moisture-density control curve for use in computing the percent of compaction.

One of the difficult tasks for an embankment inspector is to identify the soil being tested for density and select the correct moisture-density control curve. One of the more accurate methods is to collect a sample of the soil from the location being tested and run a one-point Proctor test (Illinois Modified AASHTO T 272), as described in [Section 4.7.1.1](#).

8.6 Placement of Backfill

The manner of embankment construction adjacent to structures is important. Even the casual observer cannot help but notice that the settlement of pavement placed on backfills over culverts, or adjacent to bridges and retaining walls is one of the most frequent defects to occur in highway construction. The settlement, generally, occurs long after the final payment has been made on the contract.

It is unfortunate that the problem of working in a confined space should occur, where the need for a good fill is greatest. The cramped working space, the relatively small volume of fill involved, and the backfill material locally available are contributing factors for improper backfilling. It is the purpose of this section to demonstrate the importance of the backfill, to point out the reasons for specified backfilling procedures, and to show some construction practices that should be avoided.

8.6.1 Importance of Backfill Characteristics

8.6.1.1 Strength and Compressibility

In order to reduce pressures against the wall, a granular backfill should be dense, and a cohesive backfill should be very stiff. Otherwise, in addition to excessive wall pressures, it will settle after it is placed. A low compressibility backfill is as important as a high shear strength backfill. Fortunately, high shear strength and low compressibility usually go hand in hand. If nothing of importance is to be constructed above the retaining wall, perhaps the settlement will not be important. If the backfill is to support a railroad track, a highway, or a building, settlement will be undesirable. The frequent bump in a concrete highway as the pavement reaches the bridge develops because the pavement has settled. In most cases, such settlement is attributed to the

Geotechnical Manual

Chapter 8 Geotechnical Construction Inspection

improper compaction of the backfill, or because the soil under the embankment was soft and compressible.

Settlement behind bridge abutments has become so common that the designers of highway bridges frequently include an approach slab; which is a heavily reinforced slab resting partly on the abutment, and partly on the approach fill. The slab is supposed to bridge over the space left under the slab, by settlement of the backfill. Many times, the soil under the entire approach slab has settled; and the bump is still there, although it is spread over a greater length.

8.6.1.2 Drainage and Selection of Materials

A retaining wall or an abutment is not designed as a dam; otherwise, it would be much stronger and more expensive. A common design practice equates the lateral push of the soil against the retaining wall to a hydraulic fluid, described as equivalent fluid pressure, which translates into an ***equivalent earth unit weight***. The equivalent earth unit weight depends upon wall height, type of backfill, and steepness of retained slope. This unit weight ranges from 35 to 60 pcf.

To avoid excess pore water pressure behind the wall, the backfill should be a material that can be drained, and a drain should be provided to allow unbalanced fluid pressures to dissipate. The best backfill materials are broken stone, gravel, and sand. These materials are best, not only because of their drainability, but also because of their high angle of internal friction, which contributes to their shear strength. These materials are more easily placed and compacted than the fine grained soils and have low compressibility, if properly placed. Silty or "dirty" sand is less desirable because of the reduced permeability, the increased difficulty in obtaining compaction, and a lower shear strength associated with a lower angle of internal friction. With fine grained cohesive or silty soils, increased care in placement is a necessity to obtain density; otherwise, excessive forces can be exerted on the wall. Drainability of cohesive backfill materials is difficult, if not impossible, and requires the inclusion of special drainage features behind the wall.

A cohesive backfill is least desirable, not only due to problems with drainage, but also due to volume changes caused by cyclic wetting and drying with time. Compaction of these materials in a confined area is difficult. Inadequate compaction results in excessive settlements and wall distress.

Geotechnical Manual

Chapter 8 Geotechnical Construction Inspection

8.6.2 Construction Problems and Effective Inspection

A successful contract requires the combined efforts of a competent contractor and good inspector. Even the best of contracts will encounter opportunities to develop problem situations, in the absence of attention to details.

The [Standard Specifications](#) require the embankment and backfill materials be compacted in layers, not to exceed 8 in. thickness when in loose condition. Uniform distribution of the layer is not easily accomplished, and in the absence of good distribution, mounds up to 24 in. may inadvertently be included. Inadequate compaction of such thick spots is inevitable and can result in a spongy embankment.

An area very sensitive to construction problems is the backfill adjacent to corrugated metal pipe culverts. These are multiplate structures that derive their stability from the backfill on both sides. The good performance of a multiplate structure requires uniform backfill placement on both sides of the structure, and proper compaction. Operation of heavy equipment too close to the sides and above the springline (line of maximum horizontal thrust) can deflect the multiplate structure; causing a reversed arching action which could result in distress or failure. Culverts are prone to have an accumulation of soft, saturated soil adjacent to the base of the walls. If the accumulated volume of these soft materials is sufficient and is not cleaned out, its semi-liquid consistency will result in high equivalent earth mass (weight) pressures at the base of the wall.

Backfill under the haunches of pipes, alongside of culverts, and in back of retaining structures will frequently require the use of hand tamping equipment. The use of large equipment is understandably desired by contractors and will be employed wherever possible for economic reasons. In sensitive areas adjacent to structures, hand operated compactors (though much lower in productive capacity) are better suited to perform the necessary compaction, without overstressing the structure walls. Similarly, cold weather construction may obscure the true character of soft soil along the base of wall, due to its frozen state. The inclusion of frozen soil in backfilling may, at the time of placement, appear entirely stable and very satisfactory. However, the spring thaw may cause structural distress and settlement of the adjacent embankment. For this reason, the [Standard Specifications](#) do not allow the use of frozen soil as a backfill.

Geotechnical Manual

Chapter 8 Geotechnical Construction Inspection

The inspector must remember that close inspection compliance with the [Standard Specifications](#), and insistence upon acceptable materials are essential for backfill operations.

8.7 Subgrade Construction and Subgrade Stability

Subgrades could be at the top of an embankment section, at the existing ground surface, or at the bottom of a cut section. The subgrade at the top of an embankment section should be at a favorable moisture and density, since both have been controlled during the embankment construction. Conversely, the subgrade at or below the existing ground surface is greatly affected by the *in situ* soil conditions.

An exposed cut should be examined, as soon as possible, after it has been opened up. This is especially important in order to determine whether conditions are essentially similar to those predicted in the Geotechnical Report. The most thorough soil survey gives specific information only at point locations. Careful examination of the excavation is helpful in delineating unsatisfactory foundation or drainage conditions that will require correction. Of special importance are the presence of any weak foundation materials (those that are weaker than originally anticipated) and materials that differ significantly from the adjacent material, with respect to frost susceptibility. If the inspection reveals excessive seepage into the cut, it is almost certain that problems of instability (often including frost action) will result in a rapidly deteriorating pavement and/or slopes, unless special corrective measures are taken.

The stability of an earth subgrade is of particular importance for the construction and performance of the proposed pavement structure. The Engineer should make a careful inspection and evaluation of the entire subgrade for stability, prior to placement of the pavement structure.

The stability of the subgrade can be easily evaluated by observing the amount of deflection, and/or rutting taking place under the wheels of heavy construction equipment. Areas of low support or soft spots should be tested, with either a SCP or DCP to depths typically ranging from 18 in. to 30 in., and the results evaluated according to IDOT's [SSM](#), to determine the necessary depth of corrective action.

The [SSM](#) provides the requirements for subgrade stability. An analysis of equipment sinkage and soil compaction operations has indicated that a minimum IBV of 6% is required, to limit

Geotechnical Manual

Chapter 8 Geotechnical Construction Inspection

rutting depth to 1/2 in. (12.5 mm). If the IBV is less than 6%, remedial measures are necessary. If the IBV is 6% to 8%, subgrade treatment is optional; and if the IBV is greater than 8%, no treatment is required. The DCP or the SCP described in [Sections 4.7.2.1](#) and [4.7.2.2](#), respectively, are used to determine the thickness of subgrade treatment. The DCP's PR is converted into an IBV, by using the IBV vs. PR correlation in [Figure 8.7-1](#).

This figure is based on the South African Charts (Mauer and deBeer, 1988). The IBV is then entered into [Figure 8.7-2](#) to determine the thickness of subgrade treatment, if needed. For the SCP, the cone index is entered into [Figure 8.7-2](#) to determine the thickness of subgrade treatment.

The remedial procedures are discussed in [Sections 6.3.3](#) and [6.4](#). Also, refer to the [SSM](#).

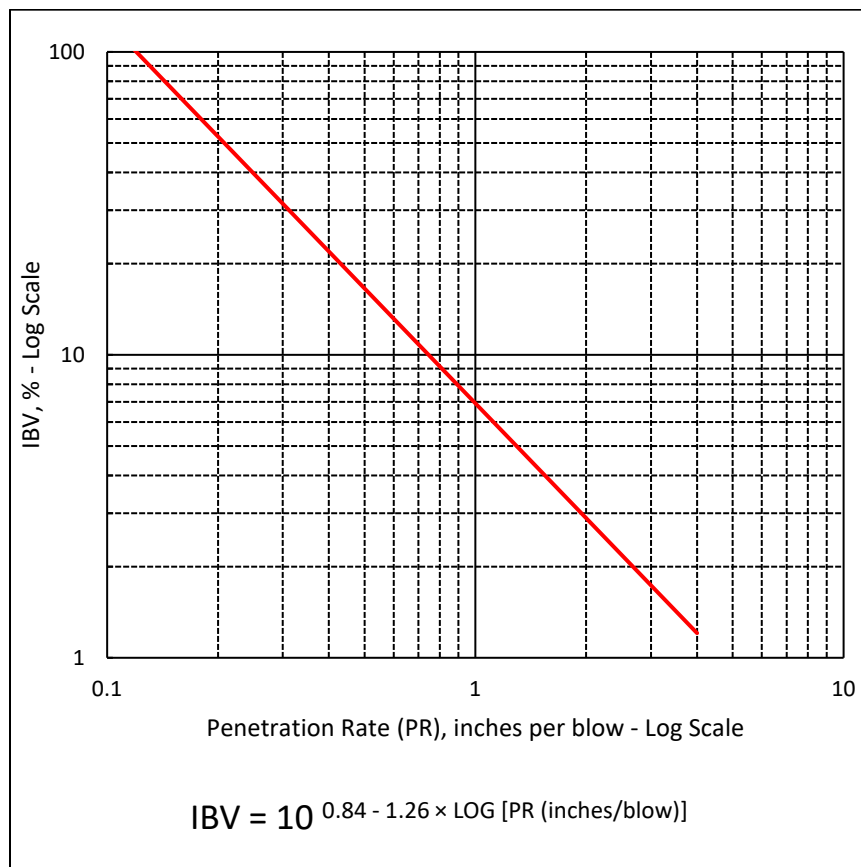

Figure 8.7-1 DCP's PR Values vs. IBV in English Units

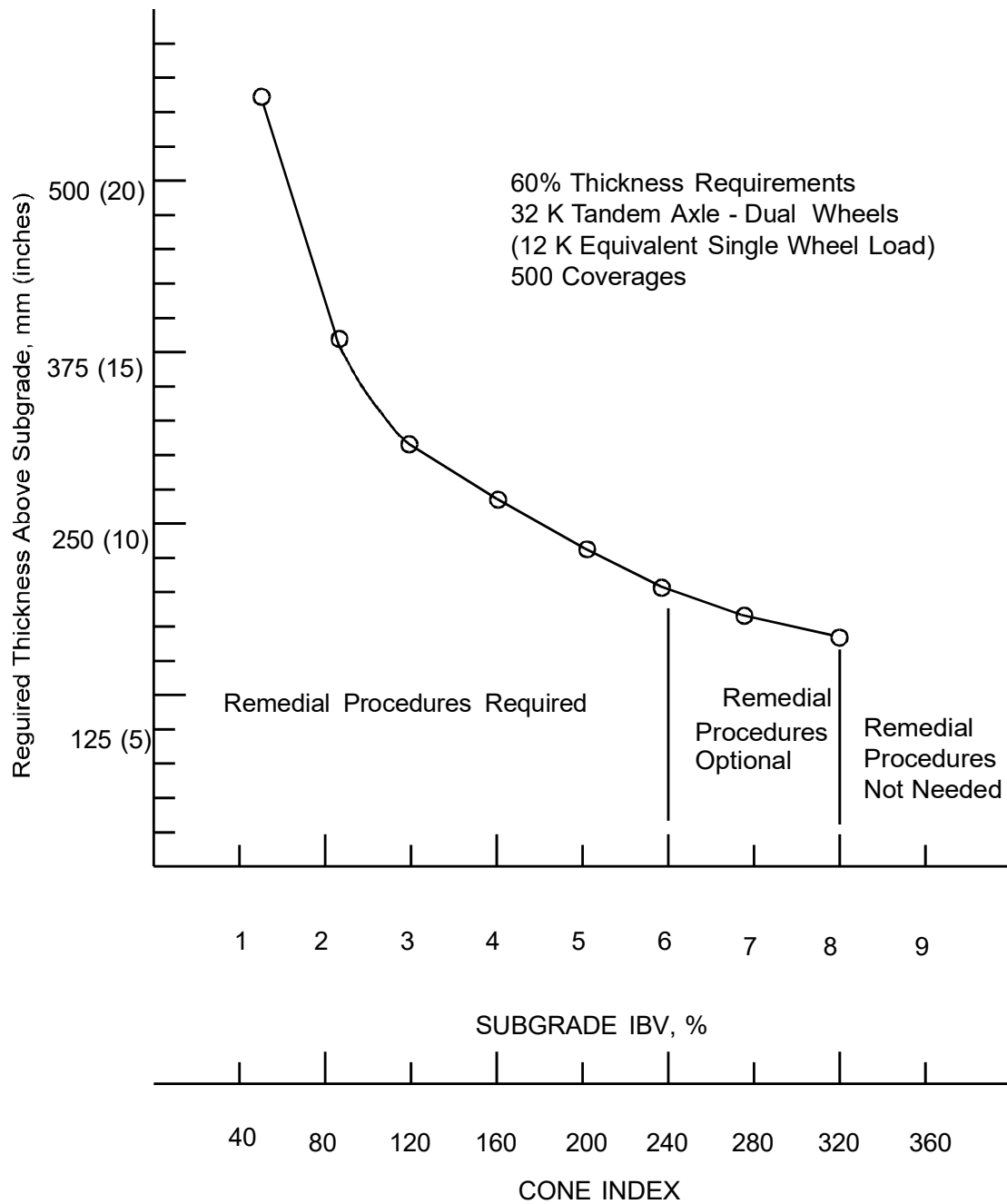

Figure 8.7-2 Thickness design as a function of IBV for granular backfill and lime modified soil remedial action (from [SSM](#))

Geotechnical Manual

Chapter 8 Geotechnical Construction Inspection

If deep undercut or excavation is necessary to remove a peat bog, several removal and replacement methods are discussed in [Section 6.4.4.2](#). In some cases, when the excavation must be carried out under water, it is essential to probe the bottom of the excavation continually, to determine if all organic material has been removed. Probing can be accomplished on a boat or raft. In dry excavation, the bottom of the trench can be directly inspected. In all cases, inspection should be made to ensure that all organic material has been removed, before the backfill is placed.

Sometimes, it is difficult to determine precisely where the boundary of stable mineral matter exists, since marl is often found beneath the organic peat. This material, when disturbed, frequently has the appearance of being extremely soft and unstable. This condition is especially notable when the material has been disturbed during the excavating process. In the undisturbed condition, however, it might be quite satisfactory as a foundation material for the backfill. The field engineer must exercise considerable judgment, to avoid over excavation which will increase construction costs.

Chemical treatment consists of either modification or stabilization, by treating the soil with hydrated lime, lime by-products, lime slurry, fly ash, Portland cement, or Portland blast-furnace slag cement, as discussed in [Section 6.3.3.2](#). The specific details for soil modification and stabilization are in the [Standard Specifications](#).

Equipment requirements for soil modification or stabilization construction are nominal. Normally, the lime or other chemical modifier can be spread by the bulk delivery tanker. If the soil is very wet, special techniques such as a dozer towed trailer dolly or a high flotation tired, spreader truck may be needed. Although rotary mixers (tillers) are desirable, disking has been satisfactorily used for lime or other chemical modification construction. Conventional compaction equipment is used in all soil modification or stabilization construction.

Lime or other chemically treated soil layers up to 14 in. in thickness have been constructed in one lift on some projects in Illinois. Conventional rotary mixers can readily handle lifts up to approximately 12 in. However, special procedures and/or deep plowing may be needed to construct thicker layers.

Geotechnical Manual

Chapter 8 Geotechnical Construction Inspection

Control of the compaction moisture and density is another alternative for improving the subgrade. However, this alternative has not been recognized as part of the 12 in. “Improved Subgrade” required in the MPD policy. Since the purpose of the “Improved Subgrade” is to provide a stable platform under construction equipment, controlling the subgrade moisture could significantly increase its IBV (to at least 6%) and provide the required stability. This option of moisture control could result in significant cost savings on many projects. Project specific soil conditions should be evaluated by the DGE to determine what treatment, if any, is needed to provide a stable working platform.

The decision for the type of improvement of the upper 12 in. of the subgrade is not always readily apparent and will depend upon; whether the area is urban or rural, the soil reactivity with lime, the size of the area to be improved, and overall economics. Because of the several choices for corrective treatment, District Materials and Design personnel should be notified.

8.8 Shallow Foundation / Spread Footing Inspection

The use of spread footings is a design option available to the structural designer, when the boring data indicates the presence of foundation material of such density or strength that no deep foundation treatment is necessary.

When the excavation for a spread footing is made to the design footing elevation, the DGE should be at the site to inspect the excavation, and establish by testing, as necessary, proof that the foundation materials are satisfactory. In general, the Q_U of the *in situ* foundation material, at the design footing elevation, should be determined and checked against the design value. A DCP is normally acceptable to check the *in situ* Q_U .

Situations arise, from time to time, when the foundation boring does not adequately describe foundation conditions. For example, if the foundation material is bedrock, it may be encountered above or below the planned footing elevation; or it may be sloped or stepped in a manner that the plans could even require modification to fit the field conditions. When the foundation material is soil, it may prove weaker than anticipated, or perhaps, the competent layer is deeper than the foundation borings indicated. If the excavation requires deepening, proceed with caution, removing only as much material as necessary to satisfy design requirements. If the excavation must be deepened more than 24 in., the BBS should be advised, since design modifications may

Geotechnical Manual

Chapter 8 Geotechnical Construction Inspection

be required. The excavated, weak material should be replaced by a coarse, clean, crushed stone or gravel.

If the elevation of the footings is below the groundwater elevation, water may seep into the excavation. The water will seep from the sides and bottom of the excavation. Water should not be permitted to pond on the foundation soil. Depending on the nature of the materials, seepage water may be collected in sumps and pumped out. Under less common conditions, water may be drawn down by the use of a well point system. Once the excavation has been advanced (as required) to expose competent foundation material, it is desirable to proceed immediately with the footing construction. Delays in doing so could result in softening of the foundation material by moisture changes or ponded water. This commonly occurs with clayey shale. Ponded water would also require further dewatering measures. If faced with unanticipated delays, the pouring of a ± 6 in. thin concrete seal coat over the footing material is recommended. This alternative is a protection measure against further exposure and deterioration.

8.9 Foundation Preparation for Box Culverts

The foundation soil requirements for a culvert barrel vary depending on the size of the culvert, the fill height above the culvert, the current foundation soil loading, and whether the culvert is pre-cast or cast-in-place. Foundation soils supporting culvert wing walls on spread footings have specific strength requirements based on the applied loadings.

During the design of box culverts, subsurface boring data is obtained and included in the plans. The designer will indicate on the plans any removal and replacement required to address settlement. The plan area and depth of removal should correspond to the boring data so that the inspector can determine the material the designer wants removed and what can remain. Since the conditions encountered upon excavation can differ, the District Geotechnical Engineer and Field Construction Engineer may need to extend or reduce the limits to address the “as encountered conditions”. Unless otherwise noted, the limits and depth of removal and replacement should not be significantly altered by the inspector without consulting with the District Geotechnical Engineer. If there are differing or difficult subsurface conditions regarding undercutting at culverts, contact the District Geotechnical Engineer.

Geotechnical Manual
Chapter 8 Geotechnical Construction Inspection

When no removal is indicated in the plans, a contractor may need a so-called “working platform” to properly construct the culvert bottom slab when the foundation soils become unable to support equipment and laborers during excavation, rebar placement, forming and concrete placement. The need for such platforms is dependent on the type, thickness and strength of the soils encountered, the method of water diversion selected by a contractor, precipitation, construction sequence and the time of the year the box is constructed, and thus, such platforms generally are not shown on the plans. The inspector should contact the District Geotechnical Engineer to determine if field conditions necessitate a working platform. General guidelines for working platforms based on DCP data are shown in [Table 8.9-1](#). Soil should be tested to a depth 3 feet below the bottom of the culvert.

DCP Rate (in./blow)	IBV	Q_u (tsf)	Working Platform Thickness Guideline
< 4.6	< 1	< 0.3	Contact District Geotechnical Engineer
4.6 to 3.3	1 to 1.5	0.3 to 0.5	2 ft.
3.3 to 2.6	1.5 to 2	0.5 to 0.7	1 ft.
2.6 to 2.0	2 to 3	0.7 to 1.0	0.0 to 0.5 ft.
> 2.0	> 3	> 1.0	0.0 ft.*
* Note: Bedding is required beneath pre-cast culverts even if the recommended undercut is zero according to Article 540.06 of the Standard Specifications .			

Table 8.9-1 Guideline for Working Platforms at Culverts

The recommended working platform thickness represents the total depth of replacement material beneath the box. This includes the bedding material required beneath pre-cast box culverts according to Article 540.06 of the [Standard Specifications](#). (Note that bedding is required beneath pre-cast culverts even if the recommended undercut is zero.)

Unsuitable materials are generally replaced with aggregate when soil strength and groundwater conditions dictate. A special provision for Aggregate Subgrade Improvement or Rockfill should be included in the plans to indicate the replacement material properties and capping requirements. If there is no special provision in the contract documents, the selected gradation of aggregate should be as directed by the District Geotechnical Engineer.

Geotechnical Manual

Chapter 8 Geotechnical Construction Inspection

8.10 Pile Foundation Construction Inspection

There are a number of pile types with varying sizes, shapes, and materials to suit a site's special requirements and project economic considerations. Although timber piles and precast piles are occasionally specified, the most common pile types utilized by the Department are metal shell and steel H-piles.

For driven piles, the primary geotechnical concerns during construction are ensuring that they achieve the nominal required bearing and obtaining adequate embedment to carry lateral loads. The following sub-sections provide background information and additional guidance for pile driving inspection.

Although the majority of piles are installed by driving, there are some cases where piles are set in rock. [Section 8.10.8](#) discusses construction inspection for setting piles into rock.

The [Construction Manual](#) and the [Standard Specifications](#) contain the necessary information for inspecting and verifying that a pile installation satisfies the design requirements. Pile design issues are briefly discussed in [Section 6.13.2](#) and its sub-sections.

8.10.1 Interpretation of Boring Logs

Before beginning pile driving, the inspector should review the boring logs and SGR in order to develop a reasonable understanding of the physical characteristics of underlying strata which the pile will be driven into. The RE, inspector or the DGE can use this information to anticipate how the piles may behave during the driving operation and help identify when potential problems may be occurring during driving.

The inspector should consider the proximity and consistency between the various borings near the pile driving operation. In some cases, access to the proposed substructure site during the subsurface investigation may not be possible, requiring the SGR author to estimate the pile lengths using their best judgement and the adjacent borings. Often times, the estimated pile lengths at these locations may not be as accurate as those with closer boring data. In addition, variability between adjacent borings further decreases the accuracy of the estimated lengths. In

Geotechnical Manual

Chapter 8 Geotechnical Construction Inspection

either case, it is recommended that the inspector look for these conditions and be mindful of them when determining the production pile order length and during driving.

It is important for the RE or inspector to understand the information contained in boring logs in order to be able to anticipate how a pile will behave during driving. If the inspector has questions about the information shown on the log, [Section\(s\) 4.4.7.1.2](#) and [4.4.7.1.3](#) can be referred to and contact the DGE for further guidance. Some soil conditions will be indicators of easy driving conditions, hard driving layers or refusal bearing material. [Table 8.10.1-1](#) may be used to predict hard or easy driving conditions for displacement piles (e.g. metal shell, timber, and precast concrete). Also, [Section 6.13.2.3](#) and its sub-sections can be reviewed for information on the calculation procedure for estimating pile lengths.

SOIL TYPE	HARD DRIVING	EASY DRIVING
Granular	$N > 30$	$N < 10$
Cohesive	$Q_u > 4 \text{ tsf}$	$Q_u < 1 \text{ tsf}$

Table 8.10.1-1 Driving Conditions for Displacement Piles

Non-displacement piles (such as steel H-piles) are **not** addressed in [Table 8.10.1-1](#) because H-piles drive much easier than do displacement piles in similar soil situations. This is primarily due to the much smaller cross-sectional area at the end of the pile and the lack of soil displacement which creates lower friction and adhesion along the length of the pile.

Other items to look for on boring logs include:

- Soil layers which indicate high blow counts or high Q_u values
- Potential obstructions such as cobbles, boulders or buried pavement
- Soft or loose layers and organics
- Groundwater elevation
- Bedrock type and elevation

For additional assistance with evaluating the boring data or if there are any questions pertaining to specific information contained on the logs, contact the DGE.

Geotechnical Manual

Chapter 8 Geotechnical Construction Inspection

8.10.2 Drive System Acceptability

The Department uses the Washington State Department of Transportation (WSDOT) pile driving formula ([Section 8.10.6.1](#)) to estimate the capacity of a pile during driving. The WSDOT dynamic formula provides a relatively accurate prediction of pile capacity when a pile is driven at rates falling within 1 to 10 blows per inch. Piles driven outside this range either over predict pile capacity or provide excessively conservative results. The [Standard Specifications](#) provides formulas for the maximum and minimum hammer energy the contractor can use to drive a pile of a specified capacity in order that the piles will drive between the 1 to 10 blows per inch rates. Pile hammers not meeting the minimum energy (10 blows per inch rate) requirement cause pile capacities to be under predicted and driven unnecessarily long. Conversely, piles driven with hammers which exceed the maximum permissible energy result in pile penetration rates of less than 1 blow per inch run the risk over predicting pile capacity and potentially creating unsafe conditions. Excessively large hammers also increase the risk of damaging the pile during driving. The "WSDOT Pile Bearing Verification" spreadsheet, available on the IDOT website ([Section 6.19](#)), can be used by the inspector(s) to calculate the maximum and minimum hammer sizes to determine the acceptability of the contractor's proposed hammer.

Prior to beginning pile driving, contractors are required to provide the RE with information about the hammer they propose to use. This information is needed to verify that the hammer meets the energy requirements specified in Article 512.10 of the [Standard Specifications](#). The Department form [BBS 136](#) (titled Pile Driving Equipment Data) was developed for use when WEAP or CAPWAP[®] analysis is required and can be used by contractors to submit hammer information to the RE. In addition to information on the hammer, the contractor shall also provide the crane size (boom length), type of leads (swinging or fixed), the overall length of the leads, as well as the number of planned splices the contractor included in the bid.

It is also important that the combination of the proposed pile, soil, and hammer system be selected so that it results in acceptable driving stresses. In the past, IDOT has largely relied upon empirical maximum nominal required bearing values believed to generally result in acceptable driving stresses. Research has shown that IDOT can increase the maximum nominal bearing that some piles can be driven. However, taking a closer look at the resulting driving stresses becomes necessary. The Simplified Stress Formula (SSF) presented in the research report by [Long and](#)

Geotechnical Manual

Chapter 8 Geotechnical Construction Inspection

[Anderson \(2014\)](#) was developed for this purpose and appears to provide a relatively good estimate of the driving stresses.

Driving stresses may also be evaluated by conducting a wave equation analysis of pile driving (WEAP) with the WEAP software or the RE may request that the PDA be used ([Section 8.10.7.1](#)) to monitor stresses during driving. In either case, driving stresses should not exceed 90% of the yield stress of a steel pile. If there appears to be cause for concern, the BBS may be contacted for assistance.

8.10.3 Precoring at Pile Locations

The substructures to be precored as well as the diameter and depth of the precore hole should be specified on the plans. Precoring pile locations may be specified on the plans for a number of reasons. When hard layers or buried obstructions are believed to exist at relatively shallow depths, the plans may require a contractor to precore the pile locations in order to allow a pile to be driven past these obstacles without damage. Another reason to specify precoring is to reduce or mitigate downdrag forces on a pile when more than 0.4 inches of settlement is expected to occur in the adjacent soils. The last instance when the plans may require precoring is at integral abutments in order to allow piles to move laterally due to thermal expansion/contraction without causing overstress in the pile.

The diameter specified may be equal to or larger than the pile diameter in the case of metal shells. When the hole is equal in size to a metal shell pile, it allows the pile to develop some skin friction and avoids gaps that would need to be filled. Precoring a larger diameter (oversized) hole causes a pile to drive longer, and the void needs to be backfilled in order to maintain the lateral load capacity. In the case of precored H-piles, the voids will always require backfill regardless of the hole diameter size.

The material used to backfill the voids between a pile and the adjacent soil varies depending on the application. For all applications except integral abutments, loose, dry sand is used for backfilling the precored holes. In some cases, the hole diameter may need to be enlarged over the specified diameter in order to fulfill the design intent. In the case of precoring to address downdrag, the hole should be larger than the metal shell diameter or H-pile diagonal in order to avoid contact with the settling soils. However, in all cases, the diameter of the precore hole needs

Geotechnical Manual

Chapter 8 Geotechnical Construction Inspection

to be large enough to accommodate backfilling with loose, dry sand through the entire depth of the precoring hole.

For precoring specified at integral abutments, oversized holes are specified to accommodate the expected lateral pile movement and must be backfilled with a material which provides limited lateral soil resistance, such as bentonite, which should be placed after pile driving. A project special provision should be included in the contract documents to address the bentonite material specifications and construction requirements. This special provision is available through the BBS.

For additional information on precoring, refer to [Section 6.13.2.3.4.4](#).

8.10.4 Pile Damage

Most of the focus on pile damage in this section pertains to pile driving. However, methods of storage and handling are also important. These methods vary depending on the type of pile. In the case of precast concrete and precast, prestressed concrete piles, proper handling and storage are vital in order to guard against damage. These pile types need to be supported (during shipping, lifting, and stock piling) at close intervals in order to avoid the development of flexure cracking. Handling and storage specifications for the various pile types are provided in Article 512.08 of [Standard Specifications](#).

Pile damage during driving is a relatively rare occurrence, but it does happen on a few projects each year. Metal shell piles are considered to be the most commonly damaged pile type. Unlike H-piles, metal shells can be visually inspected after driving which allows the Department to identify the location and extent of damage. This inspection information can be used to determine the appropriate course of corrective action. H-piles have been known to break at splice locations and tip damage can occur when driven excessively into hard rock. As a pile is driven into bedrock, a compression wave begins to be reflected upwards and combines with the downward compression wave from the hammer resulting in a doubling of the compressive stress at a pile tip. Conversely, when a pile is driven in soil, compression waves traveling downward from the hammer are reflected back as a tension wave. Tension waves are not typically a concern when driving steel piles. However, they can be a concern for precast concrete piles.

Geotechnical Manual

Chapter 8 Geotechnical Construction Inspection

The SGR author is responsible for evaluating the subsurface conditions and only offering the structural engineer the pile type(s), size(s) and capacities in the SGR that will withstand the driving stresses. However, there are variables that are not known with complete certainty; and thus, it is still possible that a pile could be damaged. One variable is that the contractor's provided driving system is unknown in the design phase. Although, the [Standard Specifications](#) limits the maximum hammer energy a contractor can use to drive a pile, driving at a rate near 1 blow per inch can still cause damage in some cases. Another variable is that soil conditions at a substructure may vary from the boring data. Damage may occur from driving a pile into hard layers, boulders, or unknown buried obstructions. Either one or possibly both of these conditions may contribute to pile damage during driving.

Should a pile be damaged during driving, or if there are concerns about damage prior to driving, there are a few strategies available to address the issue which include:

- **Hammer energy:** When driving friction piles with a relatively large hammer, which drives the pile at a rate between 1 to 3 blows per inch, turning down the fuel setting or using a smaller hammer will allow the pile to drive at a slower pace which can lower stress and allow the pile to obtain bearing without damage. For end bearing piles, the pile stress can increase rapidly as the pile enters the end bearing layer. In these cases, it is advisable to turn down the fuel setting prior to reaching the end bearing layer to minimize the risk of damaging the pile.
- **Shoes/Tips:** Although H-pile shoes and metal shell conical tips should be specified in the design phase, they can be added during construction to reduce the risk of pile damage. Pile shoes reinforce the tip to reduce the potential for bending in the pile flanges and the web. Conical tips distribute the end bearing stress into the pile shell more uniformly than a flat bottom plate, allowing the pile to penetrate into hard layers without a sudden overstress. ([Section 6.13.2.3.4.3](#) provides guidance on usage of pile shoes and conical tips.)
- **WEAP Analyses:** The Wave Equation Analysis of Pile Driving (WEAP) program, discussed in [Section 8.10.6.2](#), could be used to model and analyze the dynamic interaction that occurs between a specific hammer driving system, the soil profile, and a pile. The program provides reasonably accurate theoretical estimates of the driving stresses in the

Geotechnical Manual

Chapter 8 Geotechnical Construction Inspection

- pile. If the driving stresses appear to be excessive, WEAP could be used to determine if the hammer may need to be modified or if a different hammer needs to be used.
- **Dynamic Testing:** Pile Driving Analyzer[®] (PDA) equipment can be used to measure the stresses in a pile during driving. Monitoring stresses while driving precast concrete piles can warn an inspector if tension stress levels are approaching that which could damage a pile so that corrective action can be taken (reduce energy, check/replace pile cushion, etc.). When driving end bearing piles, PDA testing can be used to monitor the stress at the tip which is the location most likely to be damaged. ([Section 8.10.7.1](#) provides guidance on dynamic testing.)
 - **Precoring:** When hard layers or buried obstructions are believed to exist at relatively shallow depths, pile locations may be precored in order to allow a pile to penetrate these obstacles. Any voids between the pile and precored hole are typically backfilled with sand unless other backfill material is specified. ([Section 8.10.3](#) provides guidance on precoring.)
 - **Spud pile or spudding:** Spudding is an alternative to precoring. It is when a pile (typically a larger H-pile) is driven and subsequently pulled at the pile location in order to penetrate, break up or push aside an obstruction(s) that would otherwise damage smaller sized production piling. This technique is best suited for locations where the obstruction is relatively shallow due to the difficulty in being able to extract a deeper pile.
 - **Pile type/size:** Changing the pile type or increasing size may allow the same driving system to be used to penetrate the problem soil layers by providing more cross-sectional area of the steel in order to reduce pile driving stress. Typically, changes to the foundation design require contacting the BBS. Depending on the type of change, the BBS may contact the structural engineer of record to determine if the changes are structurally acceptable.
 - **Additional piles:** If the piles have already been ordered and it is economically desirable to utilize them, it may be feasible to add more piles to a substructure which would reduce the required bearing (and driving stresses) so that a pile may be driven without damage.

Geotechnical Manual

Chapter 8 Geotechnical Construction Inspection

However, changes to the foundation design require contacting the BBS, who may involve the structural engineer of record.

When damage does occur, a pile is normally cut off a minimum 6-inches below the bottom of footing or substructure, filled with either sand or lean concrete (in the case of metal shells), and replaced with an additional pile adjacent to it. However, in some cases, a damaged pile may be accepted at a lower capacity. In the event that a pile is damaged, the BBS should be contacted to assist in determining the course of action.

8.10.5 Test Piles

When specified on a project, test piles are utilized to allow the RE to determine the order length of driven production piles at a substructure(s) during construction. On the structure plans, the pile data includes the number of test piles to be driven at each substructure. The RE determines the location of the test pile within a substructure. Typically, it is desirable to position it as far as possible from the boring location in order to assess variability in soil conditions across the substructure.

In order to accurately represent the driving behavior of the production piles, test piles shall utilize the same pile type, size, and drive shoes (or no shoes) as the substructure's production piles. The test piles shall also be driven with the same equipment planned to be used for the production piles. It is important to note the equipment for driving the test pile is to be sized based on the production pile bearing values, and not on the test pile bearing values.

Test piles must be at least 10 ft. longer than the estimated plan length and are driven to 110% of the nominal required bearing value indicated on the plans. This is done to verify that a test pile continues to gain capacity upon further driving after reaching 100% of plan bearing, rather than breaking through a thin layer of higher strength material into lower strength material and losing plan bearing. In addition, test piles driven in production locations must also be driven to a minimum tip elevation when a minimum tip elevation is specified on the structure plans. In cases where no minimum tip elevation is shown, the [*Standard Specifications*](#) require piles to be driven to at least 10 ft. below the bottom of footing or below undisturbed earth, whichever is greater.

Geotechnical Manual

Chapter 8 Geotechnical Construction Inspection

The RE determines the order length of the production piles for a substructure based on review of the test pile record and the foundation boring data. Since unplanned splices take time and are an additional cost, the RE is challenged with ordering adequately long production piles while balancing the cost of ordering extra length against the costs of unplanned splicing.

Prior to driving a test pile, the inspector should be well acquainted with the following:

- Section 512 of the [Standard Specifications](#) (Article 512.15 in particular)
- Construction [Inspector's Checklist](#) for Piling
- [Construction Manual](#)
- [Form BBS 757](#), Test Pile Driving Record
- WSDOT Pile Bearing Verification Spreadsheet ([Section 6.19](#))

Design guidance for selecting the number and locations of test piles for a project is provided in [Section 6.13.2.3.4.1](#), and the inspector can reference the SGR which may contain discussion about the test piles or how the production piles were expected to drive. However, test piles may be added or deleted for individual substructures during construction when site and driving conditions warrant it. In the event that a test pile is suspected of damage during driving, [Section 8.10.4](#) provides guidance on potential courses of action.

The DGE and/or the BBS should be contacted to provide assistance should there be any questions on pile driving or concerns with how a test pile drove (such as sudden changes in pile alignment, suspected pile damage, and erratic changes in pile bearing), determining the order length, etcetera.

8.10.6 Nominal Required Bearing and Pile Length

The estimated length shown on the plans is a rough guess (estimate) of how far the pile might drive in order to obtain the nominal required bearing. Test piles are most often used to determine the ordered pile length delivered to the project ([Section 8.10.5](#)). However, in cases where no test piles are included in the contract, the RE must use the estimated length, the boring data and his/her judgement to determine the length of pile that the contractor needs to provide. In either case, the goal is to order sufficient pile lengths that drive to bearing while avoiding excessively large cutoff lengths and unplanned splices.

Geotechnical Manual

Chapter 8 Geotechnical Construction Inspection

The following sub-sections discuss various methods used by the Department for evaluating the nominal driven bearing of piles, when a minimum driven length (tip elevation) is required, and documentation for production piles.

8.10.6.1 WSDOT Pile Driving Formula

The nominal (or ultimate) driven capacity of piles on most IDOT projects is determined using the Washington State Department of Transportation (WSDOT) pile driving formula. The WSDOT dynamic formula was selected from several formulas that were evaluated in a research study by [Long, et al. \(2009\)](#) and found to be the most reliable amongst those studied. This formula offers convenience in that it is a simple calculation which uses data easily obtained during pile driving and provides the inspector with the nominal driven bearing at any point during driving.

An Excel spreadsheet titled “*WSDOT Pile Bearing Verification*” ([Section 6.19](#)) is available to assist a pile driving inspector to determine the nominal driven bearing at various depths during driving, using the number of hammer blows per inch and the hammer energy. Pile driving can be halted when the RE or inspector is confident that the nominal driven bearing indicated by the WSDOT dynamic formula (as calculated in the spreadsheet) equals or exceeds the nominal required bearing shown on the plans.

Dynamic pile driving formulas, such as the WSDOT formula, are developed in order to predict the driven capacity of friction piles. However, IDOT also uses this formula for piles driven to rock, and the inspector should take care not to overdrive/overstress and damage the pile in hard rock deposits such as limestone and dolomite. This overstress can occur as the pile transitions in an abrupt manor from a relatively low capacity/low stress state (which occurs when driving through soil) at the pile tip to a very high capacity/high stress condition upon encountering the hard rock. For piles driven to softer rock such as shale, the risk for pile damage is much less as the pile driving behavior is closer to driving into a hard soil layer.

When friction piles have been driven to their full furnished length and have not achieved the nominal required bearing at the end of driving (EOD), Article 512.11 of the [Standard Specifications](#) contains provisions for determining the increase in the pile capacity that occurs after the EOD, which is termed "setup" (see [Section 6.13.2.3.4.5](#) for additional information on setup). Waiting for setup is desirable in order to avoid splicing and driving additional pile length when time is

Geotechnical Manual

Chapter 8 Geotechnical Construction Inspection

available. The procedure requires that piles be left for a minimum of 24 hours and redriven an additional 2 inches in order to record the hammer energy and blow count data, which is called beginning-of-redrive (BOR) data. The BOR data is used with the WSDOT dynamic formula to determine the gain in bearing. It should be noted that the BOR bearing calculation must be made within the first 2 inches of pile penetration as the capacity gained from setup is no longer detectable beyond that penetration depth. [Table 8.10.6-1](#) is a reproduction of the table in Article 512.11 of the [Standard Specifications](#), and it provides the RE with a means to determine if the amount of setup required is likely to occur in the time frame available.

Waiting Periods					
Soil Type	24 hours	48 hours	72 hours	96 hours	120 hours
Granular	17%	23%	26%	28%	29%
Mixed	15%	24%	31%	36%	40%
Cohesive	13%	25%	36%	44%	50%

Table 8.10.6-1 Estimated Percent Gain Likely for Nominal Driven Bearing of Piles after EOD

As demonstrated in [Table 8.10.6-1](#), clay soils generally produce higher gains in capacity after waiting for setup, as compared to granular soils. In both cases, the more time that is allowed to pass between the EOD and the BOR, the greater the amount of setup. Piles may be accepted if the nominal driven bearing determined by the redrive (restrike) using the WSDOT formula and BOR data exceeds the nominal required bearing indicated on the plans.

8.10.6.2 WEAP Program Analysis

Although less commonly used, an alternative method of estimating pile capacity involves utilizing the **W**ave **E**quation **A**nalysis of **P**ile Driving (WEAP) program. WEAP can be used to provide the inspector with acceptance criteria consisting of various combinations of blows per inch and corresponding hammer fall height (energy) which indicate that the nominal required bearing has been achieved.

The advantage of the WEAP program is that it models the properties of a specific hammer make and model selected by a contractor and accounts for dynamic interaction of the subsurface soil properties with a pile during driving. This is more detailed than the WSDOT dynamic formula

Geotechnical Manual

Chapter 8 Geotechnical Construction Inspection

which only considers the theoretical hammer energy (using fall height and ram weight) and approximates the soil conditions using the rate of pile penetration (blows per inch). A disadvantage with WEAP is that the program requires personnel with geotechnical expertise and training in use of the software program, which is currently not available at the District level. Advanced planning and coordination would be necessary in order to collect the data and complete the analyses prior to beginning pile driving, which takes substantially more time compared to the use of the WSDOT formula. Contact the FGU or CBM for assistance with the WEAP program analysis.

The [Standard Specifications](#) requires a contractor provide the Department with a WEAP program analysis when a hydraulic hammer is proposed for use. This is because the WSDOT dynamic formula assumes a specific energy loss for diesel and steam/air hammers (represented by the hammer efficiency factors shown in Section 512.14 of the [Standard Specifications](#)) which indicate substantial energy loss (from 45% to 72%) between the theoretically hammer energy and the actual energy delivered to the pile. Hydraulic hammers do not rely on gravity and historically have relatively low energy loss (from 5% to 15%). The WEAP program can more precisely model the specific properties of a particular hammer such as a hydraulic hammer. However, since the nominal required bearing shown on the plans was selected assuming that the WSDOT dynamic formula would be used, use of the WEAP program will require the nominal required bearing to be adjusted. Since the WSDOT formula utilizes a geotechnical resistance factor of 0.55 and Table 10.5.5.2.3-1 of the "AASHTO LRFD Bridge Design Specifications" ([AASHTO, 2020](#)) limits the geotechnical resistance factor to 0.5 if WEAP is used, the nominal required bearing should be increased by a factor of 1.1 (0.55/0.50). As an alternative, dynamic testing with PDA and CAPWAP[®] analysis could be used to either keep the plan's nominal required bearing as is or potentially reduce the nominal required bearing by the ratio of 0.55 divided by the lower resistance factors shown in [Section 6.13.2.3.1.3](#). If a reduction is desired, the BBS shall be contacted to coordinate with the Structural Designer of Record for approval.

Form [BBS 136](#) titled Pile Driving Equipment Data is required to be completed by a contractor when the Department will be performing a WEAP program analysis. This form provides some the necessary program input on the properties of the hammer cushion, helmet, striker plate, anvil, and ram.

Geotechnical Manual

Chapter 8 Geotechnical Construction Inspection

8.10.6.3 Dynamic Testing

Dynamic testing, as discussed in [Section 8.10.7.1](#), may also be conducted to establish the nominal driven capacity. Both the field estimated PDA and CAPWAP[®] predicted pile capacities are more accurate than the WSDOT formula and WEAP analyses. In addition, PDA testing provides driving stress data which may be desirable for some applications.

8.10.6.4 Lateral Capacity and Fixity

Another issue that the Resident Engineer (RE), inspector or DGE should be aware of is when a pile drives substantially shorter than the estimated length. A significantly shorter pile may not have sufficient lateral capacity (pile fixity) anticipated by the structural designer. This is particularly important for piles with relatively short estimated lengths. The RE or inspector should be aware of the design scour depths shown on the plans and make sure that the pile penetration below these elevations is sufficient to satisfy the pile fixity. In some cases, a minimum tip elevation may be specified on the plans in order to avoid this concern. When it is not specified on the plans, the [Standard Specifications](#) requires piles to extend to at least 10 feet below streambed (although in the case of scour, it should be 10 feet below the design scour elevation). If the RE is concerned that there may be a problem, the structural designer of record or BBS should be contacted to determine if the pile embedment is adequate.

8.10.6.5 Documentation for Production Pile Driving

The final driven lengths and bearings are documented on the Production Pile Driving Data form [BBS 2184](#). This information is retained on file and used when future changes to the superstructure loading result in an increase in loading on the existing foundations.

For guidance on documentation of test piles, see Section 8.10.5.

Geotechnical Manual

Chapter 8 Geotechnical Construction Inspection

8.10.7 Dynamic and Static Pile Capacity Testing

Methods of testing pile capacity are categorized by the type of loading used for testing. The dynamic and static loading methods are two main categories used by the Department. Pile capacity testing requires measurement and collection of data to determine capacity. The difference between pile capacity testing and the WSDOT dynamic formula ([Section 8.10.6.1](#)) and WEAP program ([Section 8.10.6.2](#)) is that WSDOT and WEAP only use subsurface soil profile data and basic drive system information instead of actual measured data. As such, dynamic and static pile capacity testing methods are more precise.

The dynamic testing method utilizes Pile Driving Analyzer[®] (PDA) equipment during driving in conjunction with post driving CAPWAP[®] analysis, while the static method involves applying a series of loads to a pile which is referred to as a static load test. Either dynamic and/or static testing methods may be specified depending upon the resistance factor used in the design as discussed [Section 6.13.2.3.1.3](#). These methods are only performed by IDOT when the added expense and additional time required to complete the testing are justified by the potential cost savings or when the level of risk in the substructure design (lack of redundancy, and the like) warrants a higher level of confidence.

The field estimated PDA and CAPWAP[®] predicted pile capacities are considered more accurate than the WSDOT formula and WEAP analyses. However, a static pile load test is regarded as the most accurate method of determining pile capacity.

PDA testing is less invasive than a static load test, it allows testing on a greater number of piles in a quicker amount of time, and it is significantly less expensive. The PDA testing provides information on driving stresses and real-time development of capacity, while CAPWAP[®] refines the PDA data to provide both a better estimate of capacity and pile driving acceptance criteria (minimum blows/in. penetration rate at various hammer energies which indicate adequate bearing).

On large projects, it may be desirable to specify one of or both these more precise methods of determining pile capacity in order to provide a more cost effective foundation. Ultimately, a cost reduction is typically achieved with dynamic and/or static testing by using a larger resistance factor, which shortens the driven pile length and/or reduces the pile size.

Geotechnical Manual

Chapter 8 Geotechnical Construction Inspection

8.10.7.1 Dynamic Testing

The “Standard Test Method for High-Strain Dynamic Testing of Deep Foundations” (ASTM D 4945) outlines the procedure for conducting dynamic testing of piles. This testing involves attaching sensors near the top of a pile to measure the strain and acceleration within a pile due to the hammer impact. The data is collected using a Pile Driving Analyzer[®] (PDA) module which provides estimates of driving stress and ultimate pile capacity in real-time.

The PDA data is used in conjunction with the **C**Ase **P**ile **W**ave **A**nalysis **P**rogram (CAPWAP[®]) to refine the predictions of capacity and driving stress. The CAPWAP[®] uses wave equation methodology to conduct an iterative analysis that modifies the input parameters until the predicted pile acceleration and strain closely match (signal matching) that measured by the PDA in the field.

The PDA can be used to check pile capacity in the field when pile lengths are running excessively long following WSDOT or WEAP acceptance criteria. When re-driving the pile to check for setup, using the PDA can provide additional information on the pile capacity and assist with pile acceptance. When pile damage is suspected, the PDA can be also be used to locate damaged area(s), assess the degree of damage in some cases, and evaluate its impact on pile capacity. In some cases, piles driven with PDA testing may be accepted at capacities lower than those shown on the plans due to the ratio between the resistance factor used in design verses the more favorable resistance factor allowed for the PDA.

PDA testing and CAPWAP[®] analyses are typically specified in the contract documents through a special provision, which requires a contractor to have a qualified testing consultant perform the work. However, when PDA testing is deemed necessary and is not specified in the contract documents, the Department owns PDA testing equipment, and the CBM can be contacted for assistance. All PDA testing and analysis should be coordinated with the BBS.

Geotechnical Manual

Chapter 8 Geotechnical Construction Inspection

8.10.7.2 Static Load Tests

Static load testing consists of applying a series of loads to the top of a pile and monitoring the corresponding movement at the top of the pile for each load increment in order to determine the capacity verses displacement relationship of a pile-soil system. Using this relationship, the ultimate/nominal capacity as well as the expected settlement of the pile can be determined. In some cases, a structure's tolerance for pile settlement may control the pile design service limit capacity that can be used. However, in most cases, an assumed acceptable settlement (Davidson's criteria) is used to determine the ultimate/nominal pile capacity. This test procedure is generally considered to be the most accurate method for predicting pile capacity.

When a static load test is specified in a contract, the test should follow Procedure A for the Quick Test method in ASTM D 1143, "Standard Test Methods for Deep Foundation Elements Under Static Axial Compressive Load" unless another method is specified in the contract.

A static load test begins with driving a pile which is to be load tested. Reaction piles (typically 4) are then driven around the test pile. A reaction frame (typically consisting of a steel beam or pairs of beams) is attached to the reaction piles so that it spans over the pile to be tested. The test pile and reaction piles may be production piles if the reaction frame can be configured to utilize their required plan locations. A hydraulic jack and a load cell are placed between the pile being tested and the reaction frame beam(s). The test pile is instrumented with gages to monitor the deflection at the top of the pile relative to a fixed location that is not affected by the load test. The test begins by applying hydraulic pressure to the jack which pushes against the reaction frame and load cell on top of the pile. The loads are increased in increments of 5% of the nominal bearing shown on the plans. At each increment, the load is held constant for a specified length of time (between 4 and 15 minutes) in order to allow the pile-soil system to adjust to the load and reach a final deflection.

For interpretation of the test results, the load and deflections are plotted on graph along with the theoretical elastic deflection of the pile. The load increment which causes a deflection to exceed the theoretical elastic deflection plus 1/4 inch is typically taken to be the nominal capacity of the pile. The criteria for determining nominal capacity, load increment, holding period, and other information should be provided in a project specific special provision. The BBS can be contacted for an example specification or assistance in case one was not provided in a contract.

Geotechnical Manual

Chapter 8 Geotechnical Construction Inspection

8.10.8 Piles Set in Rock

Piles set in rock are constructed by drilling through the overburden soils and into bedrock a specified distance, placing at least 6-inches of concrete into the excavation, setting an H-pile into the concrete. Then, the rock socket is backfilled with concrete to at least 6-inches above the top of rock, and the remaining portion of the excavation is backfilled with either concrete or porous granular embankment at the choice of the contractor, unless otherwise specified on the plans.

When setting piles into rock is specified on the plans, the diameter and depth of the rock socket shown on the plans is sized to carry both the axial and lateral loads. The contract documents should also contain [GBSP 56](#) which discusses construction and inspection requirements. For additional information on designing piles set into rock, refer to [Sections 6.13.2.3.5](#) and [6.13.2.4.2.2](#).

The initial construction procedures for setting piles into rock are similar to a drilled shaft installation. The inspector needs to make sure the contractor is maintaining the stability of the excavation's sidewall to prevent collapse. Some soil profiles such as stiff clays can be drilled in the dry without concern for collapse, while granular soils and soils below the water table often require temporary casing or slurry for sidewall stability.

The structural designer establishes the rock socket length assuming that the rock type, quality, weathered thickness, and strength encountered in the field will be as indicated on the soil boring / rock core log(s). The inspector must pay close attention to the rock material removed from the socket excavation and compare it to the soil boring / rock core log in order to verify that it is the same type and general quality as described on the log. If the inspector needs assistance with evaluating the rock type and quality, the DGE may be contacted to either provide guidance or on-site assistance. Should the rock appear to be significantly different than the log(s), the DGE and/or BBS should be contacted to do an assessment to determine if the socket length needs to be extended.

The top of rock encountered at each pile location will likely differ from that estimated on the contract plans depending on site variability. Since the socket length must extend into rock a minimum distance below the top of rock, the pile length must be adjusted by cutting or splicing as applicable in order to make sure that the top of pile elevations are as specified on the plans. As

Geotechnical Manual

Chapter 8 Geotechnical Construction Inspection

with drilled shafts, the bottom of the socket must be inspected to verify that it is clear of loose earth, rock, debris and water prior to filling with concrete and setting piles. If it is impractical to dewater due to a high rate of water infiltration or if dewatering would cause hole instability, pumping equipment or tremie methods shall be employed to discharge the concrete at the bottom of the rock socket in order to displace the water or slurry. After a pile is set into the concrete filled rock socket, the pile must be temporarily supported to prevent lateral movement until the concrete has obtained adequate strength. If the portion of the drill hole in soil was not backfilled with concrete, the drill hole should be backfilled with porous granular embankment as soon as possible in order to provide support for the hole's sidewalls.

8.11 Drilled Shaft Foundation Inspection

Verification of geotechnical design parameters during drilled shaft construction is much more subjective than for driven piles or spread footings in that visual inspection and testing is more limited. Given that there is typically no direct measurement of axial resistance during construction, as is the case with driven piling, adequate inspection during construction is essential. The performance and capacity of drilled shafts can be quite sensitive to the subsurface conditions and construction techniques that are used.

Resources available for guidance in drill shaft foundation construction inspection include:

- [Standard Specifications](#)
- FHWA publication number [FHWA-NHI-10-016](#) for “Drilled Shafts: Construction Procedures and LRFD Design Methods” by [Brown et al. \(2010\)](#).
- [S-32 Class Reference Guide](#)
- [Construction Inspector Checklists](#)

As discussed in [Section 8.2](#), the Department offers a training course for drilled shaft inspection, STTP S-32: Drilled Shaft Foundation Construction Inspection. The “[Specific Task Training Program Drilled Shaft Foundation Construction Inspection S-32 Class Reference Guide](#)” (Revised April 2015) for this course may be used as a reference when performing construction inspection of drilled shaft foundations.

Geotechnical Manual

Chapter 8 Geotechnical Construction Inspection

A “Construction Inspector’s Checklist for Drilled Shafts” is also available to aid inspection. If a current version of it is not provided in the [Construction Inspector Checklists](#) section of the IDOT website, then a copy of it may be found in the [S-32 Class Reference Guide](#).

8.11.1 – 8.11.4 (Reserved)

8.11.5 Construction Inspection Documentation

The following forms are available for recording construction inspection tasks for drilled shafts:

- [BBS 133](#): Drilled Shaft Installation Plan
- [BBS 134](#): Drilled Shaft Excavation and Inspection Record
- [BBS 135](#): Drilled Shaft Concrete Placement Log

8.12 Use of Geosynthetics for Roadway Applications

The past three decades have witnessed a rapid growth in the use of geotextiles and geocomposites in transportation engineering. [Section 6.18](#) provides an overview of the different geosynthetic types and applications. Some of the uses to date are as follows:

- Filtration and drainage.
- Sediment erosion control.
- Road material separation.
- Road reinforcement.
- Reinforcement in embankment and retaining wall construction.
- Geocomposite drains behind walls.

As mentioned in [Section 6.18.2](#), some geosynthetics have not been approved for a variety of reasons, including concerns with the long-term strength (creep) and durability. The CBM should be contacted for current practice. A discussion is also included in [Sections 6.3.3.3.4](#) and [6.4.4.9](#).

Geotechnical Manual

Chapter 8 Geotechnical Construction Inspection

The following Sections of the [Standard Specifications](#) (04/01/2016) and special provisions ([GBSP](#)) address construction specifications for various geosynthetic applications:

- Section 210 - Fabric for Ground Stabilization
- Section 251 – Mulch
- Section 253 – Planting Woody Plants
- Section 280 – Temporary Erosion and Sediment Control
- Section 282 - Filter Fabric
- Section 283 - Aggregate Ditch
- Section 284 – Gabions and Slope Mattress
- Section 285 - Fabric Formed Concrete Revetment Mat
- Section 522 - Retaining Walls
- Section 591 - Geocomposite Wall Drain
- Section 601 - Pipe Drains, Underdrains and French Drains
- GBSP 51 – Pipe Underdrains for Structures

The following Articles of the [Standard Specifications](#) (04/01/2016) address the material specifications for various geosynthetic applications. Material specifications are also provided in the above mentioned [GBSP](#)'s.

- Article 1040.07 – Geocomposite Wall Drain
- Article 1080.01 – Fabric Envelope for Pipe Underdrains
- Article 1080.02 – Geotextile Fabric
- Article 1080.03 – Filter Fabric
- Article 1080.04 – Fabric Formed Concrete Revetment Mats
- Article 1080.05 – Geotechnical Fabric for French Drains and Pipe Underdrains, Type 2
- Article 1080.06 – Geosynthetic Soil Reinforcement for Retaining Walls
- Article 1081.10 – Erosion Control Blankets
- Article 1081.14 – Weed Barrier Fabric
- Article 1081.15 – Temporary Erosion Control Materials

Geotechnical Manual

Chapter 8 Geotechnical Construction Inspection

8.13 Erosion Control

Construction activities which strip vegetation and disturb soils accelerate erosion and sedimentation. This accelerated process can result in safety hazards, expensive maintenance problems, unsightly conditions, and disruption of the ecosystems. For this reason, erosion control plans are developed in the design stage to minimize erosion and sedimentation during construction.

IDOT is committed to minimizing erosion within the construction limits of projects and eliminating the movement of eroded material from the highway R.O.W for projects disturbing 1 acre or more, which are subject to the Department's National Pollutant Discharge Elimination System (NPDES) permits.

To acknowledge the importance of erosion control, IDOT established required training as outlined in the [Design and Environment Department Policy D&E-23](#). The intent is to provide the engineering staff with individuals, formally trained in erosion and sediment control Best Management Practices, to oversee the develop erosion control plans and monitor the effectiveness of various erosion control measures in construction. These trained individuals are intended to be utilized to review projects which could potentially be detrimental to the environment, such as existing slopes which are to be denuded.

To review IDOT's policies and responsibilities concerning erosion control, the user of this manual is referred to the following:

- Chapter 9 of the [Drainage Manual](#).
- [Construction Memorandum No. 06-60](#).
- Chapter 41 of the [Bureau of Design and Environment Manual](#).
- Erosion Control in the [Standard Specifications](#).

One significant aspect of Best Management Practices for erosion control in highway construction procedures is the requirement that the area of denuded soils (in each phase of construction) be minimized to the greatest extent possible. This requirement is meant to limit erosion potential. Good practice requires that finishing and revegetation practices closely follow the grading operation. Slopes of deep cuts and high fills are mulched and seeded, in increments.

Geotechnical Manual

Chapter 8 Geotechnical Construction Inspection

Additional procedures which significantly reduce soil erosion are:

- The construction of benches or berms to reduce the flow of surface water down slopes.
- Installation of slope protection, and permanent drains at the earliest practical time.
- The construction of slopes; which are either serrated in soft rock or roughened (plowed) on normal cuts and embankments; so as to retain water, seed, and mulch.
- The construction of perimeter erosion barriers.

Contractors and inspectors shall also follow policies and regulations concerned with proper disposal of project waste materials. Construction activities and surplus excavation should not contribute to erosion or sediment problems. Borrow areas must be routinely surveyed to minimize erosion and sediment damage. Additionally, they should be restored at the earliest practical date.

Geotechnical Manual
Chapter 8 Geotechnical Construction Inspection

This page left intentionally blank.

Appendix A Geology and Pedology

A.1 Introduction

There is a close relationship between geology, pedology, and engineering. This fact should be recognized by all dedicated personnel who are concerned with the design, construction, and maintenance of highways. This relationship is especially valid in the case of highway engineering where highways are built on, through, above, and of earth materials. Unfortunately, most engineers receive, at best, little more than a superficial introduction to geology and pedology.

Pedology is the scientific study of the origins, characteristics and uses of soils comprising the zone, 3 to 6 ft. (1 to 2 m) thick, immediately underlying the earth's surface. An important branch of soil science, pedology is concerned solely with the earth's surficial materials - the outer skin of the soil - as this latter term is frequently used in engineering.

Geology is the scientific study of the origin, history and structure of the earth. Geology provides the basis for differentiating the materials comprising the earth's crust and interpreting the earth's history. In the line of highway engineering, an important contribution of geology is the interpretation of landforms; their history, the processes that shaped them, and the materials that comprise or underlie their surfaces. While pedology deals primarily with the product of surficial weathering; geology is concerned with the underlying material - its character, distribution, and origin. Engineering geology studies help to outline areas of potential slope instability, buried zones of compressible materials, areas of possible surface subsidence, and areas of undesirable bedrock conditions.

Applications of geological and pedological knowledge provide the groundwork for delineating types of earth materials and potential problem zones. Then various sampling methods and tests, from the art of soil mechanics, supply the necessary quantitative data for incorporation into design criteria.

Considerable data has been collected regarding the geology of Illinois: Bulletin 92, "Bibliography and Index of Illinois Geology through 1965", published by the Illinois State Geological Survey,

contains the most up-to-date listing of these works. Another bibliography containing much information regarding the surficial soils of Illinois is found in "Surface Deposits of Illinois", (Univ. Ill. Eng. Sta. Cir. 80). Finally, it should be noted that several Geologists and Engineering Geologists in IDOT are available for consultation, regarding any geological problems that may develop.

A.2 Pleistocene Geology

Since most of the surficial deposits of Illinois are derived from materials laid down during the glacial epoch, referred to geologically as the Pleistocene, some knowledge of the geologic period is most important to the soils engineer. Geologic evidence indicates that during the Pleistocene, in response to periods of cooler temperatures, large masses of ice formed from the consolidation of snow collected in one or more centers of accumulation in Canada. When a sufficient thickness of ice was obtained, the shearing resistance of the ice was overcome and the ice, in the form of glaciers, began to gradually spread out over the North American continent. Studies of the glacial deposits in Illinois and elsewhere have clearly indicated that there were numerous major advances of glaciers, separated by periods of warmer climates and glacier retreat. These major fluctuations gave rise to the Pleistocene shown in [Table A.2-1](#).

There is widespread evidence (see [Figure A.2-2](#)) that parts of Illinois were covered by several glaciers. The Illinois and Wisconsin glaciers entered Illinois as glacial lobes formed by flowage through the lowlands, now occupied by Lake Michigan and Lake Erie. Pre-Illinois glaciers entered the State from both eastern and western source areas. The latest classification of Pleistocene deposits in Illinois is shown in [Table A.2-1](#).

The Wisconsin ice withdrew from Illinois about 13,500 years ago. Geologic history since that time is assigned to the Holocene ("Recent"). Deposits of the Wisconsin episode cover, virtually, the entire northeastern quadrant of Illinois with the exception of Pike and Adams Counties, where pre-Illinois till underlies younger loess. The remainder of the glaciated area of the State is underlain by Illinois episode deposits, covered by a variable thickness of loess. Details of the Pleistocene history of Illinois, as it is reflected in the surficial geologic deposits in the State, are described in the following section.

TIME STRATIGRAPHY		ROCK STRATIGRAPHY				SOIL STRATIGRAPHY		
QUATERNARY SYSTEM	PLEISTOCENE SERIES	<div style="border: 1px solid black; padding: 10px; margin: 0 auto; width: 80%;"> See Figure A.2-1 <i>Stratigraphic Relationships of the Mason and Wedron Group Units</i> </div>				Modern Soil		
		See Figure A.2-1 <i>Stratigraphic Relationships of the Mason and Wedron Group Units</i>				Jules Soil		
	See Figure A.2-1 <i>Stratigraphic Relationships of the Mason and Wedron Group Units</i>					Farmdale Soil		
					See Figure A.2-1 <i>Stratigraphic Relationships of the Mason and Wedron Group Units</i>			
See Figure A.2-1 <i>Stratigraphic Relationships of the Mason and Wedron Group Units</i>				Chapin Soil				
				See Figure A.2-1 <i>Stratigraphic Relationships of the Mason and Wedron Group Units</i>				Sangamon Soil
See Figure A.2-1 <i>Stratigraphic Relationships of the Mason and Wedron Group Units</i>								Pike Soil
				See Figure A.2-1 <i>Stratigraphic Relationships of the Mason and Wedron Group Units</i>				Yarmouth Soil
See Figure A.2-1 <i>Stratigraphic Relationships of the Mason and Wedron Group Units</i>								Afton Soil
				See Figure A.2-1 <i>Stratigraphic Relationships of the Mason and Wedron Group Units</i>				
	WISCONSINAN STAGE (WISCONSIN EPISODE)							
	SANGAMONIAN STAGE (SANGAMON EPISODE)							
	ILLINOISAN STAGE (ILLINOIS EPISODE)	Loveland Silt	Teneriffe Silt	Pearl Fm.	Glasford Fm. Berry Clay M. Radnor T.M. Toulon M. Hulick T.M. Duncan Mills M. Kellerville Till M.	Berry Clay M. Sterling M. Roby M. Hagarstown M. Vandalia T.M. Mulberry Grove M. Smithboro Till M.	Windslow T.M. Ogle T.M.	
	PRE-ILLINOIS GLACIAL and INTERGLACIAL EPISODES	Banner Formation Lierle Clay M. Harkness Silt M. Sankoty Sand M. Mahomet Sand M.						
		Enion Formation				Mounds Gravel Grover Gravel		

Table A.2-1 Stratigraphic Classifications of the Pleistocene Deposits in Illinois

(From Bulletin 94 and Bulletin 104 (1996), Illinois Geological Survey)

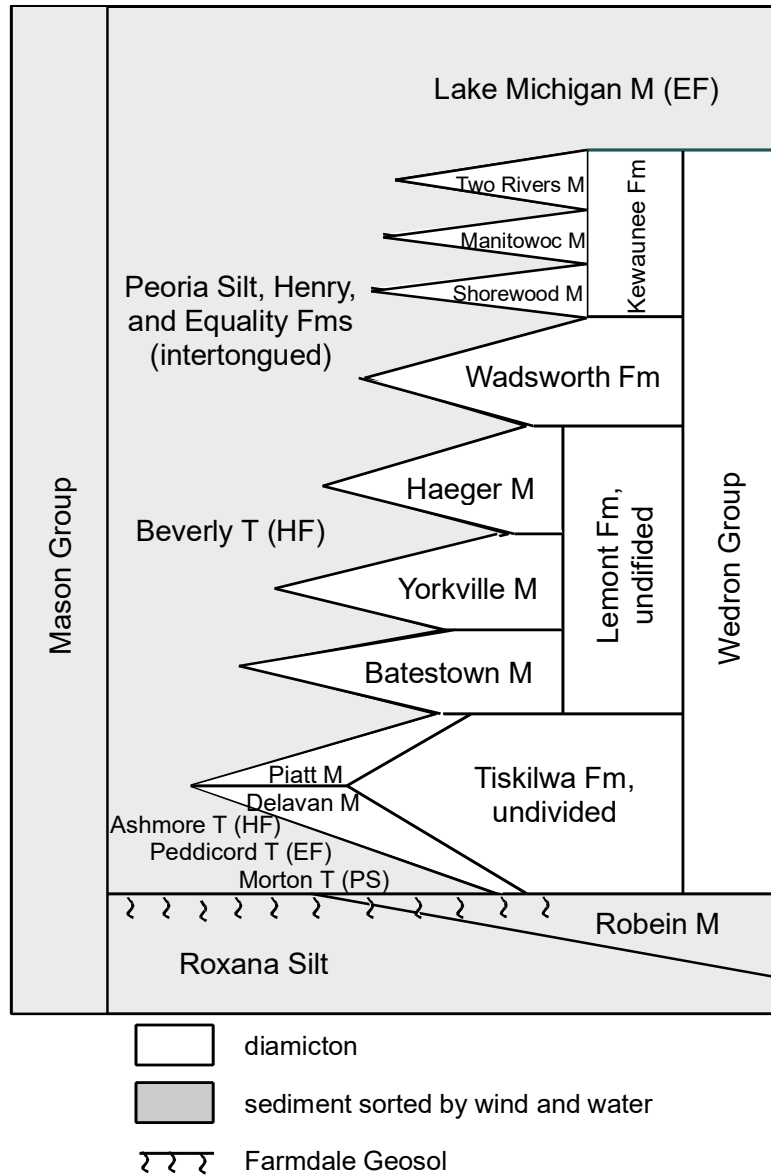

Figure A.2-1 Stratigraphic Relationships of the Mason and Wedron Group Units

For recent discussions of the Pleistocene in Illinois, reference should be made to the Illinois State Geological Survey’s Bulletin 94, “Pleistocene Stratigraphy of Illinois”; and Bulletin 104, Wedron and Mason Groups, “Litho-stratigraphic reclassification of deposits of the Wisconsin Episode, Lake Michigan Lobe area” (1996).

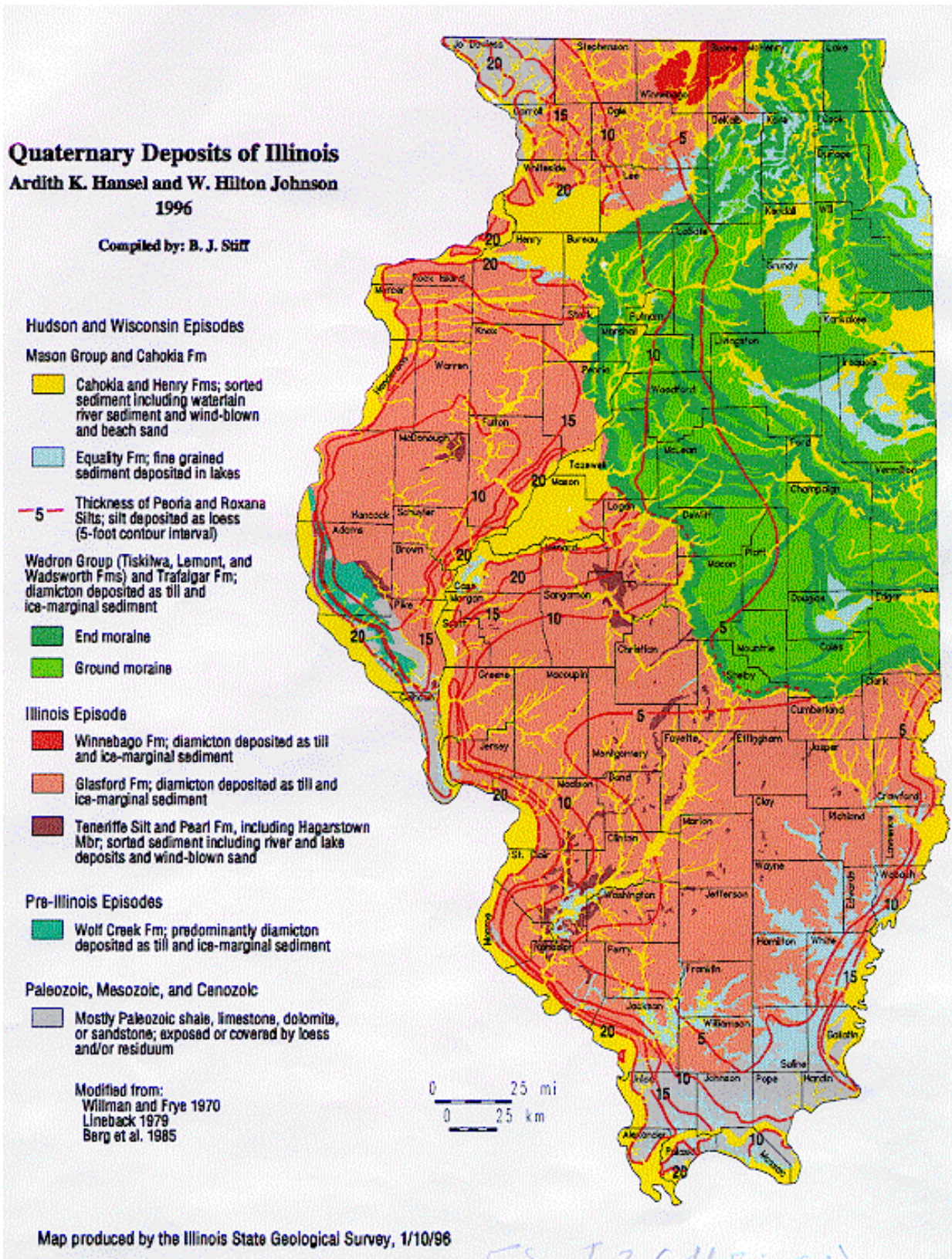

Figure A.2-2 Quaternary Deposits of Illinois

A.3 Pre-Pleistocene Geology

The bedrock geology of Illinois is shown in [Figure A.3-1](#). The classification and general description of these bedrock units are presented in [Table A.3-1](#). Virtually all of the bedrock, in the sense of hard indurated or consolidated rock, was deposited as sediments during the Paleozoic Era. These sediments (through the processes of consolidation, cementation, and crystallization) have been transformed into sedimentary rocks. Principal varieties of these rocks include shale, limestone and dolomite, sandstone, and coal. Descriptions, characteristics, and engineering problems for these rocks are presented in a following section.

Pre-Pleistocene unconsolidated sediments of Cretaceous and Tertiary episodes are found in two areas in Illinois. In extreme southern Illinois, (Alexander, Pulaski, and Massac Counties) these clay, sand, and gravel deposits lie in the northern end of the Mississippi Embayment. Similar deposits, (formerly identified as Illinois drift) in Pike and Adams Counties, are now also classified as Cretaceous.

The bedrock layers have been bowed downward by forces within the earth, forming the Illinois Basin. Thus, the youngest Pennsylvanian rocks underlie south central Illinois and progressively older rocks are found outward from this area.

The dips of the sedimentary rocks into the basin are generally quite small, and for practical purposes, (as in a single road cut) the rock layers are essentially horizontal. Specific exceptions are in the vicinity of the LaSalle Anticline near Starved Rock State Park; Cap Au Gres Fault in Calhoun and Jersey Counties; and the Dupon-Waterloo Anticline in Monroe County, where steeply dipping rock layers are present.

In eastern and northern Illinois, the basinal structure has been modified by secondary folding, to form the LaSalle Anticlinal Belt and the Kankakee Arch. The bedrock units in southern Illinois have been broken by a series of faults - fractures, along which there has been some differential movement in the geologic past. None of these are known to be active today. Occasional tremors are felt about once a year, and on average, about once every 10 years a tremor may cause slight damage.

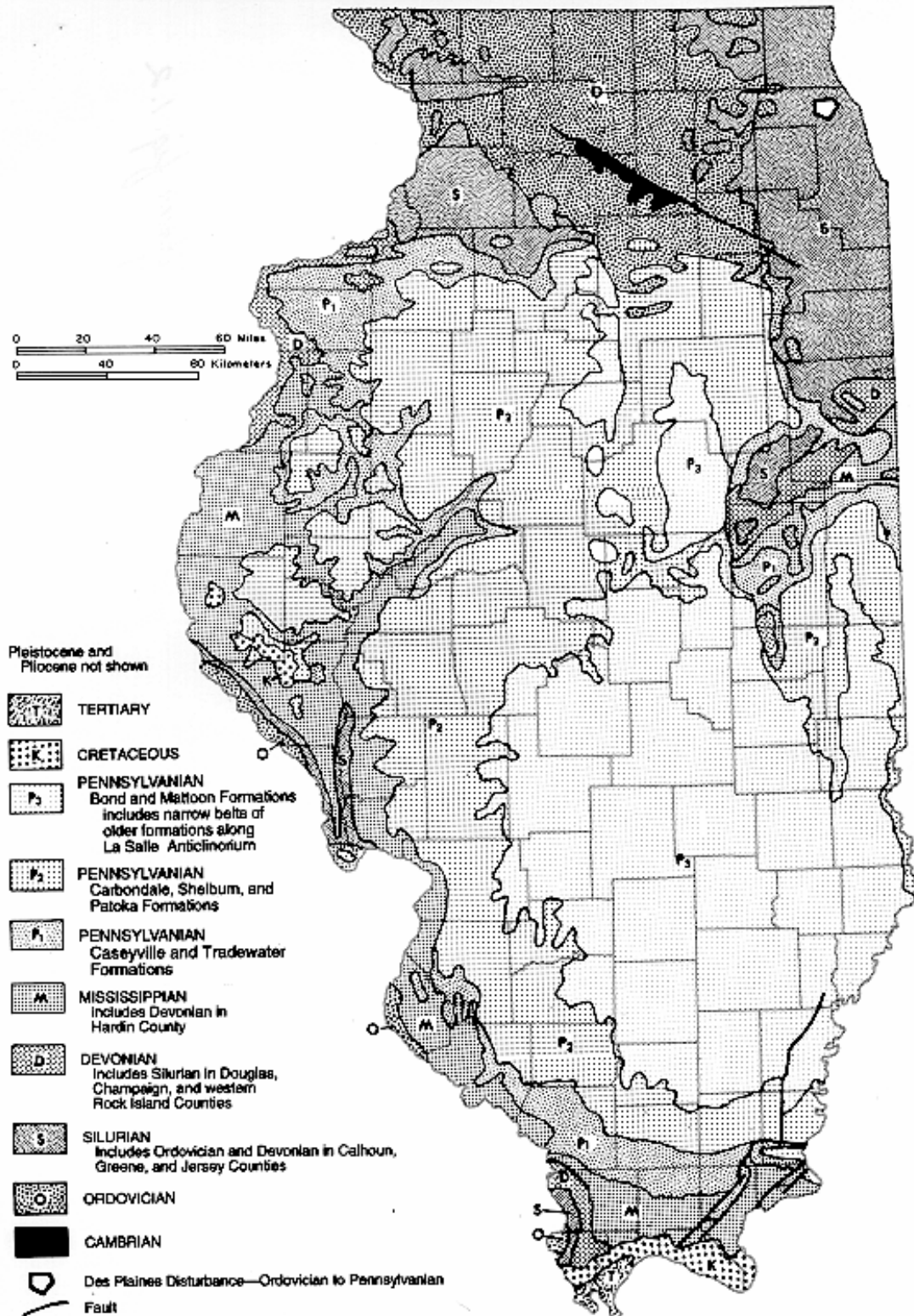

Figure A.3-1 Generalized Areal Geology of the Bedrock Surface of Illinois

(From Illinois State Geological Survey – Bulletin 94)

Time Scale	Geologic System	Series, Group, or Formation	Maximum Thickness (meters)	Bedding Resistance to Weathering	Character of Deposit	
Millions of Years Ago	1-2	Quaternary	Glacial Drift	152		Till, Gravel, Sand, etc.
	20	Pliocene	Mounds Gravel	15		Gravel, Sand, Clay, Lignite
	54	Eocene	Wilcox Fm. Porters Creek Clay	91		
	67	Paleocene	Creek Clay	53		
	135	Cretaceous	McNairy Fm.	145		
	265	Pennsylvanian	Mattoon	213		Shale with Sandstone, Limestone, Coal and Clay
			Bond	107		
			Patoka	91		
			Shelburn	61		
			Carbondale	122		
			Tradewater	213		
	320	Mississippian	Caseyville	183		Sandstone with Shale
			Pope Group	365		Alternating Shale-Limestone and Shale-Sandstone Formations
			Ste. Genevieve L.S.	61		Thick Limestones with Thin Shales
			St. Louis Limestone	152		
			Salem Limestone	122		
			Warsaw Shale	61		
			Keokuk-Burlington L.S.	91		Shale with Limestone
	355		Devonian	Chouteau L.S.-Hannibal Shale		
				New Albany Shale		125
	St. Laurent/Cedar Valley			67	Limestone	
	Grand Tower Wapsipinicon	61		Chert		
	Clear Creek	183				
	Backbone Limestone	46				
	Grassy Knob Chert	76	Limestone			
405	Silurian	Bailey Limestone	137	Chert		
		Cayugan Series	332	Limestone		
		Niagaran Series		Dolomite R = Reef		
		Alexandrian Series				
445	Ordovician	Maqoketa Group	107	Shale		
		Galena (Kimmswick) Group	91	Dolomite-Limestone		
		Platteville (Plattin) Group	177	Limestone-Dolomite		
		Glenwood St. Peter Sandstone	198	Sandstone		
		Shakopee Dolomite	122	Dolomite		
		New Richmond Sandstone	53			
	Oneota Dolomite	91				
	Gunter Sandstone	24				
500	Cambrian	Eminence-Potosi Dolo	100	Dolomite		
		Franconia Formation*	79			
		Ironton-Galesville SS.	70			
		Eau Claire Formation	175			
		Mt. Simon Sandstone	884			
570		PreCambrian	Crystalline Rocks			Igneous and Metamorphic Rocks

* Lowermost Outcrop in Illinois

Table A.3-1 Principal Bedrock Strata of Illinois

A.4 Physiographic Divisions

Much of the surface of Illinois is essentially a prairie plain, which presents few striking physiographic contrasts. The relief over most of the State is moderate to slight. Although large-scale relief features are absent, several physiographic divisions can be made, and these assume great local significance. Each of the physiographic subdivisions, shown in [Figure A.4-1](#), has a distinctive surface topography which, in turn, reflects its geologic history and the character of the surficial deposits. An example of utilizing this data can be made with the Kankakee Plain. This is an area of poor drainage, flat topography, and is predominantly silty and clayey materials. Such materials were deposited in temporary glacial lakes, formed during the final deglaciation of Illinois. The physiographic data do not reflect the thickness of the lake deposits, nor the character of the underlying glacial materials, both of which are variable.

More than nine-tenths of the State lies within the Central Lowland Province. This province was glaciated, except in the Wisconsin Driftless Section of northwestern Illinois. The other provinces (Ozark Plateaus, Interior Low Plateaus, and Coastal Plain) lie almost entirely outside of the glacial boundary, in extreme southern and southwestern Illinois.

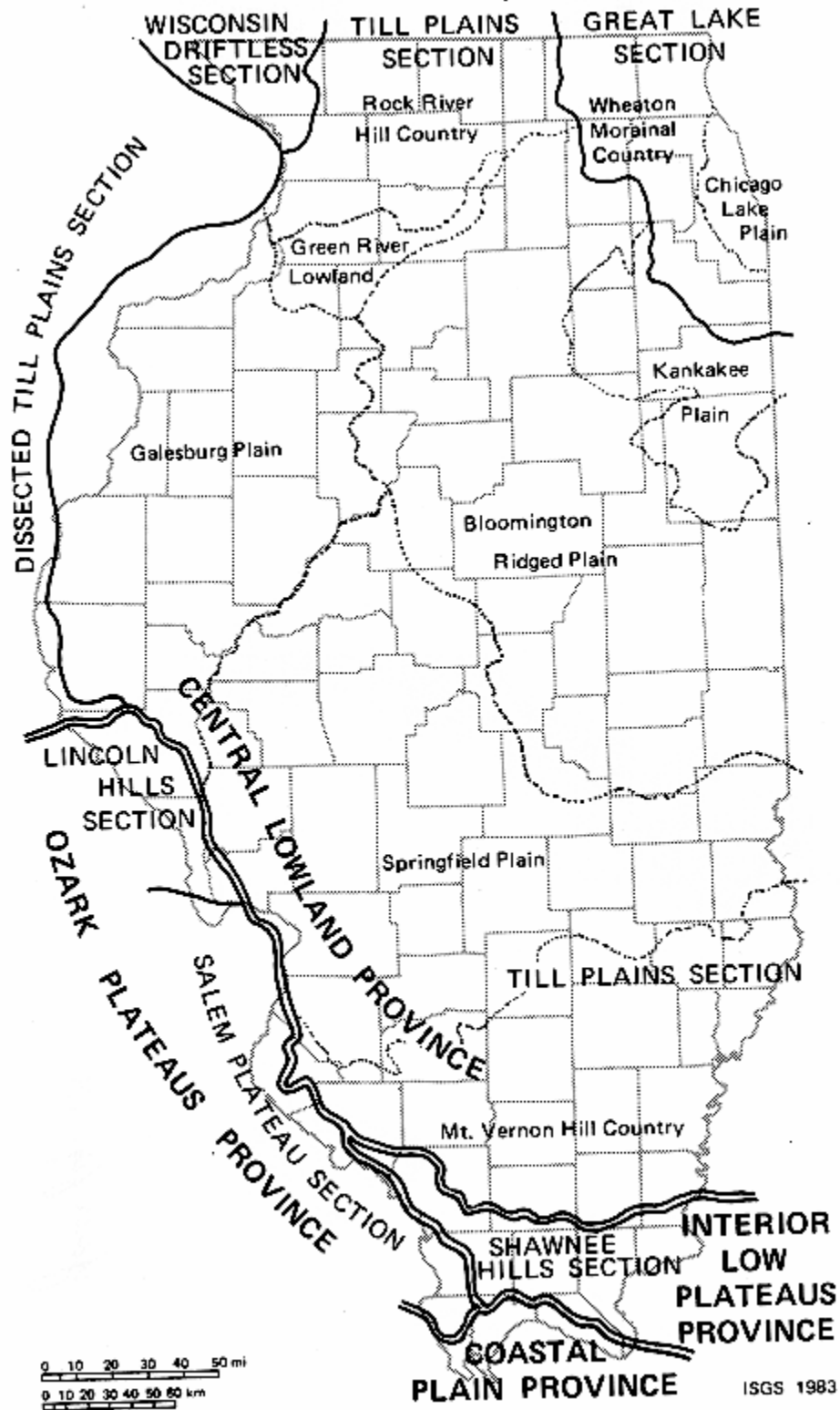

Figure A.4-1 Physiographic Divisions of Illinois

A.5 General Character of Glacial Deposits

As generally used today, the term **glacial drift** or **drift** embraces all the material (clay, silt, sand, boulders) deposited directly or indirectly by glaciers; in upland areas, in rivers and valleys, in lakes and ponds; and in the ocean, as a result of glacial activity in adjacent regions. It includes: till, stratified drift or outwash, and scattered rock fragments (“erratics”).

The deposit of glacial drift, carried by the ice and laid down directly from it as it advanced or retreated, is known as **till**. Till is typically a heterogeneous mixture of particles, ranging in size from fine clay to large boulders. Theoretically, its textural composition may vary from 99% boulders to 99% clay size; but actually, such extremes are rare. Ideally, a till deposit has not been affected by the presence of water, either running or standing, and consequently shows no evidence of sorting by particle size. However, a typical till deposit may contain local deposits, or inclusions, of water sorted material. Much till was reworked as the glacier melted at or near the ice margin. Such reworked till may be called diamicton.

A large portion of the rock and soil material transported by glacial action was not deposited directly from the ice. It was incorporated into and carried by streams of meltwater, flowing within or in front of the melting glacier. This subsequent handling of the material, by water, always resulted in some sorting of the particles and produced evidence of stratification in the deposit. Such material can be classified, generally, as stratified drift. These glacio-aqueous deposits may, in Illinois, be subdivided as (1) **glacio-fluvial** deposits, where the material has been laid down through the action of flowing water; (2) **glacio-lacustrine** deposits, where the material has been laid down in quiet, fresh water.

Each of these deposits, outlined generally above, are described in detail in the following section, with particular regard to their geologic and topographic development in Illinois.

A.5.1 Ground Moraine or Till Plains

Nearly level, to gently undulating till plains are the predominating physiographic feature of much of the State of Illinois. These plains were formed as a result of the deposition of glacial debris, directly from the base of the ice, as it moved. As the name implies, glacial till is the principal constituent of these deposits. The term **ground moraine** is used, more or less, interchangeably with till plain, and implies the same origin. Normally, a section through a till sheet, of a uniform

episode, should show little evidence of stratification or sorting; however, a typical till deposit may contain local deposits, or inclusions of sorted material. In central and northeastern Illinois, the accumulative thickness of the several till sheets of Wisconsin and Illinois episodes often exceed 100 ft. (30 m). The local topography, which is of the order of 30 ft. (9 m) or less, is due, generally, to the constructive action of the glaciers. In southern Illinois (south of Mt. Vernon) where the till is solely of Illinois episode, the total thickness of the till sheet is often 20 ft. (6 m) or less, and the topography is controlled almost entirely by the underlying bedrock. Reference should be made to [Table A.2-1](#), to see the position of these till formations in the entire Pleistocene stratigraphic classification; and to [Figure A.2-2](#), to see their distribution.

The textural composition of the glacial till is of primary importance, in determining the character of the soils in northeastern Illinois. In the region covered by the Wisconsin ice sheet, the surface soils have been developed from tills of the Wedron Group; they vary in texture from loamy gravel to clay. Since these materials are relatively young geologically, the characteristics of the till are closely reflected in the textural characteristics of the surface soils. At depths of 3 ft. (1 m) or more, the character of the till is practically unaltered. Tills can be classified according to texture, using the USDA/NRCS textural classification diagram shown in [Figure A.5.1-1](#). This classification should not be confused with the Illinois textural classification of [Figure 5.5.5.1-1](#). [Figure A.5.1-2](#) illustrates particle size properties of the following six textural groups, which have been described by Illinois pedologists:

- 1) Loamy gravel drift. This material is, normally, non-plastic to slightly plastic, and contains from 60 to 90% of combined sand and gravel. Rarely does the content of fine grained material exceed 10%. Although deposits of this material often show some evidence of stratification, enough examinations have been made to indicate that many have a till-like character.
- 2) Sandy loam till. Material of this classification is also relatively non-plastic and very similar to the loamy gravel till, except that the content of gravel size material seldom exceeds 30%. The content of fine grained material averages about 25 to 30%.
- 3) Silt loam and loam till. These materials have a combined sand and silt content which averages close to 70%. Seldom does the fraction of gravel size exceed 10%, and the clay size fraction averages close to 20%. The materials in this textural group have sufficient clay to render them, at least, moderately plastic.

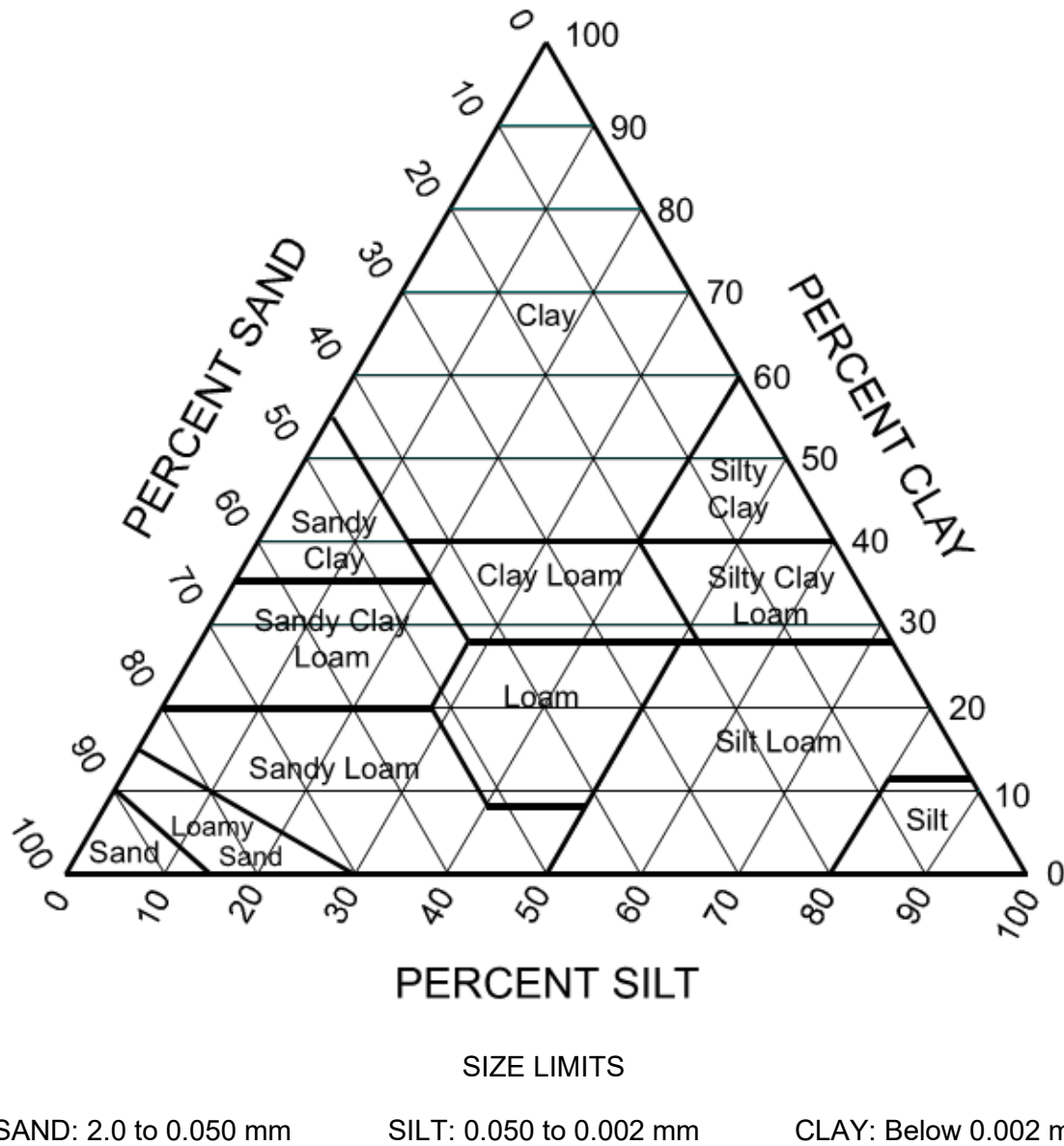

Figure A.5.1-1 USDA/NRCS Textural Classification Diagram

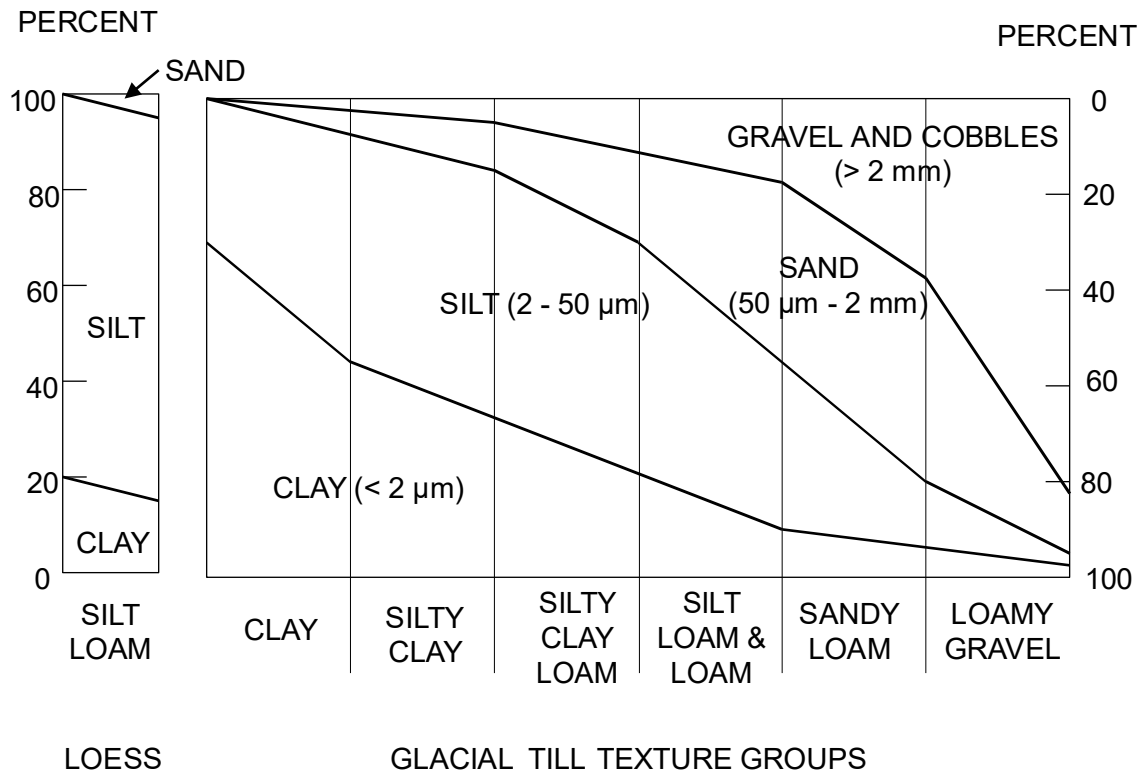

Figure A.5.1-2 USDA/NRCS Textural Classification of Loess and Tills

- 4) Silty clay loam till. The materials in this textural group differ from the loam tills, by having about 10% lower sand content and a corresponding greater clay content. They are moderately to highly plastic, and they have a combined silt and clay content averaging close to 80%.
- 5) Silty clay till. These materials are highly plastic and have a clay content averaging close to 40%. The combined sand and gravel content seldom exceeds 15%.
- 6) Clay till. The materials in this group have a content of clay size material, which is seldom less than 45% and sometimes exceeds 70%. Commonly, these very highly plastic materials have a combined silt and clay content close to 95%.

In addition to the differences in the textural and plasticity characteristics of the till, there are differences in the surface soils brought about by variations in relief and drainage characteristics. The dominant landform is a level to gently rolling plain in which, for the most part, the natural

drainage system has not been well developed. However, many artificial drainage ditches have been dredged across the countryside in order to cultivate the low areas, between the knolls and ridges. Although erosion is not severe on most of the rises, soil profile development is often shallow. Gullying is unusual, but sheet erosion has undoubtedly been active. In contrast, the lower areas or basins on the till plain surface are often filled with the accumulation of mineral matter (washed from the surrounding higher land) and are combined with the remains of plant vegetation (formed under swamp conditions). Even where the underlying till is relatively coarse-textured, the water table may be high in the basin areas; with the result that the surface soils are usually high in organic matter.

Surficial soils in the areas of Illinois, (Glasford and Winnebago Formations) and older (Wolf Creek Formation) ground moraine, do not reflect the different till textures as found in the northeastern part of the State. In these loess covered areas, the modern soil is developed in the loess. However, an older soil profile of greater thickness is usually present, developed in the underlying till, either Illinois or pre-Illinois. In these areas, a soft, moist, plastic, clayey material (of variable thickness) is frequently found overlying the weathered till. In older literature, this material was called “gumbotil”. However, today, much of these deposits are identified as being “accretion-gley.” One of the best examples of a buried soil is the “Sangamon Soil”, which was developed on Illinois and pre-Illinois drift, prior to the deposition of the Wisconsin loesses. The clayey B horizon of the truncated soil profile, usually, has a distinctive reddish-brown hue; when under drained (oxidizing) conditions are present.

A.5.2 Morainic Ridges or Moraines

Wherever the position of the ice front remained relatively stationary (due to a balance between the forward movement of the ice, and the melting and evaporation taking place at the front of the ice) the natural forward “conveyor-belt” motion of the ice brought much rock debris to the front of the glacier, where it was dumped. When (in response to increased melting) the ice front withdrew from the area, these deposits were left as a hilly ridge marking the former temporary position of the ice front.

These ridges are called ***morainic ridges***, ***end moraines***, or simply ***moraines***. They are prominent topographic features of the landscape in the Wisconsin drift area, in the northeastern part of the State (see [Figure A.2-2](#)). They are much less prominent in the Illinois drift areas.

In Illinois, the local relief within morainal areas seldom exceeds 50 ft. (15 m). However, the relief between the crest of the moraine and the surrounding country may approach 200 ft. (60 m). In contrast to the till plain regions, the drainage conditions on the moraines are usually good. However, local closed depressions called **kettles** (which resulted from the melting of isolated blocks of ice within the drift) are often present. The width of moraines varies from sharp well-defined ridges, to broad hilly areas several miles wide. Many moraines can be followed for miles across the country, whereas, others exist only as isolated remnants.

The principal constituent of the moraines, in Illinois, is glacial till. However, because of the active melting which took place while the ridges were being formed, they contain much more water worked material than is normally found in the till of the plains. Due to the method of formation, moraines are usually found to contain pockets and lenses of water sorted gravels, sands, and silts. Locally, they may even contain water sorted silts and clays, which have been laid down in temporary ponds. As in the case with the till plains, the characteristics of the till itself may vary from one moraine to another. In some cases, even within a single moraine, the texture of the till has been found to vary from one part of the State to another. Because of this fact, it has been impossible to formulate any precise correlations between the engineering properties of the glacial drift and any particular moraine or group of moraines, although certain generalizations can usually be made.

A.5.3 Outwash Plains

While the ice front remained relatively stationary during the building of an end moraine, much water was flowing off the front of the ice and carrying with it glacial debris of varying sizes. A natural sorting and stratification took place when these materials were deposited, in the form of a discontinuous apron or **outwash plain** which sloped, very gradually, away from the end moraine.

Many outwash plains are indicated on the Quaternary Deposits of Illinois map ([Figure A.2-2](#)). Some of these outwash plains occupy many square miles, although the thickness of the water sorted materials may vary considerably. Normally, coarse-textured sand and gravel, and the thickest deposits occur immediately in front of a morainic ridge. A gradual decrease in the particle size and thickness of outwash takes place at successively greater distances from the ridge front, until the deposit of silt and sand becomes so thin that it is impossible to distinguish it from the underlying till material. Because of this variation, it is difficult to predict with any high degree of

accuracy, the character of an outwash deposit at any given location. Most of the outwash of the last glaciation is classified as Henry Formation.

A.5.4 Alluviated Valleys

Closely associated with the outwash plains are the deposits of water-sorted material laid down in the major stream valleys; such, as the Mississippi, Illinois, Kaskaskia, Wabash, and Ohio Rivers. These and other streams functioned during the Pleistocene as major drainage ways for glacial meltwater, and consequently, their valleys contain much of the outwash material carried away from the glaciers. Evidence indicates that during glacial times these major drainage ways, at various episodes, rapidly filled or partially filled their valleys with outwash from melting glaciers. Subsequent to the withdrawal of the ice sheets the behavior of the streams changed and, because of the reduction in sediment load, the present rivers have cut down through the Pleistocene outwash deposits, leaving them exposed as terraces along the valley walls. The number and size of terraces vary considerably with the size of the stream, and with its importance as a glacial drainage outlet. In many cases, the terrace deposits have been covered with a layer of loess, and occasionally, sand dunes. However, at depths of 10 ft. (3 m) or less, granular outwash materials will usually be encountered. Valley terraces constitute one of the major sources of granular material in Illinois and adjoining states. The Quaternary Deposits of Illinois map ([Figure A.2-2](#)) shows the location of the major alluviated valleys, but it is not possible to say, with certainty, that granular materials of high quality will be found in any specific location in these valleys. The study of aerial photographs or the examination of special materials resource maps will help in locating high quality materials. Underlying the floodplains, along the major drainage ways (noted above), the coarse grained outwash is present, beneath a cover of recent fine grained alluvium, generally, 10 to 30 ft. (3 to 9 m) thick. Recent alluvium is classified as Cahokia Formation.

A.5.5 Glacial Lakebed Sediments

In the Illinois drift regions, tributary streams draining the upland were not able to build up their valleys as rapidly as the major drainage ways of the Mississippi, Illinois, Kaskaskia, and Wabash Rivers. For this reason, the tributary outlets were sometimes blocked during Pleistocene times, and their valleys became temporary lake beds. Some of the water from the major drainage ways flowed into these lakes. The most important and extensive areas of these lakebed sediments (especially along the Big Muddy River Valley and in southeastern Illinois along the Wabash River Valley) are delineated on the Quaternary Deposits of Illinois map ([Figure A.2-2](#)), and in [Figure](#)

[A.5.5-1](#). Under the conditions which prevailed in these areas, fine grained lacustrine sediments (“slackwater deposits”) were deposited. These deposits are in marked contrast to the sediments found in the major stream valleys draining the Wisconsin ice front. After the retreat of the glaciers, as the major streams cut down through their previous deposits, the tributary valleys were drained. Frequently, the tributaries were incised into the slackwater deposits, and terraces were formed along the valley walls. Sometimes these deposits may be covered with a layer of recent alluvium. However, in the principal tributary valleys, fine grained plastic sediments will usually be encountered at a relatively shallow depth. Only a detailed geological investigation can determine if the basic deposit is lacustrine or alluvial in character.

As the Wisconsin, Lake Michigan ice lobe withdrew from northeastern Illinois, meltwater was periodically impounded between the major end moraines and the retreating ice front. These temporary glacial lakes covered large areas. Geologic investigations indicate that the history of such lakes was quite complex. During some periods true lacustrine conditions prevailed, but during other times water was flowing through the lakebed areas at sufficient velocity to prevent the deposition of much clay. Several areas of lakebed sediments are indicated on the Quaternary Deposits of Illinois map ([Figure A.2-2](#)) and on [Figure A.5.5-1](#), which includes their assigned names. Bars and beach ridges were built in and along these lake areas. Subsequent to their formation, these sandy deposits were reworked by the wind. Thus, the character of the surface deposits found in these areas may be quite variable, ranging from almost clean sands along the outer edges of the lakes, through sandy silt, to fine-textured clays in the central part of the lakebed area. Occasionally, the morainal dam would be breached, and the ponded meltwater would flood the Illinois Valley. A series of such floods, late in the Wisconsin, is collectively referred to as the Kankakee Torrent. Sand bars formed by these floods are numerous along the Illinois Valley, especially in the Peoria to Beardstown stretch.

The materials deposited in the temporary glacial lakes, described above, are assigned to the Equality Formation. This formation has been subdivided into two members: the Carmi Member, which consists of relatively deep water lacustrine silts and clays; and the Dolton Member, consisting of coarse grained sediments.



Figure A.5.5-1 Glacial Lakes of Illinois

Areas of lakes overridden by glaciers not shown.
(From Illinois State Geological Survey – Bulletin 94)

A.5.6 Ice-Contact Stratified Drift

Associated with both the Wisconsin end moraines and till plains, and with the Illinois drift areas are deposits of stratified drift; which were initially deposited by meltwater streams on, under, or adjacent to the glacier itself. These deposits are generally classified by their topographic expression. **Eskers** are sinuous ridges of sand and gravel deposited in meltwater streams, flowing in tunnels at the base of the glacier. **Kames** are conical hills of sand and gravel. **Kames** were initially deposited in depressions on the glacier's surface, and then dropped when the ice melted. Both of these deposits suggest stagnation and melting "in-place" of the glacier. Such deposits are common in the northeastern part of the State, and they have been extensively worked there. Also, in northeastern Illinois (specifically in McHenry County) are **kame terrace** deposits, which are composed of sand and gravel deposited along valley sides, adjacent to a glacier. Isolated kames and eskers are occasionally found in areas of Illinois drift. However, because of subsequent weathering, the deposits cannot qualify as high quality aggregate. Ice-contact Wisconsin drift is classified as Henry Formation.

Elongated ridges of Illinois drift, generally trending NE-SW, in south-central Illinois (north of the Kaskaskia River Valley) are currently interpreted as representing, in large part, deposits laid down during large scale stagnation of the Illinois glacier in this region. Ice-contact Illinois drift is classified as Pearl Formation.

A.6 Wind Deposits

Closely associated with glacial till and outwash deposits are deposits which have been shaped or laid down by wind action. In Illinois, these wind sediments are predominantly materials which were first eroded and moved by glaciers, and then carried and sorted by water. Subsequently, these water deposited sediments were modified by wind action. The physical nature of moving air will limit the handling of particles which are no larger than coarse sand; and because of the cohesive characteristics of clay size material, wind will transport clays only under special conditions. Consequently, deposits of windblown material fall into two groups. Sand-size materials ordinarily are not transported over great distances by wind action. Therefore, windblown sand deposits are frequently located close to the source. These sand deposits occur topographically as dunes. Silt-size materials, because of their finer size, can be winnowed out of the sand. Silt-size materials are carried to a greater height by the wind and deposited further from

the source. Accumulation of silt-size materials rarely show evidence of stratification within a deposit of given age. Accumulations of wind-blown, silt-size materials are called loess.

A.6.1 Sand Dunes

Sand dune deposits are found, most often, in association with beach ridges, or on major outwash or terrace deposits; usually, in or immediately adjacent to major alluviated valleys (see [Figure A.6.1-1](#)). As a result of previous handling by glacial ice and by water, the predominant mineral in most Illinois sands is quartz. When these materials have been further sorted by wind, they are practically inert and extremely resistant to weathering processes. Typically, they are non-plastic and uniform in particle size. According to the latest Pleistocene classification in Illinois, the sand materials in dunal areas are part of the Parkland facies and are classified either with the Henry Formation or, less commonly, with the Peoria Silt. Today, most of the sand dunes are naturally stabilized by vegetation.

A.6.2 Loess

Loessial deposits blanket much of the present surface of Illinois. As shown in [Figure A.6.2-1](#), the loess thickness varies and obviously reflects the distance from its source. Loessial deposits are predominantly silt-sized materials, which were picked up by the wind from the floodplains of glacial drainage ways and deposited on the adjacent uplands. Along with the pronounced thinning downwind from the source area, there is also a corresponding change downwind; from a coarse sandy loess (adjacent to the source valley), to a clayey loess. As a result of the map scale in [Figure A.6.2-1](#), the maximum loess thicknesses, approaching 75 to 100 ft. (23 to 30 m) along the east sides of the Mississippi and Illinois Valleys, cannot be shown.

The major loess deposits in Illinois are Wisconsin in episode, and consist of the lower Roxana Silt and the overlying Peoria Silt (see [Figure A.2-2](#)). The tongue of the Peoria Silt, that extends beneath the tills of the Wedron Group, is called the Morton Tongue of the Peoria Silt. The Peoria Silt overlies the Wedron Group and extends beyond it, to cover most of the State. The Loveland Silt, a loessial deposit of Illinois episode, is frequently found beneath the younger Wisconsin loesses.

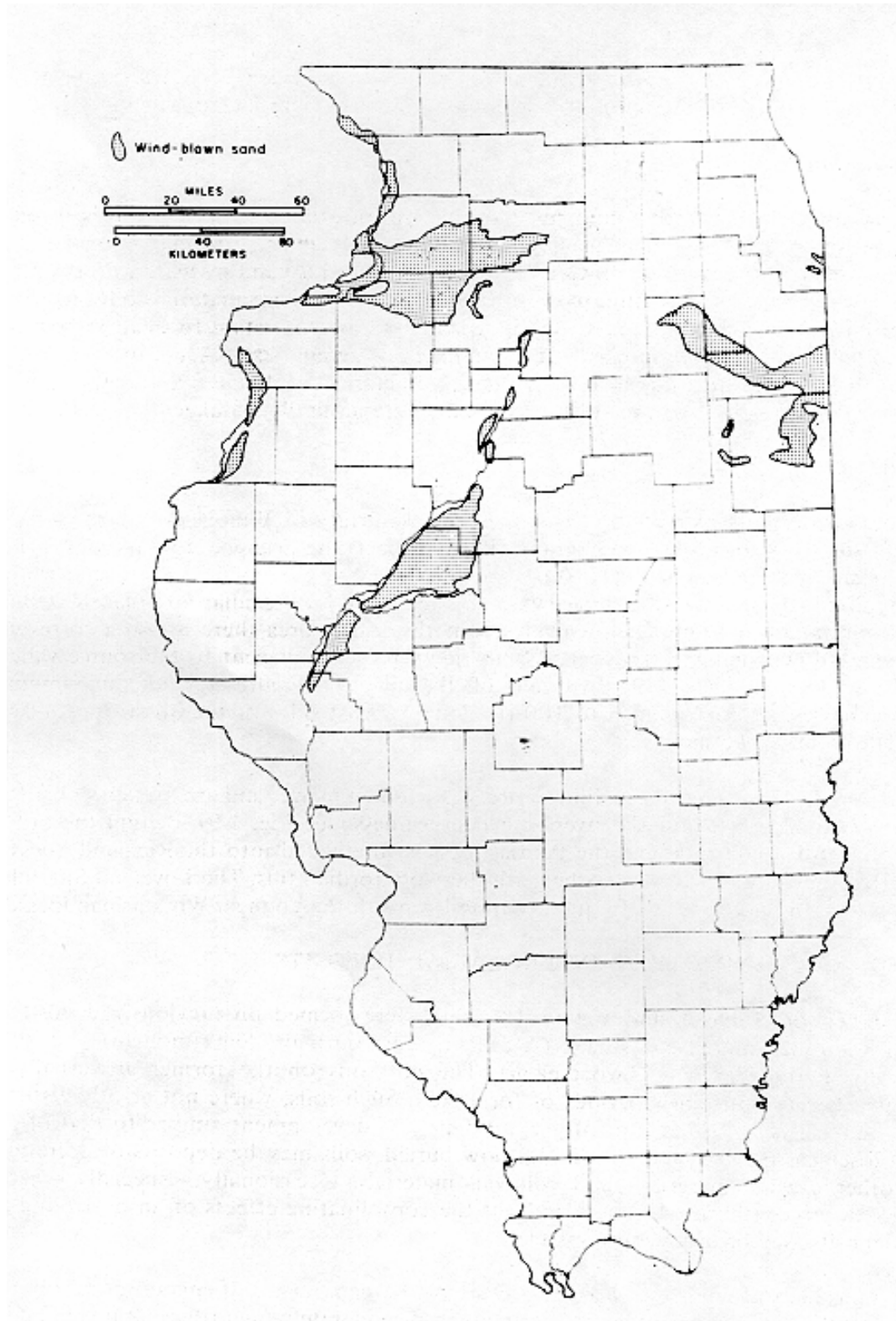

Figure A.6.1-1 Major Areas of Windblown Sand in Illinois

(From Illinois State Geological Survey – Bulletin 94)

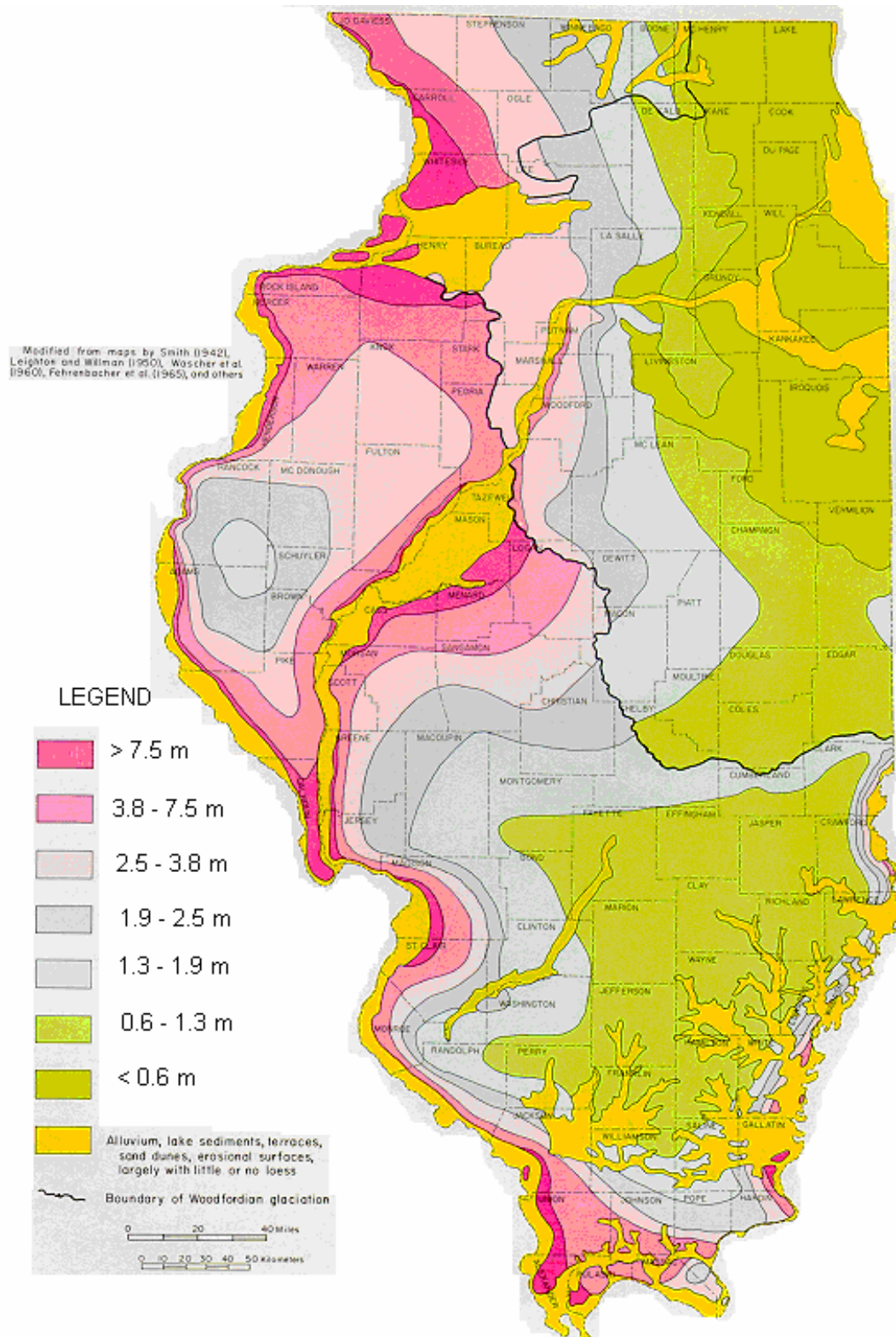

Figure A.6.2-1 Loess Thickness in Illinois

(H.B. Willman and John C. Frye, 1970, Illinois State Geological Survey)

A.7 Organic Deposits

A.7.1 Origin and Classification

Organic soils contain more than 20 to 30% organic matter. They occur in moist to wet locations, where plant remains and, to a lesser extent, animal remains have accumulated in large amounts. Pedologists classify organic soils either as **peat** or **muck**. In peat, the plant remains are well enough preserved to be identified. In muck, the plant remains are so thoroughly decomposed that the plant parts cannot be recognized.

When undrained, muck is a black, structureless ooze. In general, muck comprises the well-decomposed surface material of swamps, and may be underlain by several meters of raw peat.

The most common organic materials from which peat and muck are derived include:

- **Mosses** (principally of the Sphagnum type).
- **Woody plants**; such as, bog conifers, swamp hardwoods, dwarf trees, and heath shrubs.
- **Herbaceous plants**; such as, grasses, sedges, and reeds.
- **Aquatic plants and animals**; such as, water lilies, pondweed, algae, diatoms, and sponges.

In the development of a bog, the succession of plant relationships is very important; since they often develop in episodes, from open water to a filled wooded bog. Thus, under natural conditions, most bogs progress from a flooded episode to drier episodes, in an orderly manner. Around incompletely filled bogs, these successive episodes may be represented by concentric bands of vegetation; from the most advanced episodes at the edge (sometimes partially covered with mineral soil eroded from the upland), to open water in the center.

- 1) Sedimentary Peat. In any shallow lake or pond, the history of a peat deposit begins with the deposition of the remains of aquatic plants and animals; such as, water lilies, pondweeds, algae, and diatoms. These remains tend to disintegrate rather thoroughly (except diatoms which are already very small) and upon settling to the lake bottom, form a finely divided, incoherent, structureless ooze. This type of peat is mostly gray or olive green in color, and it is calcareous. It is soft and smooth when wet, contains about 30%

organic matter, and shrinks greatly on drying to a hard mass; which is readily broken down into a fine powdery dust, when manipulated.

- ◆ Semi-organic sedimentary deposits. These are soft sedimentary deposits of silt, mixed with sand, clay, and organic materials; which are sometimes found in old glacial drainage ways. While they have many of the objectionable features of sedimentary peat, they are generally more stable. Generally, the material is identified as “soft sediments” in boring logs or swamp soundings. The organic content is usually 10% or less; and the water content in the range of 50 to 70%, which is much below that of peat.
- 2) Fibrous Peat. The second episode in the development of a peat deposit is, generally, associated with the encroachment of marsh vegetation upon the lake or pond; in which the groundwater surface is disappearing, as a result of the filling with aquatic plants. This is the most common type of peat in Illinois. It is formed from sedges, reeds, some grasses, and rushes. Fibrous peat appears as a matted or felted, stringy mass that resembles firmly compressed, half-rotted straw. Usually, fibrous peat is brown in color and neutral in reaction, unless it contains large amounts of snail shells or fragments. When freshly exposed, it gives off the distinctive odor of hydrogen sulfide gas. Fibrous peat contains 60 to 70% organic matter, and is high in cellulose, hemicellulose, and lignin.
 - 3) Woody Peat. In the final episode of development of a bog, a swamp forest of conifers and some hardwoods is formed. Under these conditions, the principal source of organic matter is an accumulation of fallen logs, branches, and roots (varying in size and degree of decomposition). Woody peat is commonly quite acid in reaction. This type of peat is common in the northern tier of glaciated states, but it is rare or non-existent in Illinois.
 - 4) Moss Peat. Moss peat differs markedly, in character, from those previously described. It is formed, predominantly, from the small stems and leaves of sphagnum mosses, under a growth of various moss species, combined with scattered sedges and small shrubs. Although it could be classed as a fibrous peat, it differs from that previously described by its highly acid reaction. The occurrence of moss peat is quite limited in Illinois, but it is very common farther north.

- 5) Muck. Most muck in Illinois appears to have been formed from the decomposition of the surface material of a peat deposit. From the engineering standpoint, a qualitative scale of three divisions may be used to classify peat materials which have been partially decomposed: slightly decomposed peat, partly decomposed peat, and well- decomposed peat (or muck). The gradation in decomposition may be judged on the basis of the amount of recognizable plant remains, and a variation in color from brown, to dark brown, to black.

- 6) Marl and Very Soft Clay. In many locations, the deposits of peat are underlain by soft mineral deposits. If the deposit is primarily finely divided calcium carbonate mixed with variable small amounts of peat, sand, and clay, it is called marl. Generally, marl is medium gray to white in color, and is further recognized by its chalky feel and low plasticity. Very soft clay, when present, occurs at the bottom of many swamps and overlies a deposit of glacial drift. Since this clay is unconsolidated, it is usually much softer than the underlying drift, and often more fluid than the overlying sedimentary peat. It usually feels very smooth and sticky, when at its natural moisture content. When excavation and filling occur through a bog, it is usually very difficult to decide how much of the soft clay should be removed. In spite of its exceptionally soft and weak appearance when disturbed, several feet of this material may sometimes be left in place without leading to fill failures. However, settlement of the fills will undoubtedly take place, and its effects must be considered.

A.7.2 Distribution and Occurrence

Approximately one-fourth to one-third of the total area of organic soils in Illinois is peat, and the remainder is muck. More than 90% of the organic soils occur in the northeastern one- fifth of the State, in Districts 1 and 3. The remaining important areas are in the south half of District 2, and along the Illinois River Valley in Districts 4 and 6.

Individual areas of organic soils vary in size, from small spots [less than 1 acre (0.4 ha)] up to more than 1,000 acres (400 ha). The combined area of such soils, in Illinois, is estimated to exceed 250 sq. mi (640 km²). Although this represents only about 0.3% of the total area of the State, these soils are extremely important in the areas where they do occur. When these soils are encountered, special and expensive treatments must be utilized, in order to provide stable subgrades or embankments.

A.8 Buried Soils and Other Interglacial Deposits

As shown in [Table A.2-1](#) and [Figure A.8-1](#), soils were formed on previously deposited drift materials during interglacial episodes; for example (Yarmouthian and Sangmonian); and subepisodes, for example (Farmdalian). The old soils on the former are usually better developed, because of longer periods of formation. These soils, when not greatly disturbed by subsequent glacial action, frequently exhibit profile development similar to that of modern soils. Closely associated with these old, now buried soils, may be deposits of accretion-gley, peat, other organic materials, and colluvial materials. Occasionally, these deposits may be quite compressible. These compressible deposits occur when the soil has been buried by loess, without the consolidating effects of an overriding glacier.

The geotechnical engineer should be aware of the significance of encountering a buried soil zone. The stability of cut slopes, settlement of moderately high fills, and increased loading on foundation piles may be greatly influenced by the materials in such a zone.

A.9 Holocene (“Recent”) Deposits

In Illinois, materials deposited in the last 10,000 years are classified as being Holocene in episode. This name replaces the term “Recent” of former classifications. Holocene episode materials include: valley deposits, depressional deposits, colluvial deposits, and deposits resulting from the activity of man; such as, spoil banks, “gob” piles, and other artificial fills.

A.9.1 Valley Deposits

The nature of the alluvial materials encountered on and immediately underneath the floodplains, in stream valleys, is dependent upon two characteristics. They include the character of the geologic materials in the drainage basin, and the character of the stream. In Illinois, the principal surficial materials are till and loess. Furthermore, most of the tills are not highly granular in nature. Consequently, most of the modern or recent alluvium is of medium texture (silt and fine sand). The character of the stream, which erodes and transports the alluvial material, has an important influence on soil texture. A swift-flowing, high-gradient stream can transport coarse-textured particles. Streams with low gradients will carry the finer-grained materials.

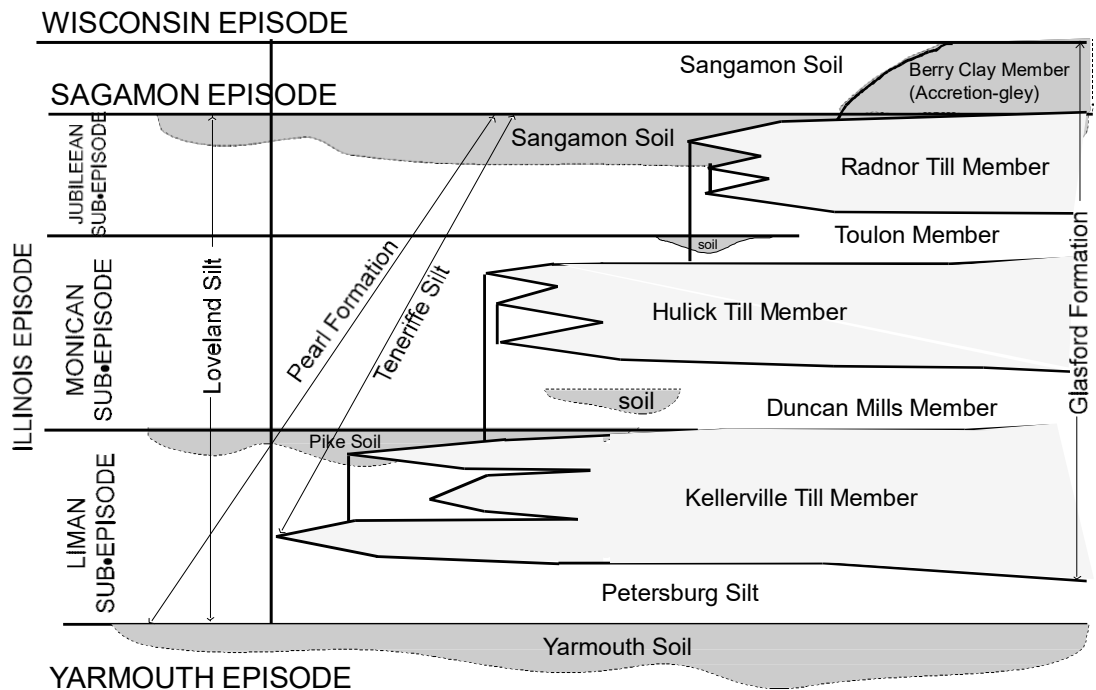

Figure A.8-1 Diagrammatic Cross Section Showing Relations of Pleistocene Formations and Members of Illinois Episode in Western Illinois

(From Illinois State Geological Survey – Bulletin 94)

The floodplains of the large, meandering streams usually exhibit several topographic features, in which characteristic deposits can be expected. The Mississippi River floodplain, throughout most of its length in Illinois, will serve as an excellent model for this description. On the inside of a meander, crescent-shaped low ridges or **point bars** occur, which consist of sandy and coarse silty materials. Occasionally, meandering of the river reaches an episode, where a cutoff across the meander neck develops. Ultimately, the ends of the former meander may become plugged, and an **oxbow lake** formed. With time, this lake will fill with fine grained and organic materials. Low, broad ridges of silty and sandy deposits, called **natural levees**, are formed adjacent to the main channel during floods. Sometimes the development of natural levees prevents tributaries from entering the main stem. In this case, the tributary stream is forced to flow parallel to the main river for some distance before it finally enters it. Streams of this type are called **yazoo streams**. The Sny, in Pike and Calhoun Counties, is an excellent example.

In such a wide floodplain environment, occasionally, stream channels are completely abandoned, producing features called **meander scars**; which are sometimes underlain by relatively coarse grained materials. The floodplain area, between the natural levees and the outer edge of the floodplain (either the valley walls or a terrace face), is frequently a low area (occasionally lower than the river itself) and is often called the **backswamp area**. Typically, very fine grained and organic materials are deposited.

Meander scars can indicate the sites of filled former oxbow lakes. In this case, the surface may be underlain by compressible soils, consisting of fine grained and organic materials. On the other hand, meander scars can also represent abandoned channels in which no lake ever existed. Thus, the surface may be underlain by relatively coarse grained channel deposits.

It is important to note, that while the topographic features and deposits were described above as existing contemporaneously (in a horizontal sense) they also existed in the vertical sense, and frequently in varying positions. Thus, in the section of alluvium overlying the glacial outwash in the Mississippi Valley; filled oxbow lakes, natural levees, and backswamp deposits may be buried under the younger floodplain silts. These were formed as the Mississippi built up its valley floor, while meandering back and forth. Thus, one of the most significant characteristics of alluvium is its variability. This variability can be observed in sections through such deposits, which usually show the lenticular or stratified nature of the materials. These deposits often have a higher permeability in the horizontal, than in the vertical direction.

Furthermore, no significant soil weathering occurs. Fresh materials are deposited whenever the stream goes into flood or changes its position due to meandering. Engineering construction in valley areas, consequently, requires careful and thorough soil exploration procedures. This is required to obtain a reasonable understanding of the deposits.

A.9.2 Depressional Deposits

Small lakes or bogs formed in depressions (created by glacial action) have been filled, not only with mineral matter washed in by eroding streams, but also with the organic remains of swamp plants. Depending upon the relative amounts of mineral and organic materials which have accumulated in a given depression, the soil may vary: from a **peat deposit**, to a dark colored, predominantly mineral soil, which is classified as an **organic silt** or an **organic clay**. As a result of sedimentation and the high water table, which generally prevail in a depressional area, these

deposits normally have high moisture contents. Consequently, serious highway problems may occur because of their compressibility when loaded. In addition, as a result of their high moisture content, the cohesion and resistance to shear of these depressional organic deposits is low. Accordingly, cut slopes in these materials may not be stable.

A.9.3 Colluvium

Colluvial deposits are formed along steeper slopes by the processes of: slopewash and small scale land sliding, flowing, and slumping. The texture of the colluvium reflects its source material which, quite commonly, is loess. Near rocky valley walls, many rock fragments may be incorporated.

A.9.4 Artificial Fill Materials

These highly variable materials reflect the activity of man. They include the following: spoil banks of strip mines and quarries, “gob” piles of underground coal mines, “sanitary” landfills, and the many forms of fills and embankments associated with various engineering and construction projects. Except for the latter types, which were probably placed under varying quality control conditions, most of these materials were not compacted when placed. These materials will also exhibit great ranges in texture, composition, and moisture content.

A.10 Thickness of Pleistocene Deposits – Bedrock Topography

[Figure A.10-1](#) shows the generalized thickness of Pleistocene deposits, in Illinois. The bedrock or Sub-Pleistocene topography is presented in [Figure A.10-2](#). The patterns of thickest drift and the corresponding areas of bedrock valleys outline the major lines of pre-glacial and early Pleistocene drainage. Of major interest is the Teays-Mississippi River System. The Teays River was a major pre-glacial or early glacial stream, originating in West Virginia. After crossing Ohio and Indiana, it entered Illinois in the vicinity of the Iroquois-Vermilion County Line, and it flowed west to join the Ancient Mississippi Valley in Mason County. The Ancient Mississippi River flowed southeast from the modern Mississippi Valley (in Whiteside County), to the Big Bend area (of the modern Illinois Valley), and then down, essentially, the present Illinois River Valley. After a temporary diversion during the Illinoian, a Wisconsin glacier finally diverted the Mississippi River through the Rock Island area; where it, ultimately, flowed into the Ancient Iowa River, which occupied the present Mississippi Valley (south of Keokuk, Iowa).

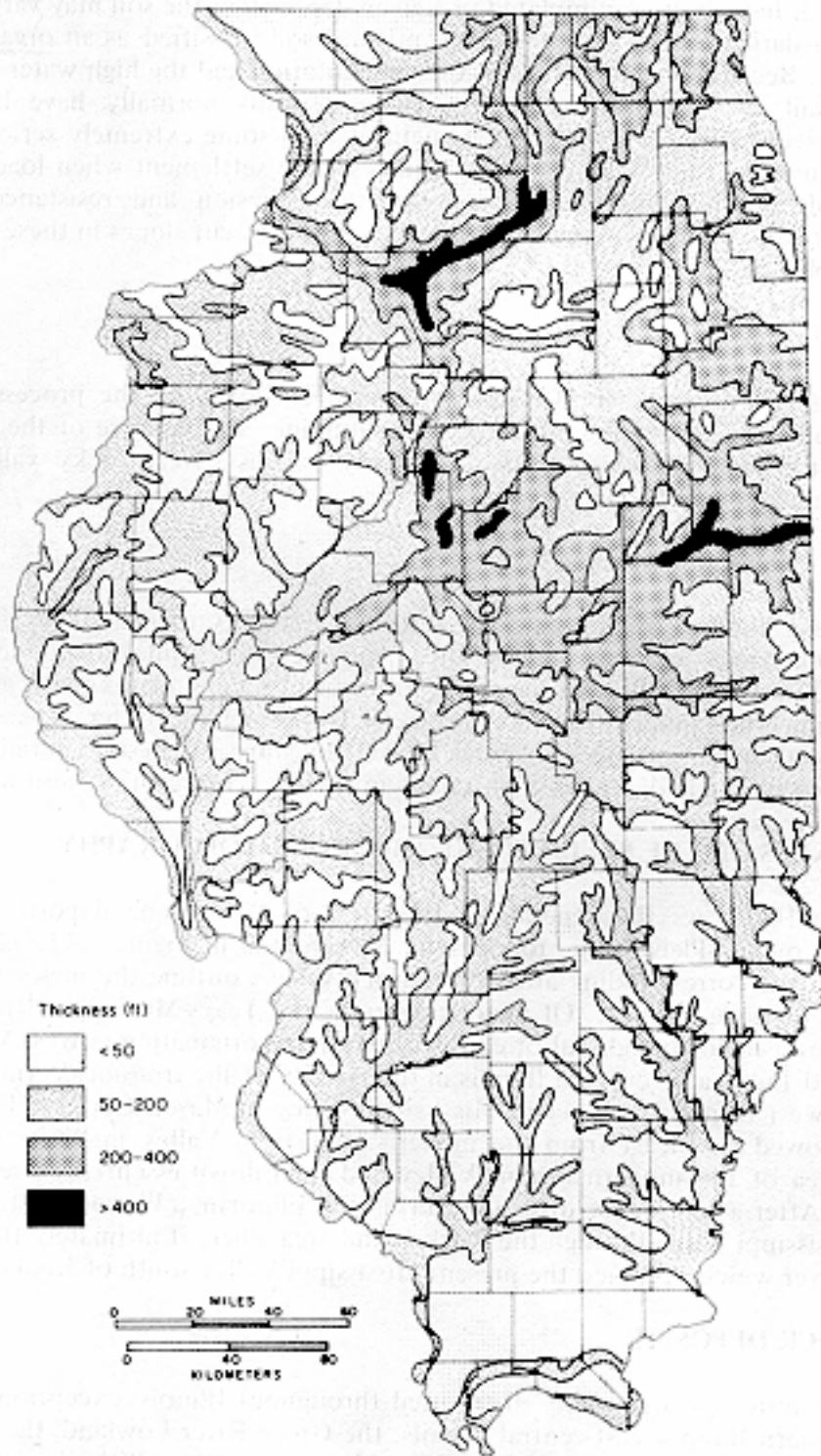

Figure A.10-1 Thickness of Glacial Drift of Illinois
(From Illinois State Geological Survey – Bulletin 94)

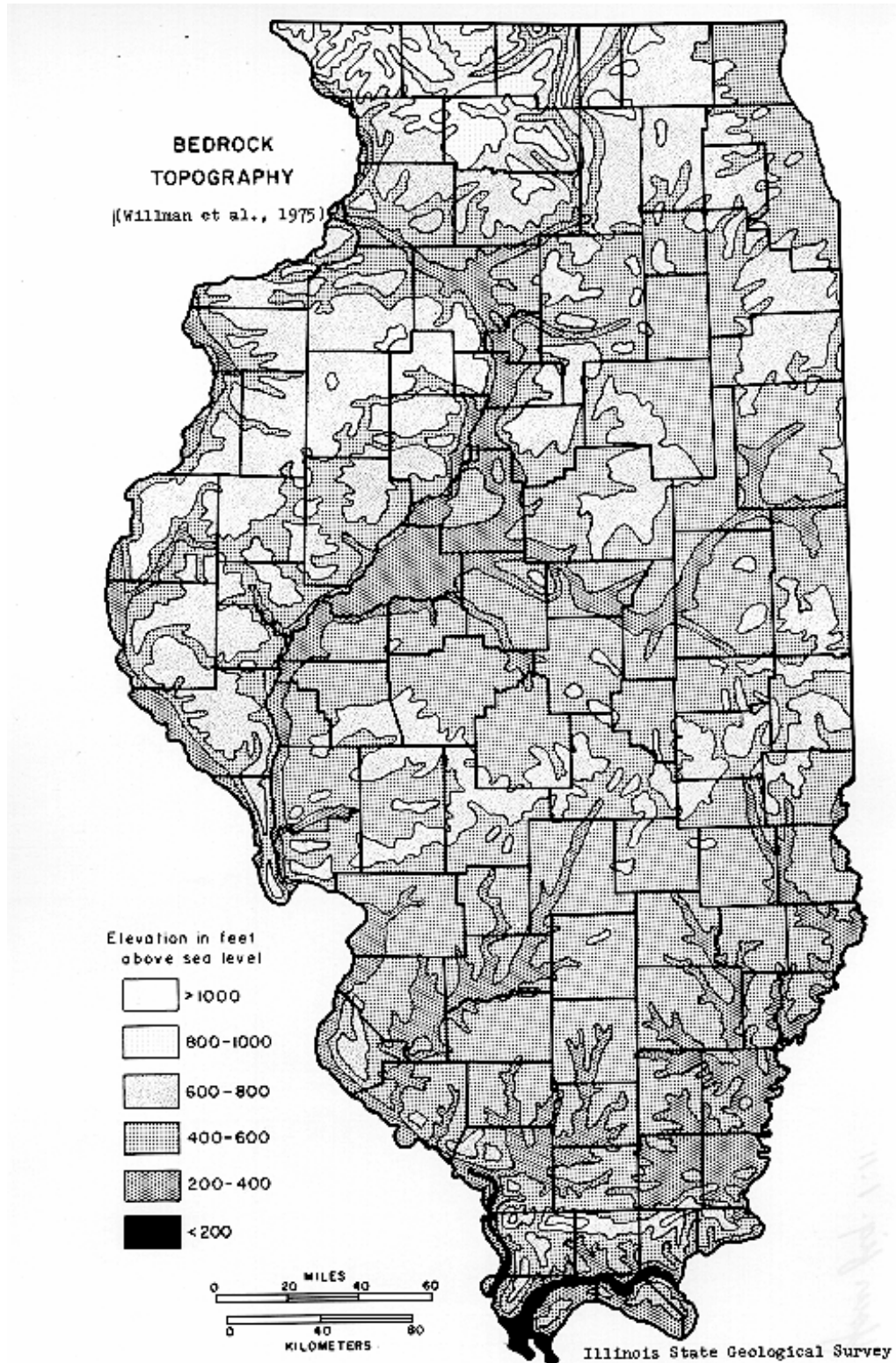

Figure A.10-2 Topography of the Bedrock Surface of Illinois

(From Illinois State Geological Survey – Bulletin 94)

A.11 Bedrock Deposits

Bedrock outcrops are widely distributed throughout Illinois, exceptions to this are: extreme northeastern Illinois; east-central Illinois; the Green River Lowland; the Cache Valley, south of the Shawnee Hills; the floodplains of the Mississippi, Ohio, Wabash and lower Illinois Rivers. In the northwest, west, southwest, and south portions of the State, bedrock is frequently close to the ground surface and can be an important factor in highway design. Even in these latter areas, some of which are unglaciated, rock land surfaces are rare. Except on steep slopes, the surface deposits are unconsolidated.

Excluding some thin igneous dikes and sills (in Gallatin, Hardin, Pope, Saline, and Williamson Counties), the exposed bedrock in Illinois is sedimentary strata. In order of abundance, these strata include: shale, limestone and dolomite, sandstone, and coal. [Figure A.3-1](#) shows the areal distribution of strata by geologic age. [Table A.3-1](#) shows the vertical relationship, character, and thickness of the principal bedrock formations of Illinois. The Geologic Map of Illinois, 1967 edition, and reports on specific areas should be consulted for a more detailed mapping and listing of strata.

The character of a sedimentary rock unit is influenced by source area, depositional agent and environment, and subsequent geologic history; including lithification, possible alteration, and weathering. Frequently, the latter factor is of major concern in highway engineering. A highly generalized description of the main sedimentary rock types of Illinois, and common engineering geology aspects is presented below.

A.11.1 Shale

Shales are compacted and cemented muds composed, primarily, of clay minerals and lesser amounts of silt-sized particles. Many shale units are laminated, others are thick-bedded or massive. There are many varieties of shale which includes the thick, massive Maquoketa Shale; and the fissile (very thin-bedded) black shales of the Pennsylvanian.

Shales weather readily, and they are usually buried under their own debris. Shales rarely crop out, except on very steep slopes or cliffs, where erosion is active. The product of their weathering is a soil which varies with the original composition. A gummy plastic and impervious clay, with a

varying silt content, is common. This material has a tendency to absorb water and to flow downslope.

Shale may be an acceptable subgrade and foundation material, if graded to prevent water from ponding in the immediate area. Slides in shales are common. In shale cuts where the strata dips towards the road, the toe of the slope should be set back. This allows space for the accumulation and removal of slide debris. Deep cuts in shale should be benched at intervals, to prevent excessive sheet erosion. The benches should provide adequate maneuver area, for debris removal equipment, and should be well-drained.

Underclay, a grayish massive indurated clay, is frequently present in the Pennsylvanian section and is a variety of shale. Underclays will occur in a position directly beneath a coal bed. However, in western and northern Illinois, especially in the lower Pennsylvanian; the coals may be absent. A few thin, local coal beds do not have underclays. When wetted, underclays become plastic and are subject to flowage.

A.11.2 Limestones and Dolomites

These two rock types are carbonate rocks and originated as accumulations of limey mud and shell materials, deposited under varying conditions, by various agents. Most **dolomites** appear to have been formed by the replacement of calcite, which is the major mineral constituent of limestone. Chert is a common accessory mineral in both rock types. In addition, and in very limited areas of the State, both limestone and dolomite are replaced by zinc and lead ores, and fluorspar, as well as chert.

The residual soils developed in areas of limestone and dolomite bedrock reflect the impurities in the parent rock. During weathering, the carbonate material is removed in solution. Usually, such insoluble impurities are clay and chert, with some silt and sand. The most common type of soil is a well-drained, yellow to red clayey soil, called residuum; with a blocky structure, and containing angular chert fragments. The soil structure is destroyed on reworking. The resulting, compacted material is frequently plastic and impervious.

In highway engineering, these rock types are of major interest for two reasons. First, they are a major source of aggregate and road material. Second, they are susceptible to solution. The second item is of special concern. As carbonic acid (formed by the combination of water and

carbon dioxide) circulates through a limestone or dolomite rock, it dissolves the carbonate material and carries it away in the underground drainage system. Such solution is, obviously, most intense along the joints and bedding planes of the rock unit. Features resulting from this solution activity include: widened joints, caves and other openings, sinkholes, a highly irregular bedrock surface, rubble filled collapse zones, and “floating” ledges of solid rock embedded in a residual clay. In areas where the solution has been extensive, **karst topography** frequently forms. Such an area is characterized by numerous sinkholes and solution valleys, a lack of surface streams, presence of springs and, usually, an underground drainage system developed in a network of solution cavities. Karst topography is frequently developed in the area where the Middle Mississippian limestones crop out from southern Calhoun County, through Monroe County, to Jackson County, and east to the Cave-In-Rock area. In addition, a buried karst area (developed in Silurian dolomites) is present in the Joliet area.

Engineering geology problems in karst areas include: determination of the irregular bedrock surface, and the presence of underground cavities. Bedrock data from foundation borings, in karst areas, should be carefully interpreted. In addition, “proof-drilling” or core drilling should be considered, to determine that a sufficient thickness of intact rock is present below spread footings. If relatively deep rock cuts are planned in a karst area, the possibility of encountering solution openings and/or rubble filled collapse zones should be considered. The presence of these features can have an important influence on cut slope stability.

The handling of sinkholes along a new alignment should also be carefully considered. Usually, in karst areas, a sinkhole has the important role of collecting and funneling surface runoff into the subterranean drainage system. Stripping of the topsoil and its vegetation cover may expose a subsoil which, during a rainstorm, could erode and plug a sinkhole. If an embankment is to be constructed over a sinkhole, the latter should be securely plugged. If continued drainage is desired, an inverted filter should be constructed in the sinkhole to prevent loss of fines and settlement of the overlying fill.

Generally, limestone is a good subgrade and foundation material, except when solution features occur.

A.11.3 Sandstone

Sandstones are composed mostly of cemented sand-sized grains of quartz, the most chemically resistant mineral. They are usually the most erosion resistant rock in Illinois. Prominent cliffs are formed in sandstones, where the Chester and Lower Pennsylvanian (M & P1, [Figure A.3-1](#)) crop out, in southern and southwestern Illinois.

The cementing material in sandstones may be calcium carbonate, silica, or iron oxides. The resistance of the sandstone to weathering and the resulting soil depends mainly on the character of the cement. Weakly cemented sandstones form sandy soils. Firmly cemented sandstones form silty and sandy clay soils. Shaley sandstones, which are common in the central part of the State (P2 and P3, [Figure A.3-1](#)), weather to clayey soils.

Generally, sandstones are competent subgrades and foundation materials. Rock excavation and seepage into cuts are the principal engineering problems. Occasionally, the upper part of a sandstone unit may become extremely hard due to “case hardening” (additional secondary cementing by iron oxides). This development can give rise to an unwarranted interpretation of the competency of the entire rock unit, if only shallow rock borings are taken.

A.11.4 Coal

There are more than 40 coal seams in Illinois, of which about 20 have been mined commercially. A maximum coal thickness of 14 ft. (4 m) is known. Currently, mined coal will range from 2 to 10 ft. (0.6 to 3 m) in thickness.

All minable coals in Illinois are found in rocks of Pennsylvanian episode. Principally, mined coals include the Colchester (No. 2); Springfield (No. 5); and Herrin (No. 6) coals, in the Carbondale Formation; and Danville (No. 7) coals, in the Shelburn Formation. These coals, as with other Pennsylvanian rocks, occur in repeating series of alternating rock types called cyclothem.

A.11.5 Interbedded Sedimentary Rocks

Sedimentary deposits reflect not only the environment of deposition, but also the composition, relief, and climate of the source area. As these conditions are not always static, the character of a sedimentary section changes both horizontally and vertically. Bedding planes and other

discontinuities, and varying lithologies reflect these changes. Pure limestones grade laterally into shaley limestones, and then into shales, for example. These variations are most pronounced in the Pennsylvanian and in the Chesterian Series of the Mississippian.

The lateral and vertical variation of the character of sedimentary rocks has an important influence on the behavior and stability of the slopes in rock cuts. The greater the number of different rock units present, the greater the divergence from a uniform condition. Permeability and resistance to weathering and erosion are two important factors to be considered. The presence of a permeable sandstone or creviced limestone overlying an impermeable shale, in a cut, could result in excessive seepages and springs along a back slope. If the same rock sequence was inclined into a cut, the buildup of groundwater on top of the shale could decrease the shearing resistance at the contact, to the point that rock slides might develop. As noted earlier, shales frequently weather quite rapidly. If, in a cut, a shale is overlain by more competent strata; such as, sandstone or limestone, the weathering and subsequent erosion of the shale may undercut the more resistant overlying rock units, and rockfalls may result. Remedial or preventive methods usually involve benching on top of shale units. Such benches should be well-drained, possibly even paved. Preventing water from coming into contact with an exposed shale should be a major concern during design.

A.11.6 Mined-Out Areas

In many areas throughout the State: coal, limestone and dolomite, shale and clay, lead and zinc, and fluorspar have been mined. Mining has been both underground and open-pit (strip) mining. The stability of the ground surface over an underground mine is of interest in highway engineering. In addition to knowing the extent of surface mines, pits, and quarries, the engineer is also interested in the waste products or spoil banks of these workings. The waste from coal strip mining is the most extensive in the State.

Subsidence of the ground surface, due to mine collapse, has developed over both longwall and room-and-pillar coal mines in the Pennsylvanian strata. Numerous cases of subsidence are on record. Most subsidence is nearly contemporaneous with extraction, but some occurs much later. Mine collapse results from both roof failure and pillar failure, due to outward squeezing of the underclay beneath the pillars.

Mine operators are required by law to submit an annual, up-to-date map of their operations to the County Recorder, but many of the early mines antedated the law and are uncharted. Most of these early mines are near the outcrop of the principal coal seams.

The Illinois State Geological Survey periodically prepares regional “Mined-Out Maps”, copies of which can be obtained from the Survey. Strip mines for coal presently go as deep as 100 ft., to mine 6 ft. of coal or less. The Illinois State Geological Survey has undertaken a study of the “Strippable Coal Reserves of Illinois.” Maps included in the various regional reports of this study indicate: coal outcrops, thickness of coal, overburden thickness, and mined-out areas.

The lead and zinc mines of Jo Daviess County and southwestern Wisconsin have two records of subsidence. In November 1972, a hillside on the Ed Bautsch farm collapsed. An area 300 by 700 ft. (91 by 213 m) subsided about 150 ft. (46 m). Fifty years earlier a similar subsidence occurred over the Kennedy Mine, across the state line in Wisconsin.

In southeastern Illinois, the history of subsidence over fluorspar operations varies. The underground workings of the blanket “Spar”, of the Cave-In-Rock area, are in competent beds of sandstone and limestone, and no subsidence is anticipated. In the Rosiclare- Eichorn areas, near surface underground workings have caused some subsidence. In both fluorspar areas, exploration pits and open trench mines have been poorly filled, and subsidence over these can be expected. Thus, it is important to locate old mines and exploration pits.

Other old, and generally abandoned, underground mines were formerly worked to obtain shale and clay (for bricks, pottery, and other ceramic items). The major deposit involved was the Pennsylvanian Cheltenham Clay (P1, [Figure A.3-1](#)). This unit was mined in western and southern Illinois, and in LaSalle County along the outcrop of the Spoon Formation. With regards to mine collapse and surface subsidence, clay and shale mines probably behave similar to coal mines.

Surface subsidence over an underground limestone mine (in the form of steep sided sinks) is evident near Oglesby, in LaSalle County.

A heavy concentration of oil and gas wells exists in parts of southern Illinois. The liquids and gases removed from sedimentary strata, do not leave large cavities. However, removal of liquids and gases reduces the pore pressures in the porous rock, and it may result in subsidence at the surface. In general, the rate of subsidence is slow, and the bowl of depression is large. The

settlements are apparent only after long time intervals. Nevertheless, such subsidence may have design implications.

A.12 Structural Geology and Seismic Activity

As indicated on the “Geologic Map of Illinois”, 1967 edition, the bedrock of Illinois has been deformed by a series of structural features. Foremost of these would be the Illinois Basin, a statewide downwarping of Paleozoic strata, and its flanking Ozark Dome, and Mississippi River and Kankakee Arches. Superimposed on these large scale features are smaller scaled folds and faults; which includes the LaSalle and Waterloo Anticlines, and the Gap-Au-Gres Flexure Zone. Also included are the following fault zones: Sandwich, Plum River, Cottege Grove-Shawneetown, and Wabash Valley.

The New Madrid Fault Zone is located in northeastern Arkansas and southeastern Missouri (the “Bootheel”). To date, it is believed that the New Madrid Fault Zone does not continue into the bedrock of Illinois. It should be emphasized that all of these fault zones are zones. The past movements have occurred on multiple fault planes. Furthermore, to date, no ground surface displacement has been attributed to any historical earthquake in Illinois. None of these zones, with the exception of the New Madrid Fault Zone, and possibly, the Wabash Valley Fault Zone would be considered “active” today.

The seismic history of Illinois, and the driving force behind the need to consider the application of seismic design factors in present designs, is dominated by the so-called “New Madrid Earthquakes” of 1811-1812. Beginning in December of 1811, and continuing at least into February of 1812, the Mid-Continent area of the Missouri Bootheel and northeastern Arkansas, and adjacent southern Illinois, and western Kentucky and Tennessee were hit by a series of damaging earthquakes. It is now recognized that among the series of hundreds of individual tremblers, three main events can be identified. These three shocks have been characterized as, probably, the largest magnitude earthquakes ever to occur in the continental 48 states.

The earthquake motion was felt from the Denver, Colorado area to the East Coast. Obviously, these events predated the introduction of standard seismographs. Thus, only generalized references to Richter magnitude scales can be made. Intensity levels for the major events were determined by the late Professor Otto Nuttli, of Saint Louis University; and indicate levels comparable to that experienced during the San Francisco 1906 Earthquake.

Due to continuing low magnitude (mostly below the threshold of human response) earthquakes, originating in the New Madrid area, the modern seismicity of the mid-continent area has been widely questioned. In the 1950's and '60's, largely in response to seismicity questions arising from nuclear power plant design, numerous geologic and geophysical studies were initiated in the area. Finally, results processed from a micro-seismographic network indicated, for the first time, where subsurface movements were occurring on a previously unknown series of faults in the New Madrid region. Low magnitude (3.0 or less) earthquakes continue to occur in this area on almost a daily basis, demonstrating that the zone has a potential for possible major movements. It is this zone's history and continuing activity, that warrant today's seismic design concerns.

A.13 Pedology

The function of soil survey and soil classification procedures is to furnish adequate information for highway design. The complexities and non-uniformity of soil, as a construction material, require adequate and economical methods to identify and classify soil, and soil deposits. One system which provides a basic approach to soil interpretation, for the design of highways, is the pedological system of classification. The pedological system was developed primarily for agricultural purposes, and it is used extensively in the preparation of county soil maps and reports. The pedological system, in addition to information and data pertaining to engineering properties, is a valuable classification for highway use.

The pedological system deals with soil as a natural body, and it classifies the soil profile on the basis of natural soil-forming factors: parent material, drainage (topography), climate, vegetation, and age. Wherever these soil forming factors are identical, the soils will be found to be the same. Similarly, wherever the highway subgrade lays in the same horizon of the same pedologic soil, subgrade performance should be the same, regardless of geographic location. This has been demonstrated, by experience, in several states and holds true because texture, water table, frost index, and capillarity are inherently a part of the pedological classification. In addition, the system permits the delineation of boundaries and identifies soil units (series) within these boundaries, thereby, giving the soil classification a real significance. Furthermore, when samples are taken for laboratory testing, they also can be selected as representative of certain profiles. The greatest benefits are obtained when soil index properties, construction problems, and field performance can be correlated directly with the pedologic classification. The time to acquire all of this information requires many years of observations, but some data is presently available. This information is compiled and updated in the form of County Soil Survey Reports (see [Section](#)

[3.2.2.3.2](#)). Estimates of field performance can often be made on the basis of soil profile characteristics, and a general knowledge of the behavior of pavements on various kinds of soil materials. Since highway soil engineering, in Illinois, could benefit greatly by the use of the pedological system, the following sections describe its characteristics.

A.14 The Soil Profile

Immediately after the deposition of material by any geologic process, the forces of chemical and physical weathering begin to attack it. These forces are most effective in altering the material exposed at the surface. Weathering leads to the development of layers or **horizons** of material, in varying episodes of alteration. The total of all these horizons exposed in a cut or section, at any particular location, constitutes the **profile of soil weathering**, the **pedologic soil profile**, or simply the **soil profile**. The engineer should bear in mind that this soil profile is not, in most cases, synonymous with the usual conception of a soil profile. The latter may extend from the surface, to considerable depths, through all unconsolidated material above bedrock. Thus, the engineer's profile will usually include horizons which are due to deposits, as well as those produced by weathering. If several deposits extend close to the ground surface, it may be difficult to distinguish between the character of the horizon as deposited, and the alterations which have taken place due to weathering from the surface downward.

A hypothetical pedologic soil profile is shown in [Table A.14-1](#). The profile contains three principal or major horizons, designated as **A**, **B**, and **C**. The uppermost horizons are often further subdivided on the basis of minor variations occurring in the zones, which are transitional from one horizon to the other. It is extremely unlikely that any particular soil profile would show all of the horizons, as shown in [Table A.14-1](#). From the engineering standpoint, it is usually sufficient to deal only with the principal horizons. In humid regions, the uppermost horizon, **A**, has been subjected to the most rigorous attack. Consequently, it normally contains relatively small amounts of soluble constituents and clay-size particles. On the other hand, it is usually the highest in organic matter content.

The leached or eluviated **A** horizon gradually changes, at its base, into the second horizon, **B**, in which fine grained material has been deposited. The deposition or illuviation process has joined together fine particles into larger particles or aggregates. This aggregation usually results in the development of a structural arrangement of visible fragments, which are often characteristic of

the various conditions of soil formation. Such structural development is nearly always lacking in the horizons below the **B**.

Generally, there is a gradual change from the **B** horizon into the relatively unaltered material, which is representative of the original deposit. Depending upon the normal position of the groundwater table, some leaching of soluble constituents or oxidation of the iron compounds may have taken place in the upper part of this third, **C**, horizon. Usually, however, the material will be texturally similar to the original deposit and relatively unaltered from the engineering standpoint. It has been previously mentioned, that the surface deposits in a large part of Illinois consist of a layer of loess, underlain by glacial drift. Consequently, many Illinois soils have a **C** horizon composed of relatively unaltered loess, which is underlain at variable depth by a horizon of glacial drift. This underlying horizon would be designated as **IIC**. If part of the **B** horizon extended into the glacial drift, the lower **B** would be properly designated as **IIB**.

Soil profiles are classified according to their characteristics, both internal and external, and they are grouped on the basis of these characteristics into mapping units. A mapping unit commonly includes a series, type, and phase designation. Areas that have no true soil profile; such as lake beaches, rock outcrops, or mine dumps are usually designated as ***miscellaneous land types***.

HORIZONS*		DESCRIPTIONS	
O ₁	Undecomposed organic debris.	L. † Loose leaves.	
O ₂	Partly decomposed organic debris.	F. † Organic structure evident. H. † Amorphous humus.	
A ₁	A dark colored horizon with a relatively high content of organic matter mixed with mineral matter.	A. Zone of eluviation. Darker in color and/or lower in clay content than the underlying horizon.	Solum
A ₂	A light colored horizon where maximum eluviation and leaching have occurred.		
A ₃	Transition to underlying horizon but more like A.		
B ₁	Transition from overlying horizon but more like B.	B. Zone of illuviation. A zone of structural development underlying the A horizon.	
B ₂	Horizon with greatest clay content and/or greatest structural development.		
B ₃	Transition to underlying layer but more like B.		
C ₁	Slightly altered material. Soluble salts may be precipitated in this horizon in arid climates.	C. Does not show soil structure but will have structure of parent rock.	
C ₂	Relatively unweathered material.		
R	Underlying consolidated bedrock.		

† Terminology used by foresters.
 * Roman numerals (II, etc.) are prefixed to the appropriate horizon designations to indicate successive layers of contrasting material from the surface downward.

Table A.14-1 A Hypothetical Soil Profile Showing Its Major Characteristics

In describing the typical soil profile, the following features are considered:

- Number of horizons in the profile.
- Thickness of horizons in the profile.
- Relative arrangement of horizons in the profile.
- Percent organic matter, usually reflected in the color of the horizon.
- Drainage class, as influenced by surface slope, permeability of soil, and position of water table. The water table is usually reflected in the brightness of color, and presence or absence of mottling.
- Texture and structure of horizons.
- Chemical and mineralogical composition.
- Concretions and other special formations.
- Vegetation.
- Geology of the parent material.

A.15 Pedologic Classification and Mapping Units

A.15.1 Soil Series

The most important unit of soil classification is the **soil series**. A soil series includes all soil profiles, which are essentially similar with regard to the features listed previously. Thus, the series includes soils having essentially the same color, structure, and other important internal characteristics; and the same natural drainage conditions, and range in relief. The soil series, usually, derives its name from a geographic feature near where it was first identified. Thus: Drummer, Miami, and Tama are common names of soil series in Illinois. When the soil series is used as a mapping unit, on county soil maps, the boundaries do not, necessarily, enclose an area in which all of the soil profiles have the characteristics of the series. However, at least 85% of the area enclosed should have those characteristics.

A.15.2 Soil Type

A given series may be subdivided into one or more **soil types**, which are defined according to the texture of the upper portion (**A** horizon) of the soil. Thus, the class name of the soil texture; such as, sand, loam, silt loam, or clay is added to the series name, to give the complete name of the soil type. The textural characteristics of all horizons are based upon a classification system

adopted by the USDA/NRCS, which differs slightly from those commonly used in highway engineering work. [Figure A.5.1-1](#) shows the textural classification diagram and the size ranges of each of the soil separates (which are used for classifying soils in all pedologic publications). In modern Illinois County Soil Reports, the use of soil series and type names is practically synonymous. That is, very few series include more than one type. The same comments about the use of soil type as a mapping unit apply, as noted under soil series.

A.15.3 Soil Phase

A **phase** of a soil type is a variation which differs from the basic soil type, in a minor surface characteristic, that has practical significance. The degree of stoniness or slope are examples of such subgroups.

A.15.4 Soil Association

As a result of variations in local relief, drainage, solum texture, and color; one particular soil series usually covers only a rather limited contiguous area of the earth's surface. Normally, several series which were developed at the same time, from similar parent material, under similar natural vegetation are intermingled. Thus, when pedologic maps are prepared, it is found that a few major series, and perhaps, several minor series are associated in a pattern that is distinctive, although not entirely uniform. The group of soils that occurs in such a characteristic pattern is called a **soil association**, and it is named for the major series included. Sidell-Catlin-Flanagan-Drummer, Hoyleton-Cisne-Huey, and Seaton- Fayette-Stronghurst are typical associations in Illinois. For most associations, the significant difference in a series is topography. Therefore, a fairly accurate detailed pedologic map may be prepared from a soil association map; by knowing the soil series, topography relationships, and a study of the topography of an area. Aerial photographs, especially those providing stereo coverage, provide a convenient means of mapping a soil series within a given association. Unfortunately, the number of published association maps is small. However, when soil association maps are available, they provide a means of updating soil maps, and making maps when no detailed pedologic maps are available. [Figure A.15.4-1](#) is a general soil association map of Illinois, provided by the University of Illinois Agricultural Experiment Station. The original publication contains a larger scale map, in color.

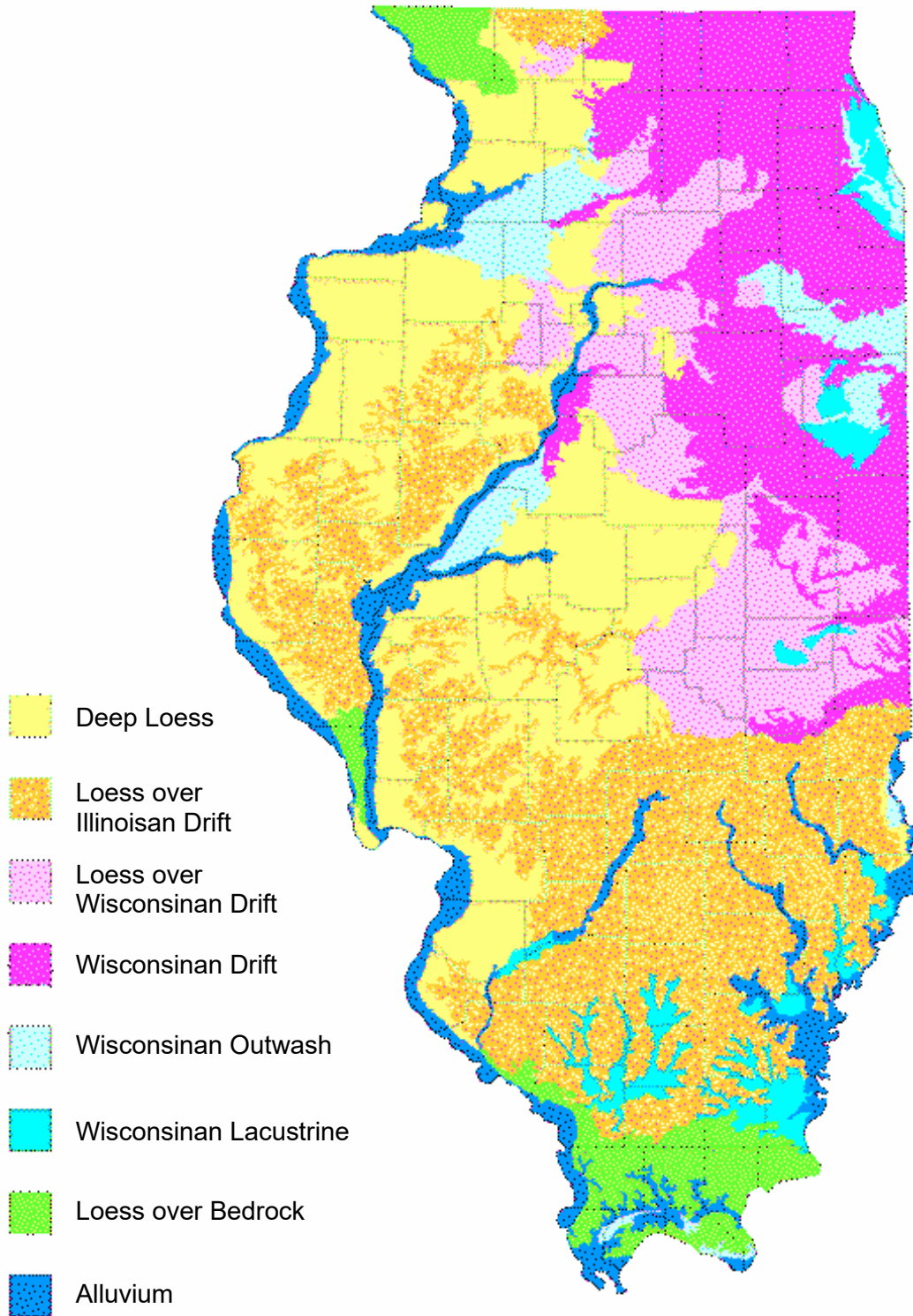

Figure A.15.4-1 Generalized Soil Map of Illinois
(Compiled and prepared by the USDA NRCS)

Appendix B Laboratory Test and Mix Design Procedures

B.1 Laboratory Test and Mix Design Procedures

This appendix contains the following laboratory testing and mix design procedures:

- [B.2 Method of Determining the IBR and the IBV of Soils, Treated Soils, and Aggregates](#)
- [B.3 Soil Modification with Various Materials: Laboratory Evaluation/Design Procedure](#)
- [B.4 Lime Stabilized Soil Mixtures: Laboratory Evaluation/Design Procedure](#)
- [B.5 Soil-Cement Mixture: Laboratory Evaluation/Design Procedures](#)
- [B.6 Cement-Aggregate Mixture: Laboratory Evaluation/ Design Procedures](#)
- [B.7 Pozzolanic-Stabilized Mixture: Laboratory Evaluation/Design Procedure](#)

Geotechnical Manual

Appendix B Laboratory Testing and Mix Design Procedures

B.2 Method of Determining the IBR and the IBV of Soils, Treated Soils, and Aggregates

B.2.1 IBR Test

B.2.1.1 Scope

- (a) This test method is for determining the Illinois bearing ratio (IBR) of treated or untreated base, subbase, and subgrade materials; prepared at the OMC and SDD, and soaked in water for four days. The IBR, thus obtained, will primarily be used for pavement design. The IBR is the same as the CBR, determined according to AASHTO T 193, except for the slight modifications described herein for the IBR test. Since the IBR is assumed to have the same numerical value as the CBR for design purposes, AASHTO T 193 may be used in lieu of the IBR test.
- (b) This test method is also for determining the extent to which materials will expand or swell during a four-day soaking period.

B.2.1.2 Equipment

Equipment shall meet the requirements of AASHTO T 193, except that sub-section 4.8 shall be replaced by the following:

Loading Device - A compression type equipment capable of applying a uniformly increasing load, up to 60,000 lb. (267 kN), at a constant rate of 0.05 inches (1.27 mm) per minute (see Note 1). This loading device is to be used for compacting the entire material within the mold in one layer and is to be used for the penetration test.

Note 1: Some soils may require greater than 60,000 lb. (267 kN) load to fully compact the sample.

Geotechnical Manual

Appendix B Laboratory Testing and Mix Design Procedures

B.2.1.3 Sample

Sample preparation shall be according to AASHTO T 193 and T 224, if applicable, with the following modification:

- (a) Duplicate test specimens are required (see Note 2).

Note 2: Two test specimens are necessary to determine whether an individual specimen is being unduly influenced by the arrangement of the coarser particles or by unequal moisture distribution.

B.2.1.4 Procedure

The procedure shall be according to AASHTO T 193, except that Section 7.1.4 shall be replaced by the following:

- (a) Determine the mass of dry soil or material and the amount of water required to make a compacted sample at the OMC and SDD, previously determined according to Illinois Modified AASHTO T 99 (Method C). Thoroughly mix the soil and water until a homogeneous mixture is obtained.
- (b) Place the moist soil or material into the mold, tamping lightly, if necessary, (a piece of wax paper on the solid base plate will prevent the material from adhering to the metal plate). Place a solid steel plate [1 inch (25.4 mm) minimum thickness and 5.95 inches (151 mm) diameter] into the compaction mold using the loading device. The sample shall then be compacted (pressed) in one layer. During the final 1/2 inch (12.7 mm) of compaction, the head of the loading device shall be operated at the rate of 0.05 inches (1.27 mm) per minute. The load shall be held for 1 minute and then released slowly.
- (c) The height of the compacted specimen shall be measured and recorded, and the assembly and specimen shall be weighed. The mass of specimen shall be recorded as the compacted mass of specimen.

Geotechnical Manual

Appendix B Laboratory Testing and Mix Design Procedures

B.2.1.5 Soaking

Prior to the penetration test, the sample shall be soaked according to AASHTO T 193.

B.2.1.6 Penetration Test

Penetration test shall be according to AASHTO T 193.

B.2.1.7 Calculations

The IBR shall be calculated according to AASHTO T 193, except that the IBR at 0.2 inches (5 mm) penetration shall be reported.

B.2.1.8 Report

Report requirements shall be according to AASHTO T 193, except that the compactive effort need not be reported and that the following data shall also be recorded and reported for each of the samples tested:

- (a) OMC (%), as determined according to Illinois Modified AASHTO T 99, Method C.
- (b) SDD [pcf (kg/m³)], as determined according to Illinois Modified AASHTO T 99, Method C.
- (c) The IBR (%) to the nearest tenth on values below 10, and to the nearest whole number for values above 10.

Geotechnical Manual

Appendix B Laboratory Testing and Mix Design Procedures

B.2.2 IBV Testing

B.2.2.1 Scope

This test method is for determining the immediate bearing value (IBV) of treated or untreated subgrade materials prepared at a range of moisture contents. For untreated soil, the test is conducted immediately after compacting the material, according to Illinois Modified AASHTO T 99, without soaking in water. For modified soils, the test is conducted 24 hours after compaction to allow for curing, without soaking in water. The IBV, thus obtained, will primarily be used for determining the subgrade stability under construction traffic, the need for subgrade treatment and the depth of treatment.

B.2.2.2 Equipment

Equipment shall meet the requirements of:

- (a) Illinois Modified AASHTO T 99 (Method C or D, depending on the soil type as defined in [Appendix B.2.2.3](#) below).
- (b) Penetration piston and loading device meeting the requirements of AASHTO T 193.
- (c) Dynamic cone penetrometer (DCP) that conforms closely to that diagramed in [Figure 4.7.2.1-1](#).

B.2.2.3 Sample

Type 1 Soils - Soils with > 10% clay (and < 90% silt* and/or sand*)* - Samples shall be prepared according to AASHTO R 58 and Illinois Modified AASHTO T 99 [Method C or D, using 100 mm (4 inch) or 150 mm (6 inch) diameter mold].

Type 2 Soils - Soils with < 10% clay (and > 90% silt* and/or sand*)* - Samples shall be prepared according to AASHTO R 58 and Illinois Modified AASHTO T 99 [Method D, using 6 inch (150 mm) diameter mold].

Geotechnical Manual

Appendix B Laboratory Testing and Mix Design Procedures

* Determined according to AASHTO T 88.

B.2.2.4 Procedure

- (a) Compaction - Samples shall be compacted according to Illinois Modified AASHTO T 99 (Method C or D, depending on the soil type as defined in B.2.2.3 above) at the OMC, or at a specified field moisture content. Modified soils shall be mellowed according to [Appendix B.3.4 \(e\)\(2\)](#) prior to compaction.
- (b) Curing – After compaction, and prior to IBV testing, modified soil shall be cured according to [Appendix B.3.4 \(g\)](#).
- (c) Penetration Test – *For Type 1 Soils only* – For untreated soils, penetration test shall be conducted according to AASHTO T 193 on each compacted sample of the moisture-density test, immediately after compaction without soaking in water. For modified soils, the test is conducted 24 hours after compaction to allow for curing, without soaking in water.
- (d) DCP Test – *For Type 1 and 2 Soils* – For untreated soils, DCP test shall be conducted on each compacted sample of the moisture-density test, immediately after compaction without soaking in water. For modified soils, the test is conducted 24 hours after compaction to allow for curing, without soaking in water. The DCP test shall be conducted as follows:
 - i. Seat the DCP cone into the sample such that the zero point coincides with the top of sample. This will require an initial cone penetration of 1 to 2 inches (25 to 50 mm) into the sample, depending on the manufacturer. It will also leave approximately 2.5 to 3.5 inches (60 to 90 mm) of total penetration into the sample, considering the mold height approximately 4.6 inches (117 mm). Seating the sample requires careful tapping into the sample with the hammer, depending on the soil strength.
 - ii. Carefully lift the DCP hammer to the maximum height [22.6 inches (575 mm)] and let it drop freely onto the anvil.

Geotechnical Manual

Appendix B Laboratory Testing and Mix Design Procedures

- iii. After each hammer drop, measure and record the depth of penetration to the nearest 0.1 inch (2.5 mm).
- iv. Terminate the test when 2 to 2.5 inches (50 to 65 mm) of penetration has been achieved. Care must be taken to prevent driving the DCP cone into the base plate.

B.2.2.5 Calculations

Penetration Test - The IBV shall be calculated according to AASHTO T 193.

DCP Test - Determine the average penetration rate [PR, inches (mm)/blow] for the data derived in B.2.2.4(d) above. Using the empirical equations provided in ITP 501, and reflected on form [BMPR SL30](#), determine the equivalent IBV.

B.2.2.6 Report

The following information shall be provided in the report:

- (a) The dry density and the IBV at the OMC, or at a specified field moisture content.

Geotechnical Manual

Appendix B Laboratory Testing and Mix Design Procedures

B.3 Soil Modification with Various Materials: Laboratory Evaluation/Design Procedure

B.3.1 Scope

This method describes the preparation and testing of a modified soil composed of soil, water, and a modifier. The modifier could be Class C fly ash, Type I Portland cement, slag-modified Portland cement (SM cement), by-product hydrated lime, by-product non-hydrated lime (lime kiln dust), or lime slurry. The purpose of this method is to evaluate the properties of the modifier-soil mixture and to recommend a design modifier content for construction.

B.3.2 Equipment

Equipment shall meet the requirements of AASHTO R 58, T 88, T 89, T 90, and Illinois Modified AASHTO T 99 tests, and the IBV Testing in [Appendix B.2.2](#) of this manual.

B.3.3 Samples

Samples of soil and the appropriate modifier shall be provided as follows: 200 pounds of soil and 25 pounds of dry modifier (or 2 gallons of lime slurry). The modifier shall be transported and stored in air-tight container.

B.3.4 Procedures

- (a) Dry Preparation of Soil – The soil, as received, shall be prepared according to AASHTO R 58.
- (b) Particle Size Analysis (optional) – Particle size analysis shall be performed on the untreated soil according to AASHTO T 88.
- (c) Plasticity Testing (optional) – Tests for the liquid limit and the plastic limit of the untreated soil shall be conducted according to AASHTO T 89 and T 90, respectively.

Geotechnical Manual

Appendix B Laboratory Testing and Mix Design Procedures

- (d) Moisture Density Relations – The Standard Dry Density and the Optimum Moisture Content (OMC) of the untreated soil shall be determined according to Illinois Modified AASHTO T 99. The IBV shall be determined according to [Appendix B.2.2](#), using either the penetration test or the DCP test depending on the soil type.
- (e) Soil–Modifier Mixtures
- (1) Proportioning – The modifier shall be added to the untreated soil on a dry weight basis as follows:
- i. Fly ash - Add increments of 5%, not to exceed 20%.
 - ii. Portland cement or SM cement - Add increments of 1%, between 2% and 5%.
 - iii. Lime mixtures - Add increments of 2%, up to 6%.
- (2) Mixing – At each modifier content, dry mix enough soil-modifier mixture for one Illinois Modified AASHTO T 99 compaction point, until a homogeneous mixture is obtained. Gradually add the compaction water. Continue mixing for 2 minutes (Note 1). Place the resulting mixture in a sealed container to minimize moisture loss. Mellow the soil modifier mixture for one hour, except for the by-product, hydrated lime which shall be mellowed for 24 hours before compaction. Prepare a new soil–modifier mixture at the next modifier content and repeat this mixing and mellowing procedure.
- Note 1. The lime slurry shall be thoroughly agitated by shaking to ensure uniform suspension of the solids before mixing with the untreated soil.
- (f) Compaction - Compact the soil–modifier mixture, after the appropriate mellowing time, according to Illinois Modified AASHTO T 99 [Method C or D, using 100 mm (4 inch) or 150 mm (6 inch) mold, depending on the soil type, as defined in [Appendix B.2.2.3](#)].
- (g) Curing - Samples of soil treated at the rates determined in B.3.4(e)(1) above, and compacted at various moisture contents, shall be moist cured inside the mold for 24 hours prior to conducting the IBV test.

Geotechnical Manual

Appendix B Laboratory Testing and Mix Design Procedures

- (h) IBV Testing – Conduct the IBV test, after curing, according to [Appendix B.2.2.4](#) (Note 2).
- (i) Moisture Determination – After curing and the IBV testing, determine the moisture content of each sample according to Illinois Modified AASHTO T 265. Obtain the standard dry density (SDD) and the optimum moisture content (OMC) for the untreated soil and for the treated soil, at each modifier content (Note 2).

Note 2. Repeat the compaction and the IBV testing procedures for each sample, at each modifier content, and each moisture content, until the moisture–density–IBV relationships are obtained for the series of modifier contents.

- (j) Evaluation of Test Results – Plot the dry density and the IBV versus moisture content for the untreated soil and the treated soil at each modifier increment.
- (k) Determination of the Design Modifier Content – The minimum modifier content shall be designated as the percent modifier which provides an IBV of 10 or more at 110% of the OMC. To offset construction loss or uneven distribution, increase the minimum fly ash content by 1%, the minimum Portland cement or SM Portland cement content by ½%, and the minimum lime content by ½ to 1%. This new value is called the design modifier content.

B.3.5 IBR Test (Optional)

The IBR test may be conducted according to [Appendix B.2.1](#), at the design modifier content and the OMC, or at a specified field moisture content, of the treated soil. The amount of swell after soaking in water for four days shall not exceed 4%.

Geotechnical Manual

Appendix B Laboratory Testing and Mix Design Procedures

B.3.6 Report

- (a) Route
- (b) Section
- (c) County
- (d) Job number
- (e) Material identification and source
- (f) AASHTO M 145 classification and group index
- (g) IDH textural classification
- (h) The recommended design modifier content (%)
- (i) Laboratory OMC and SDD (Illinois Modified AASHTO T 99) of the untreated soil and the treated soil at the design modifier content
- (j) Particle size analysis (AASHTO T 88)
- (k) Plasticity Index (AASHTO T 90)
- (l) Plots of dry density and IBV versus moisture content at each modifier content
- (m) Plot of percent modifier versus the IBV at OMC
- (n) Age of test specimens when tested
- (o) The IBR and the amount of swell (if the test is conducted)

Geotechnical Manual

Appendix B Laboratory Testing and Mix Design Procedures

B.4 Lime Stabilized Soil Mixtures: Laboratory Evaluation/Design Procedures

B.4.1 Scope

This method describes the preparation and testing of lime-soil mixtures for the purpose of recommending a design lime content for stabilization. This method can also be used for evaluating the properties of the lime-soil mixtures. In this method, the SDD and the OMC of the untreated soil and the soil-lime mixtures at different lime contents are to be determined. The lime content is designated as a percentage, by mass of the oven dry soil. The soil-lime mixtures are to be proportioned within the limits of 3 to 8% lime content. The unconfined compressive strength is to be determined at the OMC, or at a specified field moisture, for the untreated soil and for each mixture. The design lime content that meets the strength criteria, stipulated in this method for lime stabilized soil mixtures, is to be determined.

B.4.2 Equipment

- (a) Specimen Mold Assembly - Mold cylinders 2 inches (51 mm) in diameter by 4 inches (102 mm) in height, base plates, and extension collars shall conform to the details shown in [Figure B.4.2-1](#).
- (b) Compaction Hammer - The compaction hammer ([Figure B.4.2-2](#)) shall have a flat, circular tamping face; and a 4 lb. (1.81 kg) sliding mass, with a free fall of 12 inches (305 mm).
- (c) Sample Extruder - A jack, lever frame, or other suitable device adapted for the purpose of extruding compacted specimen from the specimen mold ([Figure B.4.2-3](#)).
- (d) Balance or scale - Minimum 5 kg (10 lb.) capacity, sensitive to 0.1 g.
- (e) Oven - Thermostatically controlled, capable of maintaining temperatures at $120^{\circ} \pm 4^{\circ}$ F ($49^{\circ} \pm 2^{\circ}$ C), and at $230^{\circ} \pm 9^{\circ}$ F ($110 \pm 5^{\circ}$ C).
- (f) Curing Containers - The curing containers shall be capable of maintaining a positive moisture seal, as the specimens are to cure at the molding moisture content.

Geotechnical Manual
Appendix B Laboratory Testing and Mix Design Procedures

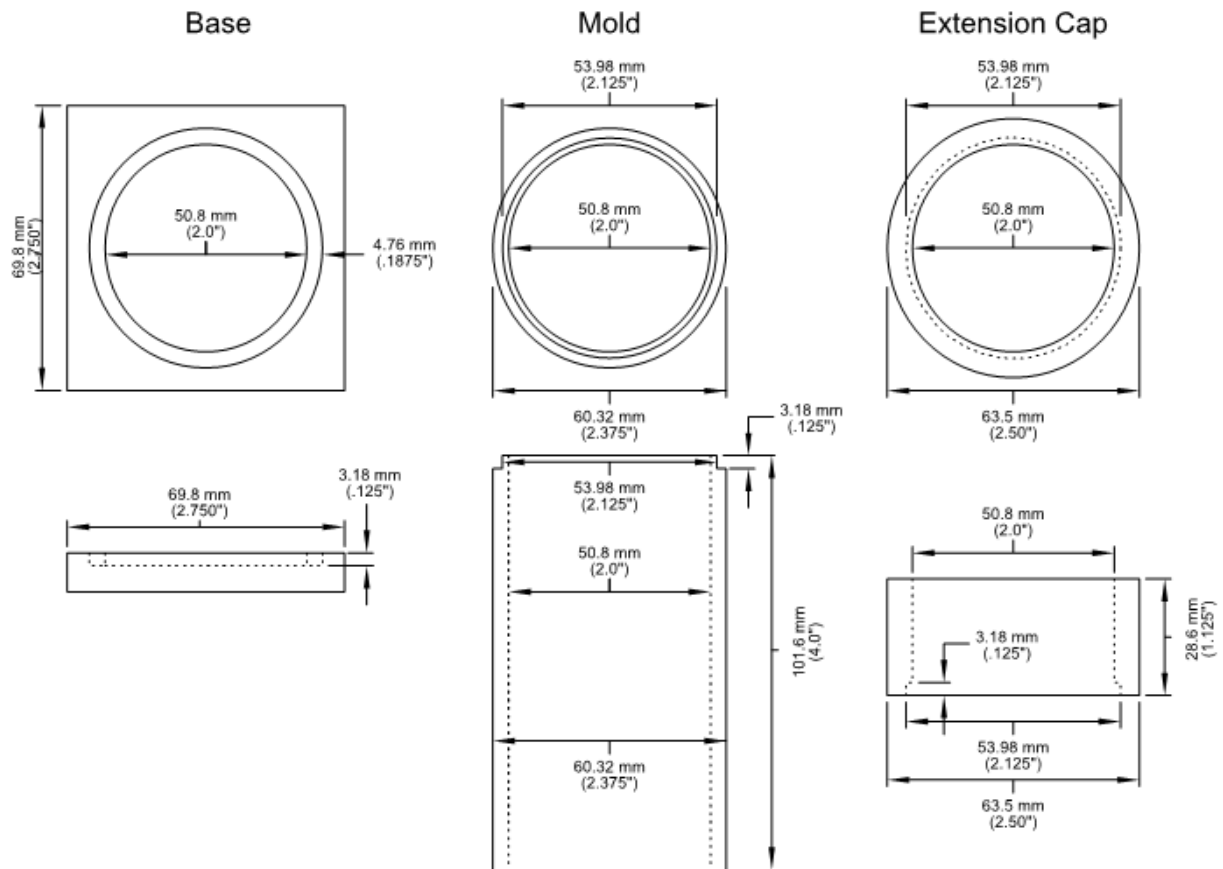

Figure B.4.2-1 Specimen Mold Assembly

- (g) Compression Device - The compression device may be of any type, which maintains a minimum capacity of 2,000 lb. (8.9 kN). The load shall be applied continuously, and without shock. The moving head shall travel at a constant rate of 0.05 inches (1.27 mm) per minute.
- (h) Miscellaneous Equipment - Equipment necessary to accomplish AASHTO R 58, T 88, T 90, and Illinois Modified AASHTO T 99: scarifier, trimming and carving tools, moisture content cans, and data sheets, as required.

Geotechnical Manual
Appendix B Laboratory Testing and Mix Design Procedures

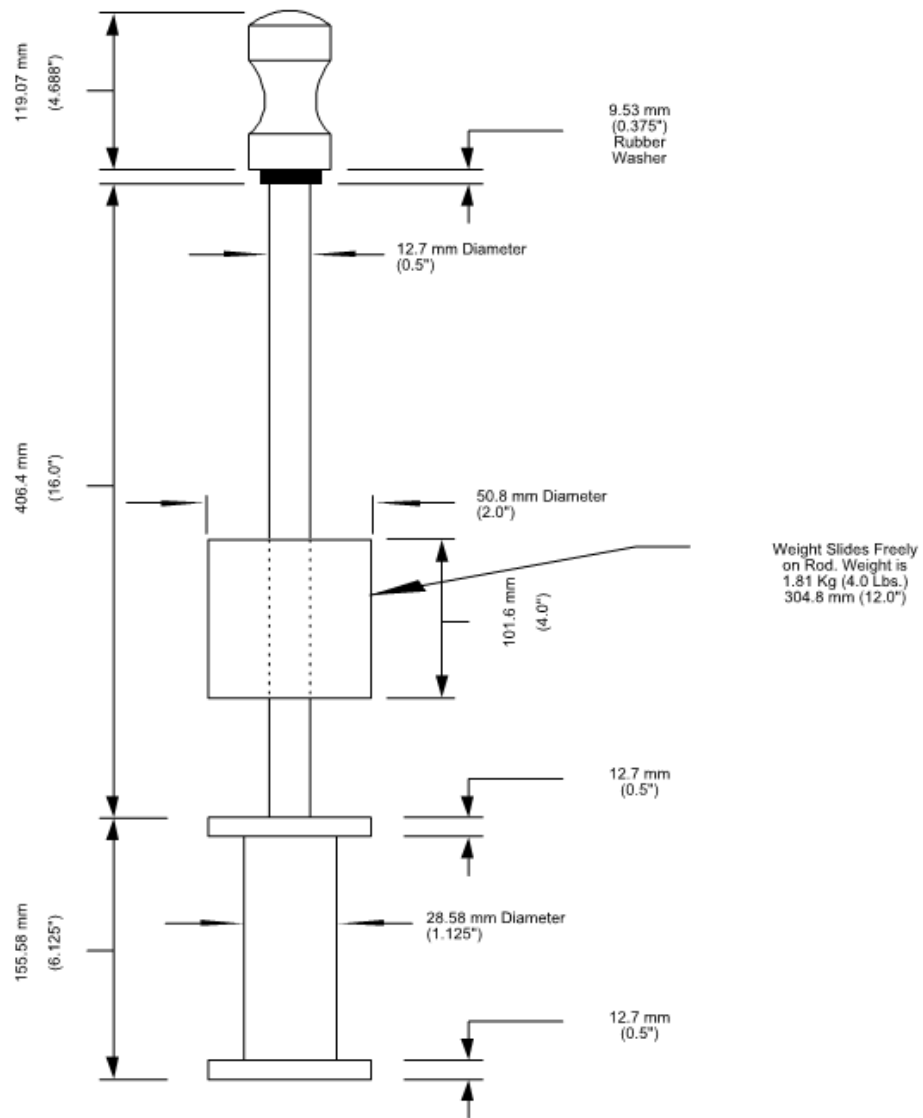

Figure B.4.2-2 Compaction Hammer

Geotechnical Manual
Appendix B Laboratory Testing and Mix Design Procedures

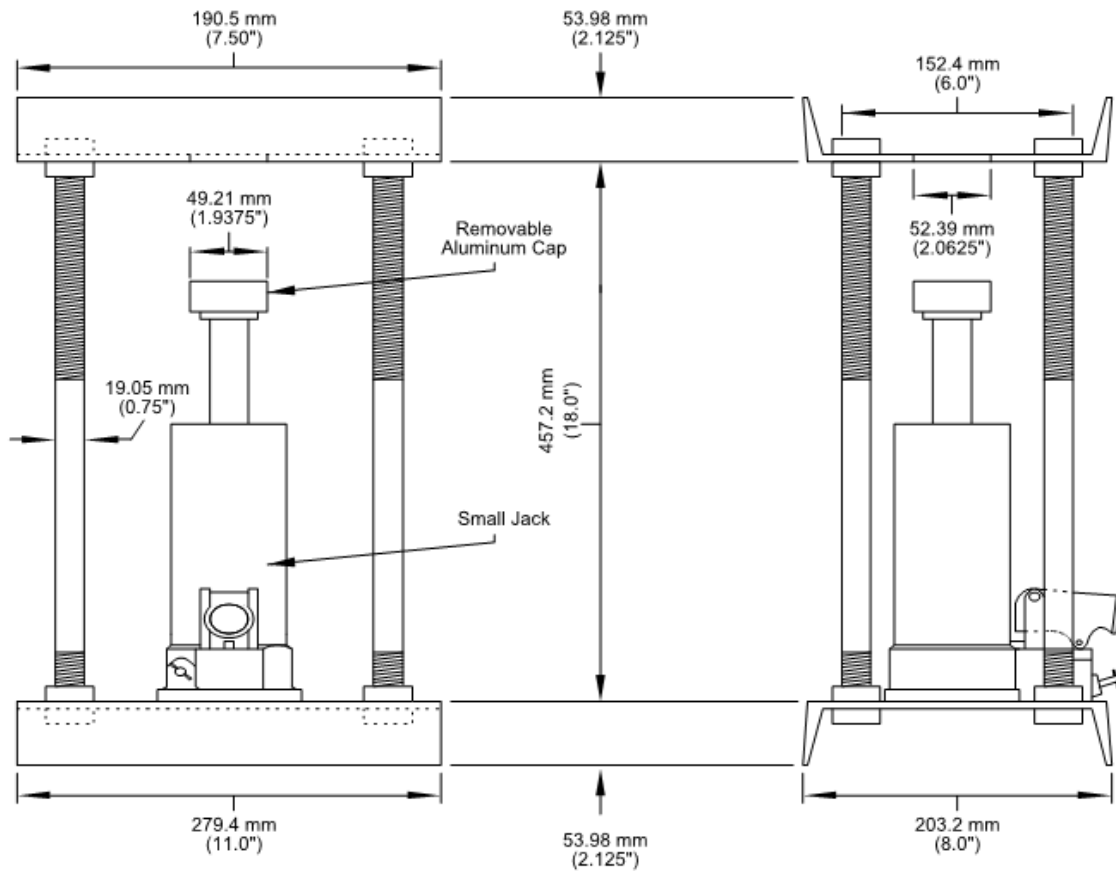

Figure B.4.2-3 Sample Extruder

B.4.3 Samples

Samples of soil and the appropriate lime content shall be provided as follows: 200 pounds of soil and 25 pounds of lime.

B.4.4 Procedure

- (a) Soil Preparation - The soil, as received, shall be prepared for test according to AASHTO R 58 and Illinois Modified AASHTO T 99.
- (b) Mechanical Analysis - The particle size analysis of the soil shall be determined according to AASHTO T 88.
- (c) PI of Soil - The PI of the soil shall be determined according to AASHTO T 90.

Geotechnical Manual

Appendix B Laboratory Testing and Mix Design Procedures

- (d) Moisture-Density Relationship - The moisture-density relationship of the soil-lime mixture shall be determined according to Illinois Modified AASHTO T 99 (see Note 1). The soil and lime shall be dry mixed until a homogeneous mixture is obtained. The water shall be added, and the mixture thoroughly re-mixed. The moist mixture shall then be placed in a suitable container, formed into a lightly compacted mound, and then sealed to prevent moisture loss. The mixture shall be allowed to mellow for a period of one-hour before compaction.

Note 1. At each moisture content and each lime content, a separate, new sample of material shall be used, as described in Note 8 of Illinois Modified AASHTO T 99.

Since, for most soils, there is close agreement of moisture-density relationships for lime-soil mixtures with 3 to 8% lime, it is generally acceptable to determine the moisture-density relationship at 5% lime. Therefore, the moisture-density relations may not have to be established for the soil-lime mixtures at other lime contents. Instead, the resultant OMC is then adjusted up or down $\frac{1}{2}\%$ water per 1% lime increase or decrease, respectively, for the other mixtures.

- (e) Preparation of Test Specimens - Four test specimens at each lime content to be considered, and four non-treated soil test specimens shall be molded at OMC and SDD, using the mixing procedure defined above. Each specimen shall be compacted dynamically, in the 2 inch X 4 inch (51 mm X 102 mm) mold, in three equal layers. The number of blows per layer, with the sliding hammer, shall be adjusted to obtain the SDD. It is important, that each of the first two lifts be scarified to promote bonding. The compacted sample is then trimmed, extracted, weighed, and mass recorded.
- (f) Curing of Specimens - Cure the non-treated soil and lime-soil specimens at their molded moisture content, in sealed containers, in a temperature controlled oven. The specimens shall be cured at $120^{\circ} \pm 4^{\circ}$ F ($49^{\circ} \pm 2^{\circ}$ C), for a period of 48 hours. The specimens shall then be removed from the curing containers and cooled to room temperature.
- (g) Compression Testing - Test each specimen to failure, at a constant rate of 0.05 inches (1.27 mm) per minute. The compressive strength shall be determined according to AASHTO T 208. Obtain a moisture sample from each failed specimen. The moisture sample is for evaluating the adequacy of the container seal during the curing period and calculating the

Geotechnical Manual

Appendix B Laboratory Testing and Mix Design Procedures

dry density of the specimens. The moisture content shall be determined according to Illinois Modified AASHTO T 265.

- (h) Evaluation of Compression Test Results - Compare the average maximum compressive strength of the non-treated specimens, to those of the soil-lime specimens.
- (i) Design Recommendations - The minimum recommended lime content is the value which provides a compressive strength gain of 50 psi (345 kPa) over that of the untreated soil, and provides a minimum average compressive strength of 100 psi (680 kPa) for the treated soil. The minimum lime content is increased by 1% to offset construction loss or uneven distribution. This new value is called the design lime content.

B.4.5 Report

- (a) Route
- (b) Section
- (c) County
- (d) Job No.
- (e) Material Identification and Source
- (f) AASHTO M 145 Classification and the Group Index
- (g) IDH Textural Classification
- (h) Laboratory OMC and SDD (Illinois Modified AASHTO T 99, Method A) of the Soil-Lime Mixture
- (i) Gradation (AASHTO T 88)
- (j) The PI (AASHTO T 90)
- (k) Percent Lime for Test Specimens
- (l) Compressive Strength psi (kPa) for Test Specimens (AASHTO T 208)
- (m) Plot of Percent Lime Versus Compressive Strength
- (n) Recommended Lime Percentage
- (o) The IBR and the Amount of Swell (Optional)

Geotechnical Manual

Appendix B Laboratory Testing and Mix Design Procedures

B.5 Soil-Cement Mixture: Laboratory Evaluation/Design Procedure

B.5.1 Scope

This method is to determine the proportions of soil, water, and either Type 1 or Type 1A Portland Cement which, when incorporated in a mixture with water, will provide durable support as a base course.

B.5.2 Equipment

Equipment necessary to perform Illinois Modified AASHTO T 134, and AASHTO R 58, T 27, T 88, T 89, T 90, T 135, T 136 and specification M 145.

B.5.3 Samples

Samples of cement and soil shall be provided as required in Section 352 of the [Standard Specifications](#).

B.5.4 Procedure

- (a) The soil shall meet the requirements of the “Soil-Cement Base Course” section of the [Standard Specifications](#).
- (b) The soil gradation shall be determined according to AASHTO T 27 and T 88.
- (c) The LL and the PL shall be determined according to AASHTO T 89 and T 90, respectively. Calculate the Plasticity Index (PI) by subtracting the PL from the LL.
- (d) Using the gradation data obtained from T 88, along with the PI and LL, use AASHTO M 145 to determine the AASHTO Soil Group Classification.
- (e) Use the Group Classification and [Table B.5.4-1](#) (fourth column) to determine the estimated cement content to be used in the moisture-density test performed according to Illinois Modified AASHTO T 134. “A” horizon soils may contain organic, or other material that may

Geotechnical Manual
Appendix B Laboratory Testing and Mix Design Procedures

deter cement reaction, and may require much higher cement percentages. For most “A” horizon soils, the cement contents (given in [Table B.5.4-1](#)) should be increased by 4 percentage points if the soil is dark grey to grey and 6 percentage points if the soil is black. It is not necessary to increase the cement percentage for brown or red “A” horizon soils.

AASHTO Soil Group Classification	Usual range in cement requirement		Estimated cement content and that used in moisture-density test	Cement contents for wet-dry and freeze-thaw tests
	% by Volume	% by Mass	% by Mass	% by Mass
A-1-a	5 - 7	3 - 5	5	3 - 4 - 5 - 7
A-1-b	7 - 9	5 - 8	6	4 - 6 - 8
A-2	7 - 10	5 - 9	7	5 - 7 - 9
A-3	8 - 12	7 - 11	9	7 - 9 - 11
A-4	8 - 12	7 - 12	10	8 - 10 - 12
A-5	8 - 12	8 - 13	10	8 - 10 - 12
A-6	10 - 14	9 - 15	12	10 - 12 - 14
A-7	10 - 14	10 - 16	13	11 - 13 - 15

(Reprinted courtesy of the Portland Cement Association)

Table B.5.4-1 Cement Requirements of AASHTO Soil Group Classification

- (f) Compact 2 specimens at the estimated cement content used in B.5.4(e) according to Illinois Modified AASHTO T 134. Also, compact 4 additional samples: two samples at 2 percentage points lower than the estimated cement content and two samples at 2 percentage points higher than the estimated cement content. Compact the specimens to the maximum dry density determined in Appendix B.5.4(e) above.
- (g) Moist cure the compacted specimens for 7 days. Cap the samples and soak them in room temperature water for 4 hours. Perform the compressive strength according to Illinois Modified AASHTO T 22. The 7-day compressive strength (with no correction for the length-to-diameter ratio) shall meet or exceed 500 psi (3500 kPa) or a specified design strength, whichever is greater. Samples with a cement content not meeting the strength requirement are not to be tested further.

Geotechnical Manual

Appendix B Laboratory Testing and Mix Design Procedures

In the event that the initial estimated cement content (the cement content at which the moisture-density relationship was developed) fails to meet the strength requirement, choose a higher cement content and re-run the moisture-density test (Illinois Modified AASHTO T 134). Compact specimens as in B.5.4(f). Perform compressive strength test as described above in (g).

- (h) Choose the lowest cement content that meets the compressive strength requirement. Following procedures described in T 135 (Wet / Dry Testing), mold specimens at the lowest cement content. Mold additional samples at 2 and 4 percent higher cement content. Test all specimens according to T 135.
- (i) Mold specimens as described in T 136 (Freeze / Thaw Test) at the lowest cement content that meets strength requirement. Mold additional samples at 2 and 4 percent higher cement content. Test all specimens according to T 136.
- (j) Determine the maximum allowable soil-cement loss percentage according to AASHTO T 135 and T 136. The maximum allowable losses, as determined by either of the tests, shall be as follows:

<u>Soil Group Classification</u>	<u>Maximum Allowable Loss (%)</u>
A-1, A-2-4, A-2-5, A-3	14
A-2-6, A-2-7, A-4, A-5	10
A-6, A-7	7

- (k) The design cement content shall be the minimum required to meet the allowable soil-cement loss percentage and the compressive strength requirement specified in Appendix B.5.4(g) above.

Geotechnical Manual

Appendix B Laboratory Testing and Mix Design Procedures

B.5.5 Report

- (a) Route
- (b) Section
- (c) County
- (d) Job Number
- (e) Material Identification and Source
- (f) Maximum Dry Density and Optimum Moisture Content (Illinois Modified AASHTO T 134)
- (g) % Cement by Mass
- (h) % Cement by Volume
- (i) Lb. (Kg) of cement per ft² (m²) per 1 inch (25 mm) of compacted thickness
- (j) AASHTO Group Classification (AASHTO M 145)
- (k) Soil-Cement Loss % Wet-Dry (AASHTO T 135)
- (l) Soil-Cement Loss % Freeze-Thaw (AASHTO T 136)
- (m) Compressive Strength (Illinois Modified AASHTO T 22), kPa (psi)
- (n) The LL and PL (AASHTO T 89 and T 90, respectively)
- (o) Fine and Coarse Aggregate Sieve Analysis (AASHTO T 27)
- (p) Hydrometer Analysis (AASHTO T 88)

Geotechnical Manual

Appendix B Laboratory Testing and Mix Design Procedures

B.6 Cement Aggregate Mixture: Laboratory Evaluation/Design Procedures

B.6.1 Scope

This method is to determine the proportions of cement and aggregate which, when incorporated in a mixture with water, will provide a workable, durable subbase.

B.6.2 Apparatus

Equipment necessary to perform Illinois Modified AASHTO T 99 (Method C) and T 134; and AASHTO R 58, T 11 / T 27, T 88, T 89, T 90, T 135 and T 136.

B.6.3 Samples

Samples of cement and aggregate shall be provided as required in Article 312.10 of the 2012 Edition of the [Standard Specifications](#).

B.6.4 Procedure

- (a) Prepare the aggregate according to AASHTO R 58 and determine the moisture content according to Illinois Modified AASHTO T 265.
- (b) Determine the particle size gradation of the aggregate according to AASHTO T 11/T 27 and T 88.
- (c) Determine the moisture-density relationships of the cement-aggregate mixture at 5, 6.5 and 8% cement by dry mass of the aggregate, according to Illinois Modified AASHTO T 134.
- (d) Freeze-Thaw and Wet-Dry losses shall be determined at 5, 6.5 and 8% cement, according to AASHTO T 135 and T 136. The loss in mass shall not be more than 10% after 12 freeze-thaw or wet-dry cycles.
- (e) The design cement content shall be the minimum required to meet the allowable loss specified in B.6.4(d) above.

Geotechnical Manual

Appendix B Laboratory Testing and Mix Design Procedures

B.6.5 Reports

- (a) Route
- (b) Section
- (c) County
- (d) Job Number
- (e) Material Identification and Source
- (f) Maximum Dry Density and Optimum Moisture Content (Illinois Modified AASHTO T 134)
- (g) % Cement by Dry Mass of the Aggregate
- (h) Particle Size Gradation (AASHTO T 27 / T 11 and T 88)
- (i) Aggregate Classifications (AASHTO M 145)
- (j) % Loss Wet-Dry
- (k) % Loss Freeze-Thaw

Geotechnical Manual

Appendix B Laboratory Testing and Mix Design Procedures

B.7 Pozzolanic Stabilized Mixture: Laboratory Evaluation/Design Procedure

B.7.1 Scope

This method is to determine those proportions of an activator, pozzolan (fly ash), and aggregate which, when incorporated in a mixture with water, will provide a durable subbase or base course. Activator refers to either lime or cement.

B.7.2 Equipment

Equipment necessary to perform Illinois Modified AASHTO T 180 (Method C), and AASHTO R 58, T 27 / T 11, T 88, T 89, T 90, T 255, and ASTM C 311.

B.7.3 Samples

Samples of aggregate, activator and pozzolan shall be provided as required in Article 312.16 of the 2012 Edition of the [Standard Specifications](#).

B.7.4 General Approach

For a given set of component materials, the significant factors which may be varied are the ratio of an activator to pozzolan, and the ratio of the activator plus pozzolan to the aggregate. The activator to pozzolan ratio affects, primarily, the quality of the "matrix"; and the ratio of the activator plus pozzolan to aggregate, primarily, determines the quantity of matrix available to fill the voids of the aggregate, thus, assuring that the matrix-aggregate particle contact is maximized.

The concept of providing sufficient matrix to fill the voids in the aggregate is applicable, primarily, to aggregates containing sufficient amounts of coarse, + 4.75 mm (+ No. 4), aggregate, to create large void spaces. However, in the event that the aggregate contains a high fraction of fine material, - 4.75 mm (- No. 4), the concern should shift to not only providing sufficient matrix, but to the ability of the resultant mixture to compact and remain stable during construction. Thus, it may be necessary to reduce the amount of matrix in the mixture, or otherwise, reduce the overall fineness of the aggregate through blending.

Geotechnical Manual

Appendix B Laboratory Testing and Mix Design Procedures

B.7.5 Preliminary Testing (Optional)

Preliminary evaluations of activators and pozzolans may be performed to select the activator-pozzolan ratio which provides the greatest strength development. This may be accomplished according to Section 9 of ASTM C 593.

B.7.6 Preparation of Aggregate/Pozzolan

- (a) Determine the particle size gradation for the aggregate and fly ash, according to AASHTO T 27 / T 11. The aggregate and fly ash gradations shall meet the requirements of the 2012 Edition of the [Standard Specifications](#).
- (b) Sieve and discard, if any, the aggregate retained on the 3/4 inch (19 mm) sieve.
- (c) Determine the evaporable moisture content according to AASHTO T 255, and absorption according to AASHTO T 84, of the aggregate fraction passing the No. 4 (4.75 mm). Determine the moisture content of the pozzolan according to ASTM C 311.

If the aggregate fraction between the 3/4 inch (19 mm) and the No. 4 (4.75 mm) sieve does not contain free surface moisture, that fraction shall be soaked 24 hours, and towel dried to obtain a saturated surface dry condition according to AASHTO T 85. Pozzolan which has agglomerated, due to drying, shall be crumbled with the fingers until the overall size is reduced to comply with the 2012 Edition of the [Standard Specifications](#).

B.7.7 Moisture-Density Relationship

Aggregates, pozzolan, and activator shall be proportioned on a dry mass basis. The moisture-density relationship, SDD and OMC of each trial mixture shall be determined, according to Illinois Modified AASHTO T 180, Method C, except that three lifts shall be used instead of the five lift requirement. In determining the moisture-density relationship, dry materials shall be mixed in a counter current mechanical mixer (or its equivalent) for 1 minute, or until the mixture is uniform in color and texture; plus, an additional 3 minutes (after the water is added) in order to obtain the first point on the moisture-density curve. New material should be used for subsequent trials.

Geotechnical Manual

Appendix B Laboratory Testing and Mix Design Procedures

B.7.8 Mix Design Procedure

- (a) Using [Table B.7.8-1](#), determine the approximate initial proportions of activator and pozzolan for two trial mixtures. For example, using lime as the activator, and natural aggregate; trial 1 should contain 3.5% lime, and 10.5% pozzolan. The estimated amount of material needed to pass the No. 4 (4.75 mm) sieve, for a given maximum nominal aggregate particle size, is shown in [Table B.7.8-2](#). The maximum nominal aggregate particle size is the largest sieve size which retains material. Blending aggregates may be necessary to obtain a sufficiently fine mixture, while keeping activator and pozzolan amounts at economical levels.
- (b) Determine the SDD and OMC of each trial mix, as previously outlined.

Trial #	Activator		Natural Aggregate	Boiler Slag Aggregate
	Cement	Lime	Pozzolan	Pozzolan
1	3	0	9	24
	0	3.5	10.5	26
2	4	0	12	28
	0	4.5	13.5	30

Table B.7.8-1 Suggested Percentages (Dry Weight Basis) of Ingredients to be Used in Pozzolanic Stabilized Mixture Design

(The above values may be adjusted to suit a particular situation.)

Maximum Nominal Aggregate Particle Size	Minimum % of Total Batch Passing No. 4 (4.75 mm) Sieve
	Activator + Pozzolan + Minus No. 4 (4.75 mm) Sieve Aggregate
25.4 mm (1 inch)	45%
19.0 mm (3/4 inch)	50%
12.7 mm (1/2 inch)	60%

Table B.7.8-2 Estimation of – No. 4 (4.75 mm) Material Needed

Geotechnical Manual

Appendix B Laboratory Testing and Mix Design Procedures

- (c) Compare the SDD of the two mixes. If the SDD increases between the first and second trial mix, either increase the percentage of activator and pozzolan, holding the ratio constant; or increase the percentage of one ingredient, while maintaining a constant percentage of the other. If the SDD decreases significantly, either decrease the percentage of activator and pozzolan, holding the ratio constant; or decrease the percentage of one ingredient, while maintaining a constant percentage of the other.
- (d) Repeat these procedures until the SDD remains constant; or decreases slightly, between two consecutive mixtures. The percentage of pozzolan and activator that produces the maximum SDD, between those two mixtures, should be used in further testing.

B.7.9 Determining Compressive Strength

- (a) Mixing and Molding Test Specimens

After the SDD and OMC are obtained as outlined above in B.7.7, a batch large enough to make six (6) cylinders, each 4.0 inch x 4.6 inch (102 mm by 117 mm), shall be mixed in the following manner: Mix the dry materials for 1 minute, or until the mixture is uniform in color and texture, in a counter current mechanical mixer or its equivalent. Add enough water to bring the mixture to OMC {corrected for the hygroscopic moisture of the minus No. 4 (4.75 mm) material}. Mix an additional 3 minutes. Mold the specimens immediately, according to Illinois Modified AASHTO T 180, Method C, except that three lifts shall be used instead of the five lift requirement. Each lift shall be scarified to a depth of 1/4 inch (6 mm) before the next layer is compacted, in order to assure a good bond between the layers. Weigh a representative sample of the mixture, to determine the moisture content (use a container with a tight lid to prevent loss of moisture). Then carefully remove the specimen from the mold, by the use of a sample extruder such as a jack, a lever frame or other suitable device (see [Appendix B.4.2](#)).

- (b) Curing of Test Specimens

Immediately after the specimens are removed from the mold, re-weigh the specimens and place them in a sealed container, to prevent any loss of moisture. The sealed container may be either a can with a friction lid, or double sealed plastic bags. Place three of the

Geotechnical Manual

Appendix B Laboratory Testing and Mix Design Procedures

specimens, in the sealed containers, in a room or cabinet with forced air circulation maintained at 50° F ± 2° F (10° C ± 1° C), for a 7-day period. Place the remaining three (3) specimens, in the sealed containers, in a room or cabinet with forced-air circulation maintained at 72° F ± 2° F (22° C ± 1° C), for a fourteen day period; re-weigh and allow to cool to room temperature. After the required period, remove the specimens from the containers, and cap the specimens for compressive strength testing. Soak the specimens in water for 4 hours, remove, allow to drain on a nonabsorbent surface, and test within 1 hour of the time of removal from the water.

(c) Vacuum Saturation (Optional)

If, specified or required, the Vacuum Saturated Compressive strength shall be determined according to Section 11 of ASTM C 593.

(d) Compression Testing

Specimens shall be tested according to Illinois Modified AASHTO T 22, with no length-to-diameter ratio correction for computation of the compressive strength. The average compressive strength of three specimens, tested at each curing condition, shall be designated as the test value for evaluation. The average vacuum saturation strength (if required) of the three specimens tested, shall be designated as the test value for evaluation. Coefficients of variation within groups, at each curing condition which exceed 10% for 50° F (10° C) and 10% for 72° F (22° C), shall be considered as cause for rejection of the samples; and a fresh batch shall be formulated, compacted, and tested. If the number of values is not large (say, less than 10), the corrected standard deviation shall be estimated by either of the following equations:

$$s_e = \frac{R}{d} \text{ or} \quad (\text{Eq. B.7.9-1})$$

$$= R \times m \quad (\text{Eq. B.7.9-2})$$

Geotechnical Manual

Appendix B Laboratory Testing and Mix Design Procedures

Where: s_e = estimated standard deviation
 R = range of values; i.e. the difference between the greatest value and the smallest value
 d = factor (see [Table B.7.9-1](#))
 m = factor (see [Table B.7.9-1](#))

Number of Values n	Factor d	Factor m
2	1.1284	0.8862
3	1.6926	0.5908
4	2.0588	0.4857
5	2.3259	0.4299
6	2.5344	0.3946
7	2.7044	0.3698
8	2.8472	0.3512
9	2.9700	0.3369
10	3.0775	0.3249

Table B.7.9-1 Factors for Estimating Standard Deviation

The coefficient of variation is computed by dividing the corrected standard deviation by the average strength. For subbase or base courses, the cylinders cured at 72° F ± 2° F (22° C ± 1° C), for 14 days, should have a minimum average compressive strength of 600 psi (4.1 MPa), with no individual test below 500 psi (3.4 MPa).

B.7.10 Plotting of Cured Compressive Strength (CS) vs. Degree Days (DD) Characteristic Curve

To evaluate the effect of curing at low to moderate field temperatures, the average cured compressive strength (CS), obtained at both curing temperatures, shall be plotted versus the curing degree days (DD). The degree days are calculated as follows:

$$DD = [\text{Curing temperature (°C)} - 4.4^\circ \text{C}] \times \text{number of days} \quad (\text{Eq. B.7.10-1})$$

Geotechnical Manual

Appendix B Laboratory Testing and Mix Design Procedures

Where the 40° F (4.4° C) is base temperature representative of each average strength.

Plots are to be arranged on 20 x 20/division graph-paper (at a convenient scale) with the DD plotted along the x-axis, and the CS along the y-axis. The “best fit” straight line relationship shall be plotted to obtain the CS value at the degree days corresponding to 14-day curing. Plots shall be appropriately labeled as to: producer, month and year of analysis, and proportions of each component ingredient.

The DGE will analyze design test data, develop appropriate construction cut-off dates and predict the DD value, based on the anticipated temperatures during construction.

B.7.11 Report

Report of the mix design, compressive strength, and/or vacuum saturation strength tests shall include the following:

- (a) Identification of each material used in the preparation of the specimens
- (b) Aggregate gradation
- (c) Percentage, by dry mass, of each of the constituents
- (d) Actual, as compacted, percentage moisture content of mixture (Illinois Modified AASHTO T 180)
- (e) Actual dry density of each specimen, to the nearest lb/ft³ or kg/m³ (Illinois Modified AASHTO T 180)
- (f) Percentage compaction of each specimen
- (g) Cross-sectional area of each specimen, in.² or mm².
- (h) Compressive strength of each specimen, to the nearest 5 psi or 50 kPa and/or (Illinois Modified AASHTO T 22, with no correction for length-to-diameter ratio)
- (i) Vacuum saturation strength (if required) of each specimen, to the nearest 5 psi or 50 kPa (ASTM C 593)
- (j) Plot of cured compressive strength versus degree day curve

Appendix C Field Test Procedures and References

C.1 Field Test Procedure for Unconfined Compressive Strength of Cohesive Soil (Rimac)

C.1.1 Scope

This test method covers the determination of the unconfined compressive strength (Q_u) of cohesive soil using a strain-controlled application of axial load with a small, portable compression device.

Note 1 – This test method is commonly referred to as the Rimac test after the equipment used in its development.

This test method provides an approximate value of the strength of cohesive soils in terms of total stresses.

In practice, a portable hand-operated or mechanically-driven compression device is taken to the job site, and cohesive samples recovered from a soil boring are tested for the unconfined compressive strength. Samples recovered and field tested are typically from the standard split spoon used in AASHTO T 206 (Standard Penetration Test) or by other field sampling methods using continuously pushed or driven split barrel samplers of various diameters.

Note 2 – Note that test samples obtained from split spoon samplers are usually considered quite disturbed due to the ratio of the thickness of the sampler wall to the sample diameter.

Note 3 – This test method can also be used on cohesive soil in the intact (relatively undisturbed), remolded, or compacted condition obtained by other sampling and preparation methods which are beyond the scope of this test method.

Frozen soils cannot be tested with this method to obtain valid unconfined compressive strength values.

Geotechnical Manual

Appendix C Field Test Procedures and References

This test method is applicable only to cohesive materials that will not expel bleed water (water expelled from the soil due to deformation or compaction) during the loading portion of the test and that will retain intrinsic strength after removal of confining pressures, such as clays or cemented soils. Dry and crumbly soils, fissured or varved materials, non-cohesive silts, peats, and sands may not be conducive to testing with this method to obtain valid unconfined compressive strength values. In such cases, a note should be made on the field log if it appears that the test results may not be accurate.

Note 4 – Samples of soils having slickensided or fissured structure, samples of some types of loess, very soft clays, dry and crumbly soils and varved materials, or samples containing significant portions of silt or sand, or both (all of which usually exhibit cohesive properties), frequently display higher shear strengths when tested in accordance with AASHTO T 296. Also, unsaturated soils will usually exhibit different shear strengths when tested in accordance with AASHTO T 296.

This test method is an adaptation of AASHTO T 208 for the performance of tests in the field. The determination of the unconsolidated, undrained strength of cohesive soils with lateral confinement is covered by AASHTO T 296. This test method is not a substitute for AASHTO T 296.

C.1.2 Referenced Documents

American Association of State Highway and Transportation Officials (AASHTO) Standards:

- M 145, Classification of Soils and Soil-Aggregate Mixtures for Highway Construction Purposes
- T 88, Particle Sized Analysis of Soils
- T 206, Standard Method of Test for Penetration Test and Split-Barrel Sampling of Soils
- T 207, Thin-Walled Tube Sampling of Soils
- T 208, Unconfined Compressive Strength of Cohesive Soil
- T 265 (Illinois Modified), Laboratory Determination of Moisture Content of Soils
- T 296, Unconsolidated, Undrained Compressive Strength of Cohesive Soils in Triaxial Compression

Geotechnical Manual

Appendix C Field Test Procedures and References

American Society for Testing and Materials (ASTM) Standards:

- D 653, Standard Terminology Relating to Soil, Rock, and Contained Fluids
- D 3550, Standard Practices for Thick Wall, Ring-Lined, Split Barrel, Drive Sampling of Soils
- D 4220, Standard Practices for Preserving and Transporting Soil Samples
- E 29 (Illinois Modified), Using Significant Digits in Test Data to Determine Conformance with Specifications

Illinois Department of Transportation (IDOT), *Geotechnical Manual*, 1999

Illinois Division of Highways, "*Field Boring Manual for Personnel Assigned to District Foundation Boring Units*", 1960

Bowles, Joseph E., (Fourth Edition), "*Engineering Properties of Soils and Their Measurement*", McGraw-Hill, Inc., 1992

C.1.3 Terminology

Refer to ASTM D 653 for standard definitions of terms except as listed below.

Gravel – rounded or semi-rounded particles of rock that will pass the 3-in. (75-mm) sieve and be retained on a No. 10 (2.00-mm) sieve.

Sand – particles of rock passing the No. 10 (2.00-mm) sieve and retained on a No. 200 (0.075-mm) sieve.

Description of terms specific to this test method:

Unconfined Compressive Strength (Q_u) – The compressive stress at which an unconfined cylindrical specimen of soil will fail in a simple compression test. In this test method, unconfined compressive strength is taken as the maximum load attained per unit area or the load per unit area at 15 percent axial strain (or other specified failure strain), whichever is secured first during the performance of a test.

Geotechnical Manual

Appendix C Field Test Procedures and References

Undrained Shear Strength (s_u) – For unconfined compressive strength test specimens, the undrained shear strength is calculated to be one-half of the compressive strength (Q_u) at failure.

C.1.4 Significance and Use

The primary purpose of this test is to quickly obtain the approximate unconfined compressive strength of soils which possess sufficient cohesion to permit testing in the unconfined state in the field. The unconfined compressive strength, Q_u , obtained in this manner is not likely to differ significantly from the more precise laboratory method AASHTO T 208.

Refer to [Appendix C.1.1](#) for limitations on use.

C.1.5 Equipment

Compression Device (Rimac Spring Tester, which is a modified automotive valve spring tester, or equivalent device) – A portable compression testing device with sufficient capacity and control to provide the rate of loading prescribed in [Appendix C.1.7](#) (Note 5). This compression device may be either hand-operated or mechanically-driven. For soil with an unconfined compressive strength of less than 1.0 ton/ft² (100 kPa), the compression device shall be capable of measuring the compressive stress to within 0.01 ton/ft² (1 kPa). For soil with an unconfined compressive strength of 1.0 ton/ft² (100 kPa) or greater, the compression device shall be capable of measuring the compressive stress to the nearest 0.05 ton/ft² (5 kPa).

Note 5 – The valve spring tester device was originally only available for purchase with a pull handle as shown in [Figure 4.4.5.2.1-1\(a\)](#). To provide a mechanism to control the strain rate, the device was retooled by replacing the pull handle with an gearing system developed by the Department as shown in [Figure 4.4.5.2.1-1\(b\)](#). The gear box modification is designed for 1/32 in. of vertical deformation per revolution of the hand crank. Shop drawings for the aftermarket gear modification can be obtained by contacting the Central Bureau of Materials. However, some soil testing equipment providers now offer a device for purchase with the gearing modification.

Geotechnical Manual

Appendix C Field Test Procedures and References

Deformation Indicator – The deformation indicator shall be a scale mounted on the device graduated to 1/16 in. (0.01 cm) or better and having a travel range of at least 20 percent of the length of the test specimen, or some other measuring device, meeting these requirements.

Dial Comparator, or other suitable device, for measuring the physical dimensions of the specimen to within 0.1 percent of the measured dimension.

Note 6 – Most drill crews assume a standard specimen diameter based on the inside diameter of the split spoon sampler and use a template to trim a standard height.

Note 7 – Vernier calipers are not recommended for soft specimens, which will deform as the calipers are set on the specimen.

Timer – A timing device indicating the elapsed testing time to the nearest second shall be used for establishing the rate of strain application prescribed in [Appendix C.1.7](#).

Miscellaneous Apparatus, including specimen trimming and carving tools, data sheets, as required and for further laboratory testing, water content cans, glass or plastic jars or plastic sealable bags or pails.

C.1.6 Test Specimen Preparation

Specimen Size – Specimens shall have a minimum diameter of 1.3 in. (30 mm), and the largest particle contained within the test specimen shall be smaller than one-tenth of the specimen diameter. Specimens from SPT split spoons typically have a constant inside diameter of 1½ in. (35 mm). The specimens may vary in diameter depending on the diameter of the sampler used. For specimens having a diameter of 2.8 in. (72 mm) or larger, the largest particle size shall be smaller than one-sixth of the specimen diameter. If, after completion of a test on a specimen, it is found, based on visual observation, that larger particles than permitted are present, indicate this information in the remarks section of the report of test data (Note 8). The height-to-diameter ratio shall be greater than or equal to 1.7 and less than or equal to 2.0. Average sample dimensions may be assumed based on the sampler inside diameter and standard height from a trimming template (Note 9). Otherwise, determine the average height and diameter of the test specimen using the apparatus specified in [Appendix C.1.5](#) by taking a minimum of three height

Geotechnical Manual

Appendix C Field Test Procedures and References

measurements (120 degrees apart) and at least three diameter measurements at the quarter points of the height (1/4 height, 1/2 height, 3/4 height) for a total of nine diameter measurements.

Note 8 – If large soil particles are found in the sample after testing, a particle-sized analysis performed in accordance with AASHTO T 88 may be performed to confirm the visual observation and the results provided with the test report.

Note 9 – The standard test sample dimensions from a split spoon sampler is 1 $\frac{3}{8}$ in. (35 mm) diameter and trimmed to 2 $\frac{1}{2}$ in. length using a trimming template. This length is for ease in field calculating the percent strain at failure.

Field Specimens – Prepare field specimens from samples secured from a split barrel sampler in accordance with AASHTO T 206, a driven or continuous push split barrel sampler in accordance with ASTM D 3550, or other specified method using a split barrel sampler. Split spoon (split barrel) soil specimens may be tested without trimming except for the squaring of ends to the specified height outlined in [Appendix C.1.6](#), if conditions of the sample justify this procedure. Handle the specimens carefully to prevent disturbance, changes in cross section, or loss of water content. Open the split spoon sampler lengthwise carefully to facilitate removal of the specimen without disturbance. Prepare trimmed specimens without disturbance. Make every effort to prevent any change in water content of the soil. Specimens shall not be allowed to freeze at any time before, during or after the test procedure. Specimens shall be of uniform circular cross section with ends perpendicular to the longitudinal axis of the specimen. When carving or trimming, remove any small pebbles or shells encountered. Carefully fill voids on the surface of the specimen with remolded soil obtained from the trimmings. When sample condition permits, a vertical lathe that will accommodate the total sample may be used as an aid in carving the specimen to the required diameter. Determine dimensions of the test specimen. If the entire test specimen is not to be used for determination of water content, secure a representative sample of cuttings for this purpose, placing them immediately in a covered or sealed container to be preserved and transported to a laboratory in accordance with the practices for Group B samples in ASTM D 4220.

Geotechnical Manual

Appendix C Field Test Procedures and References

Moisture Specimens – Specimens may be preserved and transported in accordance with the practices for Group B samples in ASTM D 4220 for moisture content determination and other index property testing in a laboratory. Preserve and transport samples in sealed, moisture proof containers. All containers shall be of sufficient thickness and strength to ensure against breakage and moisture loss. The container types include: plastic bags or pails and glass or plastic (provided they are waterproof) jars. If using plastic bags, place the plastic bags as tightly as possible around the sample, squeezing out as much air as possible. They shall be 3 mil or thicker to prevent leakage. If using glass or plastic jars, seal the lids with wax if the jar lids are not rubber ringed or lined with new waxed paper seals. If using plastic pails seal them with wax or tape if the plastic pail lids are not airtight. Transport samples by any available transportation. Ship samples as prepared or placed in larger shipping containers, including bags, cardboard, or wooden boxes or barrels. Samples shall be stored and transported in a manner such that they are not subject to being frozen at any time.

C.1.7 Procedure

Place the sample in the loading device, Rimac, so it is centered on the bottom platen in an upright position. Adjust the loading device carefully so the upper platen just makes contact with the specimen. Verify that the vertical scale is mounted correctly, or zero the deformation indicator. Zero the maximum load dial indicator. Apply the load in a slow and uniform manner so as to produce an axial strain at a rate of 0.5 to 6 percent per minute. The rate of load application, by turning the hand crank, is one complete handle revolution every 12 seconds, which is 5 revolutions per minute (Note 10). The average time, per test, ranges from 3 to 6 minutes. The rate of strain should be chosen so the time to failure does not exceed about 15 minutes (Note 11). Continue loading until the load values decrease with increasing strain or until 15 percent strain, or other specified maximum strain, is reached. Record peak load and deformation at failure.

Note 10 – This strain rate may also be achieved by attaching the proper gear ratio to a motor.

Note 11 – Softer materials that will exhibit larger deformation at failure should be tested at a higher rate of strain. Conversely, stiff or brittle materials that will exhibit small deformations at failure should be tested at a lower rate of strain.

Record the type of failure (that is, bulge, diagonal shear, etc.).

Geotechnical Manual

Appendix C Field Test Procedures and References

Unless representative cuttings are obtained for this purpose, the test specimen is to be used for determination of water content in accordance with Illinois Modified AASHTO T 265. Place it immediately in a covered or sealed container to be preserved and transported to a laboratory in accordance with the practices for Group B samples in ASTM D 4220 after the compression test is completed.

C.1.8 Calculations

Calculate the axial strain, ϵ_1 , to the nearest 0.1 percent, for a given applied load, as follows:

$$\epsilon_1 = \Delta L / L_o \quad (\text{Eq. C.1.8-1})$$

where:

ΔL = length change of specimen as read from deformation indicator, in. (mm)

L_o = initial length of test specimen, in. (mm)

Calculate the average cross-sectional area, A , for a given applied load, as follows:

$$A = A_o / (1 - \epsilon_1) \quad (\text{Eq. C.1.8-2})$$

where:

A_o = initial average cross-sectional area of the specimen, in.² (mm²)

ϵ_1 = axial strain for the given load, percent

Calculate the unconfined compressive strength, Q_u , to three significant figures, or nearest 0.01 ton/ft² (1 kPa), for a given applied load, as follows:

$$Q_u = \frac{0.072P}{A} \quad (\text{ton/ft}^2) \quad (\text{Eq. C.1.8-3a})$$

Geotechnical Manual

Appendix C Field Test Procedures and References

$$Q_u = \frac{1000P}{A} \quad (\text{kPa}) \quad (\text{Eq. C.1.8-3b})$$

where:

P = peak applied load, lbs (N) at failure or maximum specified axial strain, whichever is secured first

A = corresponding average cross-sectional area in² (mm²)

[Table C.1-1](#) can be used to quick determination of the Q_u in the field for standard sized samples. Similar tables for other sample sizes can also be created as applicable.

C.1.9 Report

Test results are typically recorded on the field boring log. The report should include the following:

- (a) Identification and visual description of the specimen, including soil classification, moisture condition, etc. Also include specimen identifying information, such as project, location, boring number, sample number, depth, etc.
- (b) Unconfined compressive strength
- (c) Undrained shear strength (optional)
- (d) Type of failure (that is, bulge – “B”, diagonal shear – “S”, etc.)
- (e) Average height and diameter of specimen if they are “non-standard” dimensions (Note 9)
- (f) Height-to-diameter ratio if it is not the standard 1.8:1 (Note 9)
- (g) Length of time for the test (optional)
- (h) Average rate of strain to failure, percent per minute (optional)
- (i) Strain at failure, percent
- (j) Remarks – Note any unusual conditions or other data that would be considered necessary to properly interpret the results obtained; for example, slickensides, stratification, shells, pebbles, roots, or brittleness.

Geotechnical Manual

Appendix C Field Test Procedures and References

RIMAC UNCONFINED COMPRESSIVE TEST CONVERSION TABLE									
<i>Sample Diameter: 1 3/8 in.</i>					<i>Sample Length: 2 1/2 in.</i>				
Q_u (tsf)									
Dial Reading	Strain				Dial Reading	Strain			
	0%	5%	10%	15%		0%	5%	10%	15%
(lbs)	Loaded Sample Height (in.)				(lbs)	Loaded Sample Height (in.)			
	2 1/2	2 3/8	2 1/4	2 1/8		2 1/2	2 3/8	2 1/4	2 1/8
1	0.05	0.05	0.04	0.04	55	2.67	2.53	2.40	2.27
2	0.10	0.09	0.09	0.08	60	2.91	2.76	2.62	2.47
3	0.15	0.14	0.13	0.12	65	3.15	2.99	2.84	2.68
4	0.19	0.18	0.17	0.16	70	3.39	3.22	3.05	2.89
5	0.24	0.23	0.22	0.21	75	3.64	3.45	3.27	3.09
6	0.29	0.28	0.26	0.25	80	3.88	3.69	3.49	3.30
7	0.34	0.32	0.31	0.29	85	4.12	3.92	3.71	3.50
8	0.39	0.37	0.35	0.33	90	4.36	4.15	3.93	3.71
9	0.44	0.41	0.39	0.37	95	4.61	4.38	4.15	3.92
10	0.48	0.46	0.44	0.41	100	4.85	4.61	4.36	4.12
11	0.53	0.51	0.48	0.45	105	5.09	4.84	4.58	4.33
12	0.58	0.55	0.52	0.49	110	5.33	5.07	4.80	4.53
13	0.63	0.60	0.57	0.54	115	5.58	5.30	5.02	4.74
14	0.68	0.64	0.61	0.58	120	5.82	5.53	5.24	4.95
15	0.73	0.69	0.65	0.62	125	6.06	5.76	5.45	5.15
16	0.78	0.74	0.70	0.66	130	6.30	5.99	5.67	5.36
17	0.82	0.78	0.74	0.70	135	6.55	6.22	5.89	5.56
18	0.87	0.83	0.79	0.74	140	6.79	6.45	6.11	5.77
19	0.92	0.88	0.83	0.78	145	7.03	6.68	6.33	5.98
20	0.97	0.92	0.87	0.82	150	7.27	6.91	6.55	6.18
21	1.02	0.97	0.92	0.87	155	7.52	7.14	6.76	6.39
22	1.07	1.01	0.96	0.91	160	7.76	7.37	6.98	6.59
23	1.12	1.06	1.00	0.95	165	8.00	7.60	7.20	6.80
24	1.16	1.11	1.05	0.99	170	8.24	7.83	7.42	7.01
25	1.21	1.15	1.09	1.03	175	8.49	8.06	7.64	7.21
26	1.26	1.20	1.13	1.07	180	8.73	8.29	7.86	7.42
27	1.31	1.24	1.18	1.11	185	8.97	8.52	8.07	7.62
28	1.36	1.29	1.22	1.15	190	9.21	8.75	8.29	7.83
29	1.41	1.34	1.27	1.20	195	9.46	8.98	8.51	8.04
30	1.45	1.38	1.31	1.24	200	9.70	9.21	8.73	8.24
32	1.55	1.47	1.40	1.32	205	9.94	9.44	8.95	8.45
34	1.65	1.57	1.48	1.40	210	10.2	9.67	9.16	8.66
36	1.75	1.66	1.57	1.48	215	10.4	9.90	9.38	8.86
38	1.84	1.75	1.66	1.57	220	10.7	10.1	9.60	9.07
40	1.94	1.84	1.75	1.65	225	10.9	10.4	9.82	9.27
42	2.04	1.93	1.83	1.73	230	11.2	10.6	10.0	9.48
44	2.13	2.03	1.92	1.81	235	11.4	10.8	10.3	9.69
46	2.23	2.12	2.01	1.90	240	11.6	11.1	10.5	9.89
48	2.33	2.21	2.09	1.98	245	11.9	11.3	10.7	10.1
50	2.42	2.30	2.18	2.06	250	12.1	11.5	10.9	10.3

Table C.1-1 Rimac Conversion Table for 1-3/8 inch Diameter Sample

Geotechnical Manual

Appendix C Field Test Procedures and References

C.2 Comparison of Laboratory and Rimac Q_u Data

Because laboratory tests to determine Q_u are time consuming and expensive, the ability to use field-measured Rimac data to estimate the unconfined compressive strength of soil was studied as part of the [ICT-R27-105 "Bridge Scour Estimation at Sites with Cohesive Soils"](#) research project with the findings summarized in Research Report No. FHWA-ITC-13-025 by [Straub et al. \(2013\)](#). References mentioned herein are listed in the project's report.

To complete this research, IDOT provided a historic dataset containing 366 data pairs of laboratory Q_u and Rimac measurements from various sites across Illinois. Plots of the data and associated statistical analyses results are shown in [Figures C.2.1-1](#) through [C.2.1-4](#).

The following is a reproduction of portions of Section 3.2 of Research Report No. FHWA-ITC-13-025 by [Straub et al. \(2013\)](#):

The proposed Rimac- Q_u relation is shown in [Figure C.2-1](#) and is composed of a combination of two equations using separate prediction intervals. One equation is derived from a linear fit to the smaller Rimac and Q_u values after log-transformation while the other equation is derived from a linear fit to the larger Rimac and Q_u values without transformation. As can be seen from the plots, the prediction interval resulting from the log-transformation for the smaller values accounts for the growth in scatter (heteroscedasticity) as the Rimac and Q_u values increase from zero; whereas for larger values, the prediction interval resulting from the linear fit without transformation accounts for the fact that the scatter has become relatively constant (homoscedastic).

The point prediction (i.e., the solid line near the center of the points in the plots) is given by the following equations:

$$Q_u = 1.0122 \cdot \text{Rimac} - 0.0993 \text{ for Rimac} > 1.06 \quad (\text{Eq. C.2-1})$$

$$Q_u = 0.9222 \cdot \text{Rimac}^{0.8782} \text{ for Rimac} < 1.06 \quad (\text{Eq. C.2-2})$$

The values of these coefficients and their confidence intervals are given in [Table C.2-1](#). Notice that at the 5% significance level, the untransformed slope is not significantly different from 1.0, the untransformed intercept is not significantly different from 0, the log-log slope is not significantly

Geotechnical Manual

Appendix C Field Test Procedures and References

different from 1.0 (though the upper end of the 95% confidence interval is just a little larger than 1.0), and the log-log intercept is not significantly different from 0. These findings mean that neither equation is significantly different from the identity: $Q_u = R_{imac}$.

At $R_{imac} = 1.06$, the two equations give approximately the same value.

From Equation C.2-1,

$$Q_u = 1.0122 * 1.06 - 0.0993 = 0.9737,$$

and from Equation C.2-2,

$$Q_u = 0.9222 * R_{imac}^{0.8782} = 0.9707.$$

The precise intersection of the two regression lines is at the R_{imac} value of 1.045525 and Q_u value of 0.959. Because there are R_{imac} data values between 1.06 and 1.045525, a pair of equations with slightly different coefficients applies at the latter R_{imac} values and equations (1) and (2) are not applicable. However, the approximate agreement at $R_{imac} = 1.06$ was deemed sufficiently accurate.

Transformation	Range of R_{imac} values (tsf)	N	Slope	95% CI of slope	Intercept	95% CI of intercept	Regression SE	Sum of R_{imac} squares (SS_x)	R_{imac} mean
None	$R_{imac} > 1.06$	130	1.0122	(0.8623, 1.1883)	-0.0993	(-0.4546, 0.2560)	1.0911	122.02	1.8447
log-log	$R_{imac} < 1.06$	195	0.8782	(0.7658, 1.0071)	-0.0810	(-0.2468, 0.0848)	0.9323	145.43	0.5705

(N = No. of data points; tsf = tons per square foot; CI = confidence interval; SE= standard error)

Table C.2-1 Results of Regression Analysis for Q_u vs. R_{imac} for 325 Data Pairs from Bridge Sites in Illinois

Geotechnical Manual

Appendix C Field Test Procedures and References

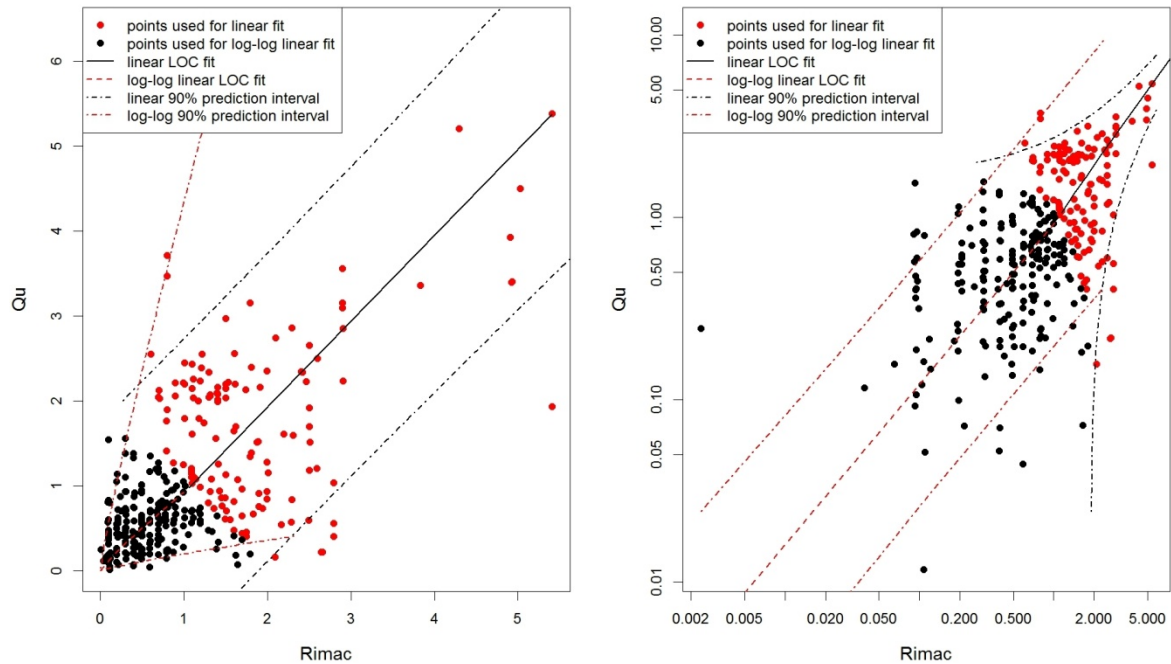

Figure C.2-1 Proposed Rimac- Q_u relation with approximate 90% confidence intervals plotted with linear axes (left) and log-log axes (right).

C.2.1 IDOT Historic Unconfined Compressive Strength and Rimac Data

The information in this section is a reproduction of Appendix A of Research Report No. FHWA-ITC-13-025 by [Straub et al. \(2013\)](#):

Four scatterplots of Rimac versus Q_u values from a dataset containing 366 data pairs were obtained from IDOT. Basic statistics were attached to each plot. The original IDOT plots and associated statistical analyses are included below. The second plot, titled “CLAYS”, is labeled as including clay and clay loam and contains 92 data points, according to the statistical analysis attached. The third plot, titled “SILTS”, is labeled as including “Silt, SiL, SiC, and SiCL” (assumed to designate silt, silt loam, silty clay, and silty clay loam, respectively, by comparison with the standard soil-texture triangle, e.g., Dingman 1994, p. 213) and includes 253 data points. The fourth plot, titled “SANDS”, is labeled as including “Sa, SaL, Sac, SaCL, and Loam” (assumed to designate sand, sandy loam, sandy clay, sand clay loam, and loam, respectively) and includes 21 data points. Because of the range of soil textures included in each plot, it is not surprising that the range of soil strengths represented in the plots is also rather wide. The terminology SANDS,

Geotechnical Manual

Appendix C Field Test Procedures and References

SILTS, and CLAYS is retained in this literature in referring to the plots for convenience; but, these titles are not to be taken literally with respect to the soil textures for many of the soil samples included.

The numerical data and textural classification on which these plots were based could not be retrieved. The USGS therefore digitized the data pairs from the plots and obtained a dataset with 325 total paired Q_u and Rimac values, along with a classification into the soil texture (sand, silt, or clay) for each data point. A comparison of the original and digitized datasets is provided in [Table C.2.1-1](#). It can be seen that most of the points from the SANDS and CLAYS plots were able to be digitized, and likewise the regression coefficients are quite similar. Somewhat fewer data were recovered from the SILTS plot, and the regression coefficients are somewhat different; but both the original intercept and slope are within or near the uncertainty band of the coefficient obtained from the digitized data (that is, the coefficient +/- its standard error). The all-data case is similar to the SILTS case. As a result, it was concluded that the number of points recovered and the similarity of the regression coefficients indicate that the digitized data provides a representative sample of the original data.

Plot Title	Original Data			Digitized Data		
	N	Slope of linear regression of Rimac vs. Q_u ("b coefficient")	Intercept of linear regression of Rimac vs. Q_u ("a coefficient")	N	Slope of linear regression of Rimac vs. Q_u +/- standard error	Intercept of linear regression of Rimac vs. Q_u +/- standard error
SANDS	21	0.3620	0.4909	20	0.3571 +/- 0.4021	0.4893 +/- 0.2022
SILTS	253	0.4740	0.4726	218	0.4446 +/- 0.0575	0.5319 +/- 0.0694
CLAYS	92	0.8116	0.3059	87	0.8262 +/- 0.0777	0.3258 +/- 0.1418
All data	366	0.6995	0.3848	325	0.6557 +/- 0.0440	0.3984 +/- 0.0604

(N = Number of data points)

Table C.2.1-1 Statistical properties of IDOT's original Q_u -Rimac dataset and the USGS digitized dataset

There is significant scatter in the plots showing the Rimac and Q_u soil strength estimates. These differences arise from many sources, of which the testing procedure is only one. The paired Q_u and Rimac values come from common sites, but they are from different soil samples obtained using different samplers. Along with the numerical and textural data not being retrieved, the location and timing of each sample could not be retrieved; and it is assumed that at least some of

Geotechnical Manual

Appendix C Field Test Procedures and References

the paired data could have been taken at different locations within the site and possibly at different times. The effect of the different samplers is an inherent difference in the Q_u and Rimac testing methods; however, sampling variability affects the analysis but would not affect a comparison of Q_u and Rimac measurements of the same soil sample. Therefore, sampling variability is adding an unknown amount of noise to the present comparison of Q_u and Rimac measurements. Although the texture (based on the grain-size distribution) is a fundamental property of soils, in the present context, it is not possible to recover the textural classification of the sample data beyond the three broad groupings described above; nor is it currently a routine operation to perform grain-size analyses from soil samples at bridge sites. Therefore, the relations between Q_u and Rimac presented here were developed based on the whole dataset.

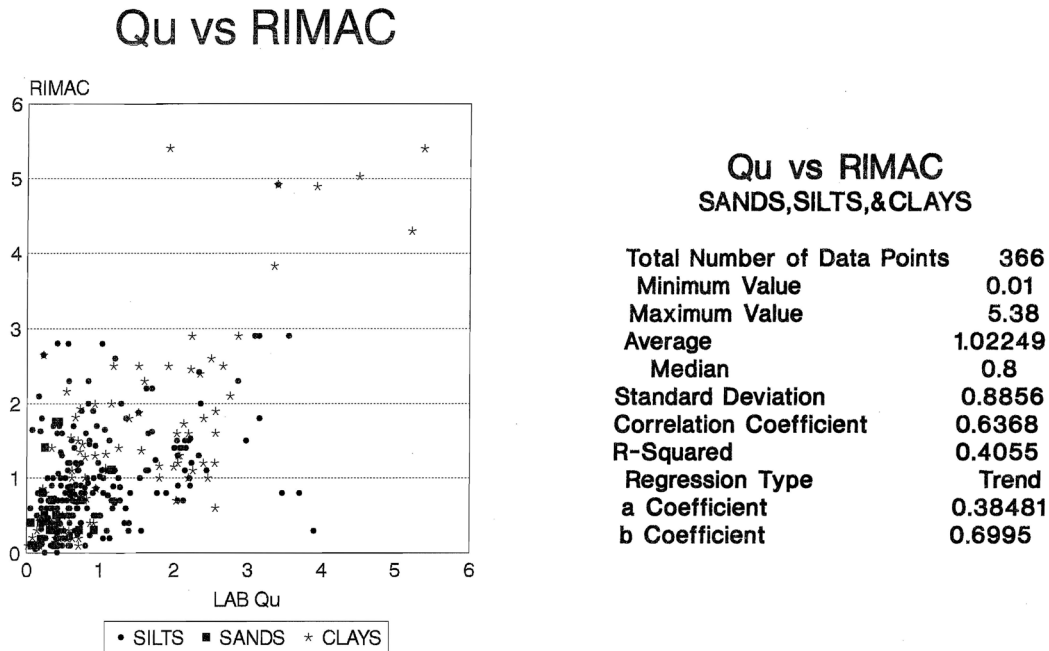

Figure C.2.1-1 Rimac- Q_u Relationship with Lab Q_u : “All data”

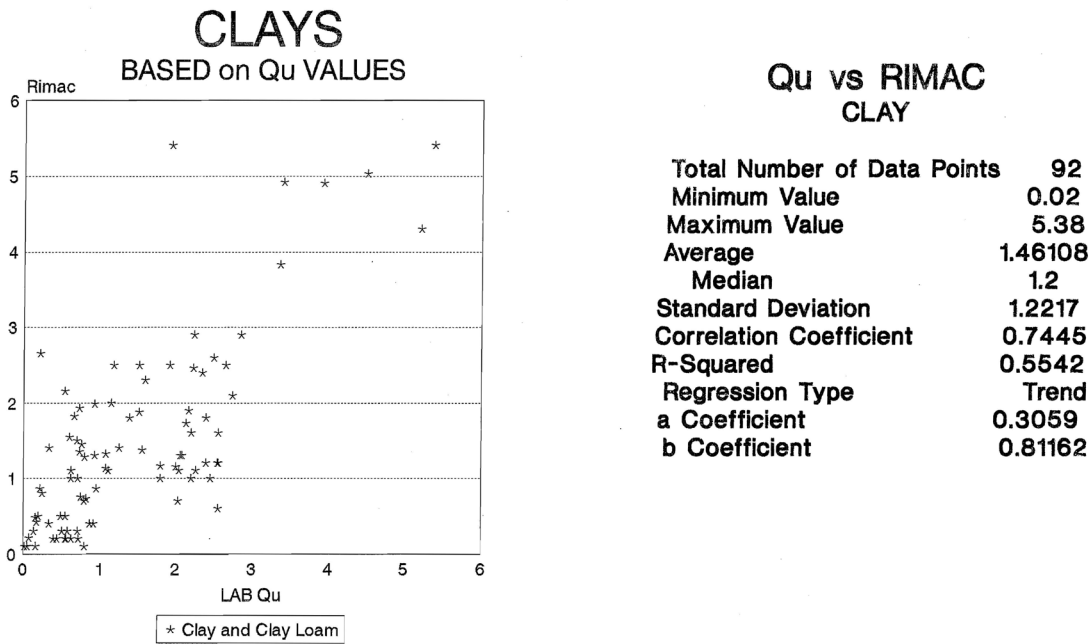

Figure C.2.1-2 RIMAC- Q_u Relationship with Lab Q_u : "CLAYS"

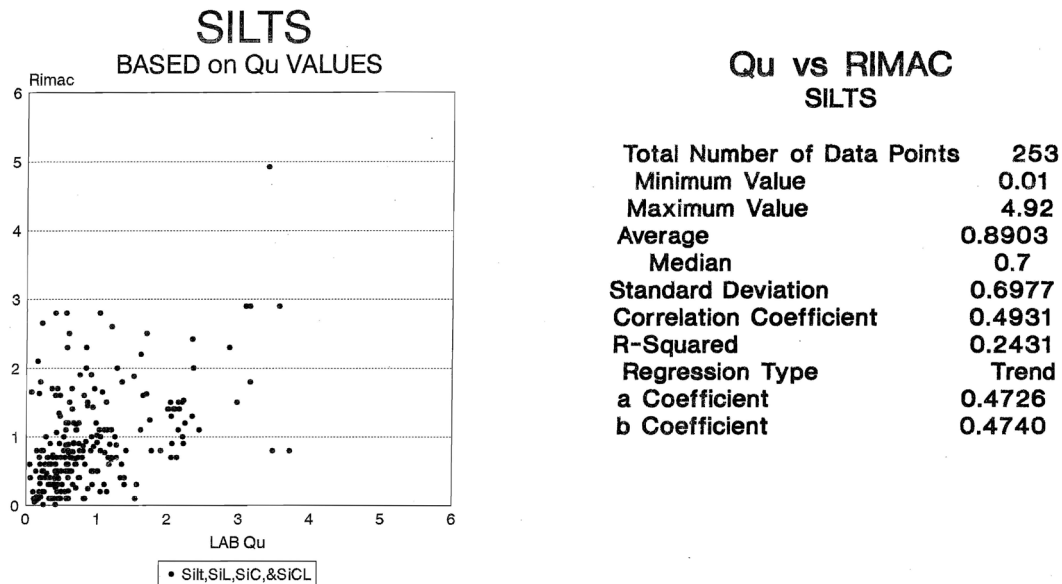

Figure C.2.1-3 RIMAC- Q_u Relationship with Lab Q_u : "SILTS"

Geotechnical Manual
Appendix C Field Test Procedures and References

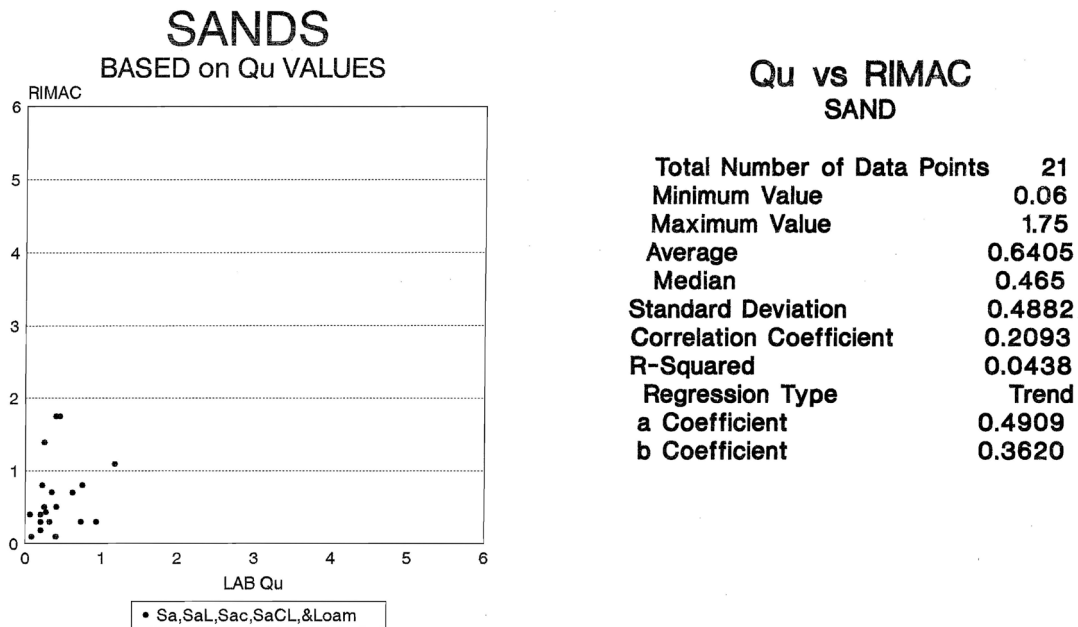

Figure C.2.1-4 Rimac- Q_u Relationship with Lab Q_u : “SANDS”

C.2.2 Unconfined Compressive Strength and Rimac Regression Details

The information in this section is a reproduction of Appendix B of Research Report No. FHWA-ITC-13-025 by [Straub et al. \(2013\)](#):

For reasons discussed below, a line-of-organic correlation (LOC) regression technique was chosen for use in developing the Q_u -Rimac relation. There is no known standard method for computing prediction intervals for LOC regression. The 90% prediction intervals shown in [Figure C.2-1](#) were computed with the following standard ordinary least squares (OLS) prediction interval equation (Helsel and Hirsch 2002, p. 241):

$$\left(y_0 - ts \sqrt{1 + \frac{1}{n} + \frac{(x_0 - \bar{x})^2}{SS_x}}, y_0 + ts \sqrt{1 + \frac{1}{n} + \frac{(x_0 - \bar{x})^2}{SS_x}} \right), \quad (\text{Eq. C.2.2-1})$$

Geotechnical Manual

Appendix C Field Test Procedures and References

where y_0 is the predicted y (Q_u) value when the Rimac value is x_0 , t is the value of the Student's t distribution having $n - 2$ degrees of freedom with an exceedance probability of 0.05, s is the standard error of regression, n is the number of data points used in the regression, \bar{x} is the mean of the x (Rimac) values, and $SS_x = \sum_{i=1}^n (x_i - \bar{x})^2$ is the x (Rimac) sum of squares. Values of all these quantities are given in [Table C.2-1](#), except for the value of the t distribution, which is a standard statistical distribution tabulated in many locations. As there are two prediction intervals shown in [Figure C.2-1](#), one each from the log-log and non-transformed regressions, the applicable lines to use for the prediction interval for a given Rimac value are the ones closer to the center, even if that means the prediction interval line from the log-log regression is used for one line and the non-transformed line is used for the other, as would be the case for Rimac near 1. As can be seen from the plots, the prediction intervals create an approximate envelope curve around the scatter of the data, with 7 of 130 red points and 19 of 195 black points lying outside, for a total of 26 of 325 or 8% lying outside. This percentage approximately matches the 10% that corresponds to the chosen 90% prediction interval, which corroborates the reasonableness of the method of computing them.

As mentioned, the linear fits presented here were computed using a regression procedure called the line of organic correlation (LOC), as implemented in the function *sma* from the *R* package *smatr* (Warton et al. 2012), where it is called the standardized major axis (SMA). The differences between the LOC and the most commonly used regression procedure, OLS, can be characterized in several ways. From a computational perspective, whereas OLS minimizes the sum of squared deviations of the y -axis values from the fitted line, the LOC minimizes the “sum of the areas of right triangles formed by horizontal and vertical lines extending from observations to the fitted line” (Helsel and Hirsch 2002, p. 277). The LOC slope also can be computed as the geometric mean of the slopes obtained by OLS regression of y on x and x on y . Both of these descriptions of the means of computing the LOC slope show that LOC takes into account errors in both variables and indeed treats both variables equivalently.

The LOC solution arises as the optimal linear fit when both the x - and y -variables have measurement and/or sampling errors (sometimes called an errors-in-variables model, Carroll and Ruppert 1996) under conditions that are symmetric in x and y in the following sense: when the ratio of the error variances (x -error over y -error) is equal to the ratio of the x -data variance to the y -data variance (Hirsch and Gilroy 1984). Although the errors in the Rimac and Q_u data are

Geotechnical Manual

Appendix C Field Test Procedures and References

unknown, the variance of the Rimac data are 0.8494, and the variance of the Q_u data are 0.8048; so their ratio is near one. If the Q_u measurement/sampling error plus the equation error (which is the error arising from the failure of the linear model to be exactly correct) is similar to the Rimac measurement error, then the error variance ratio would also be near one. Thus, the interpretation of the LOC solution of the Q_u versus Rimac relation as error-in-variables model seems plausible. The effect of the errors in the x-variable on the regression (if OLS regression were used) is to attenuate (that is, reduce the absolute value of) the slope estimate (Fuller 1987, chapter 1). In the present case, the OLS slope estimate for the log-transformed data with Rimac < 1.06 is 0.2214 and for the non-transformed data with Rimac > 1.06 it is 0.3953. As predicted, both are significantly smaller than the LOC slope estimates presented in [Table C.2-1](#).

Another difference between OLS and LOC fits is that predictions from the x-data using the OLS line reproduce the mean of the y-data and minimize the squared error of individual predictions with the result of underpredicting the variance of the y-data, whereas predictions from the x-data using the LOC line reproduce both the mean and the variance of the y-data. For this reason, LOC is often used to compute a relationship for use in extending hydrologic records (Helsel and Hirsch 2002, p. 277) by the so-called maintenance-of-variance-extension (MOVE) procedure (Hirsch 1982). The loss of variance in the predicted y-values in the case of the OLS fit would mean an underprediction of large values of Q_u and an overprediction of small values of Q_u for a given value of Rimac. From a practical point of view, this situation of attenuation of the predicted range of Q_u values was the primary reason for selecting the LOC approach to constructing the Q_u -Rimac relation proposed here.

Geotechnical Manual
Appendix C Field Test Procedures and References

C.3 Geotechnical Pile Resistance Tables

The data provided in the following tables should be used for the purpose of estimating the cumulative bearing of driven piles and evaluating the boring depth during the subsurface exploration. This data is not intended to be used for final design. Final design for the geotechnical pile resistance should be in accordance with [Section 6.13.2](#).

Geotechnical Manual

Appendix C Field Test Procedures and References

12 inch METAL SHELL GEOTECHNICAL PILE RESISTANCE																					
COHESIONLESS SOILS																					
N	Nominal Side Resistance																			Nominal Tip Resist.	
	Hard Till			Very Fine Silty Sand				Fine Sand			Medium Sand			Clean Coarse Sand			Sandy Gravel				
	Sample Interval		2.5 ft	5.0 ft	Sample Interval		2.5 ft	5.0 ft	Sample Interval		2.5 ft	5.0 ft	Sample Interval		2.5 ft	5.0 ft	Sample Interval		2.5 ft		5.0 ft
	(blows/ft)	(k/ft)			(kips)	(kips)			(k/ft)	(kips)			(kips)	(k/ft)			(kips)	(kips)			
2	0.3	0.7	1.5	0.4	1.1	2.1	0.5	1.2	2.3	0.5	1.2	2.5	0.5	1.3	2.7	0.5	1.4	2.7	6.2		
4	0.6	1.5	2.9	0.8	2.1	4.2	0.9	2.3	4.6	1.0	2.5	4.9	1.1	2.7	5.4	1.1	2.7	5.4	12.5		
6	0.9	2.2	4.4	1.3	3.2	6.3	1.4	3.5	6.9	1.5	3.7	7.4	1.6	4.0	8.1	1.6	4.1	8.1	18.7		
8	1.2	2.9	5.9	1.7	4.2	8.4	1.8	4.6	9.2	2.0	4.9	9.8	2.2	5.4	10.8	2.2	5.4	10.8	25.0		
10	1.5	3.7	7.4	2.1	5.3	10.5	2.3	5.8	11.6	2.5	6.1	12.3	2.7	6.7	13.4	2.7	6.8	13.5	31.2		
15	2.2	5.5	11.0	3.2	7.9	15.8	3.5	8.7	17.3	3.7	9.2	18.4	4.0	10.1	20.2	4.1	10.2	20.3	46.8		
20	2.9	7.4	14.7	4.2	10.5	21.0	4.6	11.6	23.1	4.9	12.3	24.6	5.4	13.4	26.9	5.4	13.5	27.1	62.4		
25	3.7	9.2	18.4	5.3	13.1	26.3	5.8	14.4	28.9	6.1	15.4	30.7	6.8	17.0	34.0	7.0	17.4	34.8	78.0		
30	4.4	11.0	21.9	6.3	15.8	31.6	7.0	17.5	34.9	7.7	19.3	38.6	8.8	22.0	43.9	9.3	23.2	46.3	93.6		
35	5.2	13.0	26.1	7.6	18.9	37.9	8.6	21.5	42.9	9.7	24.4	48.7	11.3	28.1	56.3	12.3	30.9	61.7	109		
40	6.2	15.5	31.0	9.0	22.5	45.0	10.6	26.6	53.2	12.2	30.5	61.0	14.2	35.5	71.0	16.6	41.5	83.0	125		
45	7.3	18.3	36.6	10.6	26.6	53.2	13.0	32.5	65.0	15.1	37.7	75.3	17.7	44.1	88.3	22.1	55.1	110	140		
50	8.6	21.5	42.9	12.5	31.2	62.4	15.6	38.9	77.8	18.4	45.9	91.8	21.6	54.0	108	27.5	68.8	138	156		
55	10.0	25.0	49.9	14.6	36.4	72.9	18.3	45.7	91.4	22.0	55.0	110	25.7	64.3	129	33.0	82.4	165	172		
60	11.5	28.8	57.7	16.9	42.2	84.5	21.1	52.8	106	25.7	64.4	129	29.9	74.7	149	38.4	96.1	192	187		
65	13.2	33.1	66.1	19.5	48.7	97.3	24.1	60.1	120	29.5	73.7	147	34.0	85.0	170	43.9	110	219	203		
70	15.1	37.7	75.3	22.3	55.7	111	27.6	68.9	138	33.2	83.1	166	38.1	95.3	191	49.4	123	247	218		
75	17.0	42.6	85.2	25.4	63.4	127	31.0	77.5	155	37.0	92.4	185	42.3	106	211	54.8	137	274	234		
80	19.2	47.9	95.8	28.5	71.2	142	34.5	86.2	172	40.7	102	203	46.4	116	232	60.3	151	301	250		
85	21.4	53.6	107	31.6	79.0	158	37.9	94.8	190	44.4	111	222	50.5	126	253	65.7	164	329	265		
90	23.8	59.6	119	34.7	86.8	174	41.4	103	207	48.2	120	241	54.7	137	273	71.2	178	356	281		
95	26.4	65.9	132	37.8	94.6	189	44.8	112	224	51.9	130	260	58.8	147	294	76.7	192	383	296		
100	29.1	72.7	145	41.0	102	205	48.3	121	241	55.7	139	278	63.0	157	315	82.1	205	411	312		

COHESIVE SOILS											
Q _u	Nominal Side Resist.				Nominal Tip Resist.	Q _u	Nominal Side Resist.				Nominal Tip Resist.
	(tsf)	Sample Interval		(kips)			(tsf)	Sample Interval		(kips)	
		(k/ft)	2.5 ft					5.0 ft	(k/ft)		
0.20	0.7	1.7	3.4	1.4	3.50	7.0	17.6	35.2	25.2		
0.40	1.3	3.3	6.5	2.9	4.00	7.8	19.5	39.0	28.8		
0.60	1.9	4.7	9.4	4.3	4.50	8.5	21.4	42.7	32.4		
0.80	2.4	6.1	12.1	5.8	5.00	8.5	21.4	42.7	36.0		
1.00	2.9	7.3	14.6	7.2	5.50	8.5	21.4	42.7	39.6		
1.20	3.4	8.4	16.8	8.6	6.00	8.5	21.4	42.7	43.2		
1.40	3.8	9.4	18.8	10.1	6.50	8.5	21.4	42.7	46.8		
1.60	4.1	10.3	20.7	11.5	7.00	8.5	21.4	42.7	50.4		
1.80	4.5	11.2	22.3	13.0	7.50	8.5	21.4	42.7	54.0		
2.00	4.8	12.0	23.9	14.4	8.00	8.5	21.4	42.7	57.6		
2.25	5.2	12.9	25.8	16.2	8.50	8.5	21.4	42.7	61.2		
2.50	5.5	13.8	27.7	18.0	9.00	8.5	21.4	42.7	64.8		
2.75	5.9	14.8	29.6	19.8	9.50	8.5	21.4	42.7	68.4		
3.00	6.3	15.7	31.4	21.6	Q _u >9.50	8.5	21.4	42.7	7.2*Q _u		

Table C.3-1 12 inch Metal Shell Geotechnical Pile Resistance

Geotechnical Manual

Appendix C Field Test Procedures and References

14 inch METAL SHELL GEOTECHNICAL PILE RESISTANCE																									
COHESIONLESS SOILS																									
N	Nominal Side Resistance																				Nominal Tip Resist.				
	Hard Till				Very Fine Silty Sand				Fine Sand				Medium Sand				Clean Coarse Sand					Sandy Gravel			
	Sample Interval		Sample Interval		Sample Interval		Sample Interval		Sample Interval		Sample Interval		Sample Interval		Sample Interval		Sample Interval								
	2.5 ft	5.0 ft	2.5 ft	5.0 ft	2.5 ft	5.0 ft	2.5 ft	5.0 ft	2.5 ft	5.0 ft	2.5 ft	5.0 ft	2.5 ft	5.0 ft	2.5 ft	5.0 ft	2.5 ft	5.0 ft							
(blows/ft)	(k/ft)	(kips)	(kips)	(k/ft)	(kips)	(kips)	(k/ft)	(kips)	(kips)	(k/ft)	(kips)	(kips)	(k/ft)	(kips)	(kips)	(k/ft)	(kips)	(kips)	(kips)						
2	0.3	0.8	1.7	0.5	1.2	2.4	0.5	1.3	2.6	0.6	1.4	2.8	0.6	1.5	3.1	0.6	1.5	3.1	8.4						
4	0.7	1.7	3.4	1.0	2.4	4.8	1.1	2.6	5.3	1.1	2.8	5.6	1.2	3.1	6.1	1.2	3.1	6.2	16.8						
6	1.0	2.5	5.0	1.4	3.6	7.2	1.6	4.0	7.9	1.7	4.2	8.4	1.8	4.6	9.2	1.9	4.6	9.3	25.2						
8	1.3	3.4	6.7	1.9	4.8	9.6	2.1	5.3	10.6	2.2	5.6	11.2	2.5	6.1	12.3	2.5	6.2	12.4	33.6						
10	1.7	4.2	8.4	2.4	6.0	12.0	2.6	6.6	13.2	2.8	7.0	14.0	3.1	7.7	15.4	3.1	7.7	15.5	42.0						
15	2.5	6.3	12.6	3.6	9.0	18.0	4.0	9.9	19.8	4.2	10.5	21.1	4.6	11.5	23.0	4.6	11.6	23.2	63.0						
20	3.4	8.4	16.8	4.8	12.0	24.0	5.3	13.2	26.4	5.6	14.0	28.1	6.1	15.4	30.7	6.2	15.5	31.0	84.0						
25	4.2	10.5	21.0	6.0	15.0	30.0	6.6	16.5	33.0	7.0	17.6	35.1	7.8	19.5	38.9	7.9	19.9	39.7	105						
30	5.0	12.5	25.1	7.2	18.1	36.2	8.0	19.9	39.9	8.8	22.1	44.1	10.0	25.1	50.2	10.6	26.5	52.9	126						
35	6.0	14.9	29.8	8.7	21.6	43.3	9.8	24.5	49.0	11.1	27.8	55.7	12.9	32.1	64.3	14.1	35.3	70.6	147						
40	7.1	17.7	35.4	10.3	25.7	51.4	12.2	30.4	60.8	13.9	34.8	69.7	16.2	40.6	81.2	19.0	47.4	94.8	168						
45	8.4	20.9	41.8	12.2	30.4	60.8	14.8	37.1	74.2	17.2	43.0	86.1	20.2	50.5	101	25.2	63.0	126	189						
50	9.8	24.5	49.0	14.3	35.7	71.4	17.8	44.5	88.9	21.0	52.5	105	24.7	61.7	123	31.4	78.6	157	210						
55	11.4	28.5	57.1	16.7	41.6	83.3	20.9	52.2	104	25.2	62.9	126	29.4	73.5	147	37.7	94.2	188	231						
60	13.2	33.0	65.9	19.3	48.3	96.6	24.1	60.4	121	29.4	73.6	147	34.1	85.3	171	43.9	110	220	252						
65	15.1	37.8	75.6	22.2	55.6	111	27.5	68.7	137	33.7	84.2	168	38.9	97.1	194	50.2	125	251	273						
70	17.2	43.0	86.1	25.5	63.7	127	31.5	78.7	157	38.0	94.9	190	43.6	109	218	56.4	141	282	294						
75	19.5	48.7	97.4	29.0	72.5	145	35.4	88.6	177	42.2	106	211	48.3	121	242	62.6	157	313	315						
80	21.9	54.7	109	32.5	81.4	163	39.4	98.5	197	46.5	116	233	53.0	133	265	68.9	172	344	336						
85	24.5	61.2	122	36.1	90.3	181	43.3	108	217	50.8	127	254	57.8	144	289	75.1	188	376	357						
90	27.2	68.1	136	39.7	99.2	198	47.3	118	236	55.1	138	275	62.5	156	312	81.4	203	407	378						
95	30.1	75.4	151	43.2	108	216	51.2	128	256	59.3	148	297	67.2	168	336	87.6	219	438	399						
100	33.2	83.1	166	46.8	117	234	55.2	138	276	63.6	159	318	72.0	180	360	93.8	235	469	420						

COHESIVE SOILS														
Q _u	Nominal Side Resist.				Nominal Tip Resist. (kips)	Use Hard Till Resistance when Q _u > 3.0 & N > 30	Q _u	Nominal Side Resist.				Nominal Tip Resist. (kips)		
	(tsf)	Sample Interval		(kips)				(k/ft)	(kips)	(k/ft)	Sample Interval		(kips)	
		2.5 ft	5.0 ft								2.5 ft			5.0 ft
0.20	0.8	2.0	3.9	2.0		3.50	8.1	20.4	40.7	34.7				
0.40	1.5	3.8	7.5	4.0		4.00	9.0	22.5	45.0	39.6				
0.60	2.2	5.5	10.9	5.9		4.50	9.9	24.7	49.4	44.6				
0.80	2.8	7.0	14.0	7.9		5.00	9.9	24.7	49.4	49.5				
1.00	3.4	8.4	16.9	9.9		5.50	9.9	24.7	49.4	54.5				
1.20	3.9	9.7	19.5	11.9		6.00	9.9	24.7	49.4	59.4				
1.40	4.4	10.9	21.8	13.9		6.50	9.9	24.7	49.4	64.4				
1.60	4.8	11.9	23.9	15.8		7.00	9.9	24.7	49.4	69.3				
1.80	5.2	12.9	25.8	17.8		7.50	9.9	24.7	49.4	74.3				
2.00	5.5	13.8	27.7	19.8		8.00	9.9	24.7	49.4	79.2				
2.25	6.0	14.9	29.8	22.3		8.50	9.9	24.7	49.4	84.2				
2.50	6.4	16.0	32.0	24.8		9.00	9.9	24.7	49.4	89.1				
2.75	6.8	17.1	34.2	27.2		9.50	9.9	24.7	49.4	94.1				
3.00	7.3	18.2	36.4	29.7		Q _u >9.50	9.9	24.7	49.4	9.9*Q _u				

Table C.3-2 14 inch Metal Shell Geotechnical Pile Resistance

Geotechnical Manual

Appendix C Field Test Procedures and References

16 inch METAL SHELL GEOTECHNICAL PILE RESISTANCE																									
COHESIONLESS SOILS																									
N	Nominal Side Resistance																				Nominal Tip Resist.				
	Hard Till				Very Fine Silty Sand				Fine Sand				Medium Sand				Clean Coarse Sand					Sandy Gravel			
	Sample Interval		Sample Interval		Sample Interval		Sample Interval		Sample Interval		Sample Interval		Sample Interval		Sample Interval		Sample Interval		Sample Interval						
	2.5 ft	5.0 ft	2.5 ft	5.0 ft	2.5 ft	5.0 ft	2.5 ft	5.0 ft	2.5 ft	5.0 ft	2.5 ft	5.0 ft	2.5 ft	5.0 ft	2.5 ft	5.0 ft	2.5 ft	5.0 ft	2.5 ft	5.0 ft					
(blows/ft)	(k/ft)	(kips)	(kips)	(k/ft)	(kips)	(kips)	(k/ft)	(kips)	(kips)	(k/ft)	(kips)	(kips)	(k/ft)	(kips)	(kips)	(k/ft)	(kips)	(kips)	(k/ft)	(kips)	(kips)				
2	0.4	0.9	1.9	0.5	1.4	2.7	0.6	1.5	3.0	0.6	1.6	3.2	0.7	1.7	3.5	0.7	1.7	3.5	0.7	1.7	3.5	10.8			
4	0.8	1.9	3.8	1.1	2.7	5.4	1.2	3.0	5.9	1.3	3.2	6.3	1.4	3.5	6.9	1.4	3.5	7.0	1.4	3.5	7.0	21.6			
6	1.1	2.8	5.7	1.6	4.1	8.1	1.8	4.5	8.9	1.9	4.7	9.5	2.1	5.2	10.4	2.1	5.2	10.4	2.1	5.2	10.4	32.4			
8	1.5	3.8	7.6	2.2	5.4	10.8	2.4	5.9	11.9	2.5	6.3	12.6	2.8	6.9	13.8	2.8	7.0	13.9	2.8	7.0	13.9	43.2			
10	1.9	4.7	9.5	2.7	6.8	13.5	3.0	7.4	14.9	3.2	7.9	15.8	3.5	8.6	17.3	3.5	8.7	17.4	3.5	8.7	17.4	54.0			
15	2.8	7.1	14.2	4.1	10.1	20.3	4.5	11.1	22.3	4.7	11.8	23.7	5.2	13.0	25.9	5.2	13.1	26.1	5.2	13.1	26.1	81.0			
20	3.8	9.5	18.9	5.4	13.5	27.0	5.9	14.9	29.7	6.3	15.8	31.6	6.9	17.3	34.6	7.0	17.4	34.8	7.0	17.4	34.8	108			
25	4.7	11.8	23.6	6.8	16.9	33.8	7.4	18.6	37.1	7.9	19.7	39.5	8.8	21.9	43.8	8.9	22.3	44.7	8.9	22.3	44.7	135			
30	5.6	14.1	28.2	8.1	20.3	40.7	9.0	22.4	44.9	9.9	24.8	49.6	11.3	28.2	56.5	11.9	29.8	59.5	11.9	29.8	59.5	162			
35	6.7	16.8	33.6	9.7	24.3	48.7	11.0	27.6	55.2	12.5	31.3	62.6	14.5	36.2	72.3	15.9	39.7	79.4	15.9	39.7	79.4	189			
40	8.0	19.9	39.8	11.6	28.9	57.9	13.7	34.2	68.4	15.7	39.2	78.4	18.3	45.7	91.3	21.3	53.3	107	21.3	53.3	107	216			
45	9.4	23.5	47.0	13.7	34.2	68.4	16.7	41.8	83.5	19.4	48.4	96.9	22.7	56.8	114	28.4	70.9	142	28.4	70.9	142	243			
50	11.0	27.6	55.2	16.1	40.1	80.3	20.0	50.0	100	23.6	59.0	118	27.8	69.4	139	35.4	88.4	177	35.4	88.4	177	270			
55	12.8	32.1	64.2	18.7	46.8	93.7	23.5	58.8	118	28.3	70.7	141	33.1	82.7	165	42.4	106	212	42.4	106	212	297			
60	14.8	37.1	74.2	21.7	54.3	109	27.2	67.9	136	33.1	82.8	166	38.4	96.0	192	49.4	124	247	49.4	124	247	324			
65	17.0	42.5	85.0	25.0	62.6	125	30.9	77.3	155	37.9	94.8	190	43.7	109	219	56.4	141	282	56.4	141	282	351			
70	19.4	48.4	96.8	28.7	71.6	143	35.4	88.6	177	42.7	107	214	49.0	123	245	63.5	159	317	63.5	159	317	378			
75	21.9	54.8	110	32.6	81.5	163	39.9	99.7	199	47.5	119	238	54.4	136	272	70.5	176	352	70.5	176	352	405			
80	24.6	61.6	123	36.6	91.5	183	44.3	111	222	52.3	131	262	59.7	149	298	77.5	194	387	77.5	194	387	432			
85	27.5	68.9	138	40.6	102	203	48.7	122	244	57.1	143	286	65.0	162	325	84.5	211	423	84.5	211	423	459			
90	30.6	76.6	153	44.6	112	223	53.2	133	266	61.9	155	310	70.3	176	352	91.5	229	458	91.5	229	458	486			
95	33.9	84.8	170	48.6	122	243	57.6	144	288	66.7	167	334	75.6	189	378	98.6	246	493	98.6	246	493	513			
100	37.4	93.4	187	52.7	132	263	62.1	155	310	71.6	179	358	80.9	202	405	106	264	528	106	264	528	540			

COHESIVE SOILS												
Q _u	Nominal Side Resist.				Nominal Tip Resist.	Use Hard Till Resistance when Q _u > 3.0 & N > 30	Q _u	Nominal Side Resist.				Nominal Tip Resist.
	Sample Interval		Sample Interval					Sample Interval		Sample Interval		
	2.5 ft	5.0 ft	2.5 ft	5.0 ft				2.5 ft	5.0 ft	2.5 ft	5.0 ft	
(tsf)	(k/ft)	(kips)	(kips)	(kips)	(kips)	(tsf)	(k/ft)	(kips)	(kips)	(kips)		
0.20	0.9	2.2	4.4	2.5		3.50	9.2	23.1	46.2	44.1		
0.40	1.7	4.3	8.6	5.0		4.00	10.2	25.6	51.1	50.4		
0.60	2.5	6.2	12.4	7.6		4.50	11.2	28.0	56.1	56.7		
0.80	3.2	8.0	15.9	10.1		5.00	11.2	28.0	56.1	63.0		
1.00	3.8	9.6	19.2	12.6		5.50	11.2	28.0	56.1	69.3		
1.20	4.4	11.1	22.1	15.1		6.00	11.2	28.0	56.1	75.6		
1.40	4.9	12.4	24.7	17.6		6.50	11.2	28.0	56.1	81.9		
1.60	5.4	13.6	27.1	20.2		7.00	11.2	28.0	56.1	88.2		
1.80	5.9	14.7	29.3	22.7		7.50	11.2	28.0	56.1	94.5		
2.00	6.3	15.7	31.4	25.2		8.00	11.2	28.0	56.1	100.8		
2.25	6.8	16.9	33.9	28.4		8.50	11.2	28.0	56.1	107.1		
2.50	7.3	18.2	36.3	31.5		9.00	11.2	28.0	56.1	113.4		
2.75	7.8	19.4	38.8	34.7		9.50	11.2	28.0	56.1	119.7		
3.00	8.3	20.6	41.3	37.8		Q _u >9.50	11.2	28.0	56.1	12.6*Q _u		

Table C.3-3 16 inch Metal Shell Geotechnical Pile Resistance

Geotechnical Manual

Appendix C Field Test Procedures and References

HP 8 GEOTECHNICAL PILE RESISTANCE																				
COHESIONLESS SOILS																				
N	Nominal Side Resistance																			Nominal Tip Resist.
	Hard Till		Very Fine Silty Sand		Fine Sand		Medium Sand		Clean Coarse Sand		Sandy Gravel		Sample Interval	Sample Interval	Sample Interval	Sample Interval	Sample Interval	Sample Interval	Sample Interval	
	2.5 ft	5.0 ft	2.5 ft	5.0 ft	2.5 ft	5.0 ft	2.5 ft	5.0 ft	2.5 ft	5.0 ft	2.5 ft	5.0 ft								
(blows/ft)	(k/ft)	(kips)	(kips)	(k/ft)	(kips)	(kips)	(k/ft)	(kips)	(kips)	(k/ft)	(kips)	(kips)	(k/ft)	(kips)	(kips)	(k/ft)	(kips)	(kips)	(kips)	
2	0.0	0.1	0.2	0.1	0.2	0.4	0.1	0.2	0.4	0.1	0.2	0.4	0.1	0.2	0.4	0.1	0.2	0.5	0.9	1.4
4	0.1	0.2	0.5	0.1	0.4	0.7	0.2	0.4	0.8	0.2	0.4	0.8	0.2	0.4	0.9	0.2	0.5	0.9	1.4	2.2
6	0.1	0.4	0.7	0.2	0.5	1.1	0.2	0.6	1.2	0.2	0.6	1.2	0.3	0.7	1.3	0.3	0.7	1.4	2.2	2.9
8	0.2	0.5	1.0	0.3	0.7	1.4	0.3	0.8	1.5	0.3	0.8	1.6	0.4	0.9	1.8	0.4	0.9	1.8	2.9	3.6
10	0.2	0.6	1.2	0.4	0.9	1.8	0.4	1.0	1.9	0.4	1.0	2.0	0.4	1.1	2.2	0.5	1.1	2.3	3.6	5.4
15	0.4	0.9	1.8	0.5	1.3	2.6	0.6	1.4	2.9	0.6	1.5	3.1	0.7	1.7	3.4	0.7	1.7	3.4	5.4	7.2
20	0.5	1.2	2.5	0.7	1.8	3.5	0.8	1.9	3.9	0.8	2.0	4.1	0.9	2.2	4.5	0.9	2.3	4.5	7.2	9.0
25	0.6	1.5	3.1	0.9	2.2	4.4	1.0	2.4	4.8	1.0	2.6	5.1	1.1	2.8	5.7	1.2	2.9	5.8	9.0	10.8
30	0.7	1.8	3.7	1.1	2.6	5.3	1.2	2.9	5.8	1.3	3.2	6.4	1.5	3.7	7.3	1.5	3.9	7.7	10.8	12.6
35	0.9	2.2	4.3	1.3	3.2	6.3	1.4	3.6	7.2	1.6	4.1	8.1	1.9	4.7	9.4	2.1	5.1	10.3	12.6	14.4
40	1.0	2.6	5.2	1.5	3.8	7.5	1.8	4.4	8.9	2.0	5.1	10.2	2.4	5.9	11.8	2.8	6.9	13.8	14.4	16.2
45	1.2	3.0	6.1	1.8	4.4	8.9	2.2	5.4	10.8	2.5	6.3	12.6	2.9	7.4	14.7	3.7	9.2	18.4	16.2	18.0
50	1.4	3.6	7.2	2.1	5.2	10.4	2.6	6.5	13.0	3.1	7.7	15.3	3.6	9.0	18.0	4.6	11.5	22.9	18.0	19.8
55	1.7	4.2	8.3	2.4	6.1	12.1	3.0	7.6	15.2	3.7	9.2	18.3	4.3	10.7	21.4	5.5	13.7	27.5	19.8	21.6
60	1.9	4.8	9.6	2.8	7.0	14.1	3.5	8.8	17.6	4.3	10.7	21.5	5.0	12.4	24.9	6.4	16.0	32.0	21.6	23.4
65	2.2	5.5	11.0	3.2	8.1	16.2	4.0	10.0	20.0	4.9	12.3	24.6	5.7	14.2	28.3	7.3	18.3	36.6	23.4	25.2
70	2.5	6.3	12.6	3.7	9.3	18.6	4.6	11.5	23.0	5.5	13.8	27.7	6.4	15.9	31.8	8.2	20.6	41.1	25.2	27.0
75	2.8	7.1	14.2	4.2	10.6	21.1	5.2	12.9	25.8	6.2	15.4	30.8	7.0	17.6	35.2	9.1	22.8	45.7	27.0	28.8
80	3.2	8.0	16.0	4.7	11.9	23.7	5.7	14.4	28.7	6.8	17.0	33.9	7.7	19.3	38.7	10.0	25.1	50.2	28.8	30.6
85	3.6	8.9	17.9	5.3	13.2	26.3	6.3	15.8	31.6	7.4	18.5	37.0	8.4	21.1	42.1	11.0	27.4	54.8	30.6	32.4
90	4.0	9.9	19.9	5.8	14.5	28.9	6.9	17.2	34.5	8.0	20.1	40.1	9.1	22.8	45.6	11.9	29.7	59.3	32.4	34.2
95	4.4	11.0	22.0	6.3	15.8	31.5	7.5	18.7	37.4	8.7	21.6	43.3	9.8	24.5	49.0	12.8	31.9	63.9	34.2	36.0
100	4.8	12.1	24.2	6.8	17.1	34.1	8.0	20.1	40.2	9.3	23.2	46.4	10.5	26.2	52.5	13.7	34.2	68.4	36.0	

COHESIVE SOILS										
Q _u	Nominal Side Resist.			Nominal Tip Resist.	Use Hard Till Resistance when Q _u > 3.0 & N > 30	Q _u	Nominal Side Resist.			Nominal Tip Resist.
	Q _u	Sample Interval					Q _u	Sample Interval		
		2.5 ft	5.0 ft					2.5 ft	5.0 ft	
(tsf)	(k/ft)	(kips)	(kips)	(kips)	(tsf)	(k/ft)	(kips)	(kips)	(kips)	
0.20	0.4	0.9	1.8	0.5	3.50	3.7	9.4	18.7	9.1	
0.40	0.7	1.7	3.5	1.0	4.00	4.1	10.3	20.7	10.4	
0.60	1.0	2.5	5.0	1.6	4.50	4.5	11.3	22.7	11.7	
0.80	1.3	3.2	6.4	2.1	5.00	4.5	11.3	22.7	13.1	
1.00	1.6	3.9	7.8	2.6	5.50	4.5	11.3	22.7	14.4	
1.20	1.8	4.5	8.9	3.1	6.00	4.5	11.3	22.7	15.7	
1.40	2.0	5.0	10.0	3.7	6.50	4.5	11.3	22.7	17.0	
1.60	2.2	5.5	11.0	4.2	7.00	4.5	11.3	22.7	18.3	
1.80	2.4	5.9	11.9	4.7	7.50	4.5	11.3	22.7	19.6	
2.00	2.5	6.4	12.7	5.2	8.00	4.5	11.3	22.7	20.9	
2.25	2.7	6.9	13.7	5.9	8.50	4.5	11.3	22.7	22.2	
2.50	2.9	7.4	14.7	6.5	9.00	4.5	11.3	22.7	23.5	
2.75	3.1	7.9	15.7	7.2	9.50	4.5	11.3	22.7	24.8	
3.00	3.3	8.4	16.7	7.8	Q _u >9.50	4.5	11.3	22.7	2.6*Q _u	

Table C.3-4 HP 8 Geotechnical Pile Resistance

Geotechnical Manual

Appendix C Field Test Procedures and References

HP 10 GEOTECHNICAL PILE RESISTANCE																					
COHESIONLESS SOILS																					
N	Nominal Side Resistance																			Nominal Tip Resist.	
	Hard Till			Very Fine Silty Sand				Fine Sand			Medium Sand			Clean Coarse Sand			Sandy Gravel				
	Sample Interval		2.5 ft	5.0 ft	Sample Interval		2.5 ft	5.0 ft	Sample Interval		2.5 ft	5.0 ft	Sample Interval		2.5 ft	5.0 ft	Sample Interval		2.5 ft		5.0 ft
	(blows/ft)	(k/ft)			(kips)	(kips)			(k/ft)	(kips)			(kips)	(k/ft)			(kips)	(kips)			
2	0.1	0.2	0.3	0.1	0.2	0.4	0.1	0.2	0.5	0.1	0.3	0.5	0.1	0.3	0.6	0.1	0.3	0.6	1.1		
4	0.1	0.3	0.6	0.2	0.4	0.9	0.2	0.5	1.0	0.2	0.5	1.0	0.2	0.6	1.1	0.2	0.6	1.1	2.2		
6	0.2	0.5	0.9	0.3	0.7	1.3	0.3	0.7	1.5	0.3	0.8	1.5	0.3	0.8	1.7	0.3	0.9	1.7	3.2		
8	0.2	0.6	1.2	0.4	0.9	1.8	0.4	1.0	1.9	0.4	1.0	2.1	0.5	1.1	2.3	0.5	1.1	2.3	4.3		
10	0.3	0.8	1.5	0.4	1.1	2.2	0.5	1.2	2.4	0.5	1.3	2.6	0.6	1.4	2.8	0.6	1.4	2.8	5.4		
15	0.5	1.2	2.3	0.7	1.7	3.3	0.7	1.8	3.6	0.8	1.9	3.9	0.8	2.1	4.2	0.9	2.1	4.3	8.1		
20	0.6	1.5	3.1	0.9	2.2	4.4	1.0	2.4	4.8	1.0	2.6	5.1	1.1	2.8	5.6	1.1	2.8	5.7	10.8		
25	0.8	1.9	3.9	1.1	2.8	5.5	1.2	3.0	6.1	1.3	3.2	6.4	1.4	3.6	7.1	1.5	3.6	7.3	13.5		
30	0.9	2.3	4.6	1.3	3.3	6.6	1.5	3.7	7.3	1.6	4.0	8.1	1.8	4.6	9.2	1.9	4.9	9.7	16.2		
35	1.1	2.7	5.5	1.6	4.0	7.9	1.8	4.5	9.0	2.0	5.1	10.2	2.4	5.9	11.8	2.6	6.5	12.9	18.9		
40	1.3	3.2	6.5	1.9	4.7	9.4	2.2	5.6	11.1	2.6	6.4	12.8	3.0	7.4	14.9	3.5	8.7	17.4	21.6		
45	1.5	3.8	7.7	2.2	5.6	11.1	2.7	6.8	13.6	3.2	7.9	15.8	3.7	9.2	18.5	4.6	11.6	23.1	24.3		
50	1.8	4.5	9.0	2.6	6.5	13.1	3.3	8.2	16.3	3.8	9.6	19.2	4.5	11.3	22.6	5.8	14.4	28.8	27.0		
55	2.1	5.2	10.5	3.1	7.6	15.3	3.8	9.6	19.2	4.6	11.5	23.1	5.4	13.5	27.0	6.9	17.3	34.5	29.7		
60	2.4	6.0	12.1	3.5	8.9	17.7	4.4	11.1	22.1	5.4	13.5	27.0	6.3	15.6	31.3	8.1	20.1	40.3	32.4		
65	2.8	6.9	13.9	4.1	10.2	20.4	5.0	12.6	25.2	6.2	15.4	30.9	7.1	17.8	35.6	9.2	23.0	46.0	35.1		
70	3.2	7.9	15.8	4.7	11.7	23.4	5.8	14.4	28.9	7.0	17.4	34.8	8.0	20.0	40.0	10.3	25.9	51.7	37.8		
75	3.6	8.9	17.9	5.3	13.3	26.6	6.5	16.2	32.5	7.7	19.4	38.7	8.9	22.1	44.3	11.5	28.7	57.4	40.5		
80	4.0	10.0	20.1	6.0	14.9	29.8	7.2	18.1	36.1	8.5	21.3	42.6	9.7	24.3	48.6	12.6	31.6	63.1	43.2		
85	4.5	11.2	22.4	6.6	16.5	33.1	7.9	19.9	39.7	9.3	23.3	46.6	10.6	26.5	53.0	13.8	34.4	68.9	45.9		
90	5.0	12.5	25.0	7.3	18.2	36.4	8.7	21.7	43.3	10.1	25.2	50.5	11.5	28.6	57.3	14.9	37.3	74.6	48.6		
95	5.5	13.8	27.6	7.9	19.8	39.6	9.4	23.5	47.0	10.9	27.2	54.4	12.3	30.8	61.6	16.1	40.2	80.3	51.3		
100	6.1	15.2	30.5	8.6	21.5	42.9	10.1	25.3	50.6	11.7	29.2	58.3	13.2	33.0	66.0	17.2	43.0	86.0	54.0		

COHESIVE SOILS															
Q _u	Nominal Side Resist.				Nominal Tip Resist.	Use Hard Till Resistance when Q _u > 3.0 & N > 30	Q _u	Nominal Side Resist.				Nominal Tip Resist.			
	(tsf)	(k/ft)	Sample Interval					(kips)	(kips)	(tsf)	(k/ft)		Sample Interval		(kips)
			2.5 ft	5.0 ft									2.5 ft	5.0 ft	
0.20	0.5	1.2	2.3	0.8		3.50	4.8	12.1	24.2	14.2					
0.40	0.9	2.2	4.5	1.6		4.00	5.4	13.4	26.8	16.2					
0.60	1.3	3.2	6.5	2.4		4.50	5.9	14.7	29.4	18.2					
0.80	1.7	4.2	8.3	3.2		5.00	5.9	14.7	29.4	20.3					
1.00	2.0	5.0	10.0	4.1		5.50	5.9	14.7	29.4	22.3					
1.20	2.3	5.8	11.6	4.9		6.00	5.9	14.7	29.4	24.3					
1.40	2.6	6.5	13.0	5.7		6.50	5.9	14.7	29.4	26.3					
1.60	2.8	7.1	14.2	6.5		7.00	5.9	14.7	29.4	28.4					
1.80	3.1	7.7	15.4	7.3		7.50	5.9	14.7	29.4	30.4					
2.00	3.3	8.2	16.4	8.1		8.00	5.9	14.7	29.4	32.4					
2.25	3.5	8.9	17.7	9.1		8.50	5.9	14.7	29.4	34.4					
2.50	3.8	9.5	19.0	10.1		9.00	5.9	14.7	29.4	36.5					
2.75	4.1	10.2	20.3	11.1		9.50	5.9	14.7	29.4	38.5					
3.00	4.3	10.8	21.6	12.2		Q _u >9.50	5.9	14.7	29.4	4.1*Q _u					

Table C.3-5 HP 10 Geotechnical Pile Resistance

Geotechnical Manual

Appendix C Field Test Procedures and References

HP 12 GEOTECHNICAL PILE RESISTANCE																				
COHESIONLESS SOILS																				
N	Nominal Side Resistance																			Nominal Tip Resist.
	Hard Till		Very Fine Silty Sand		Fine Sand		Medium Sand		Clean Coarse Sand		Sandy Gravel		Sample Interval	Sample Interval	Sample Interval	Sample Interval	Sample Interval	Sample Interval	Sample Interval	
	2.5 ft	5.0 ft	2.5 ft	5.0 ft	2.5 ft	5.0 ft	2.5 ft	5.0 ft	2.5 ft	5.0 ft	2.5 ft	5.0 ft								
(blows/ft)	(k/ft)	(kips)	(kips)	(k/ft)	(kips)	(kips)	(k/ft)	(kips)	(kips)	(k/ft)	(kips)	(kips)	(k/ft)	(kips)	(kips)	(k/ft)	(kips)	(kips)	(kips)	
2	0.1	0.2	0.4	0.1	0.3	0.5	0.1	0.3	0.6	0.1	0.3	0.6	0.1	0.3	0.7	0.1	0.3	0.7	1.6	
4	0.1	0.4	0.7	0.2	0.5	1.0	0.2	0.6	1.1	0.2	0.6	1.2	0.3	0.7	1.3	0.3	0.7	1.3	3.1	
6	0.2	0.5	1.1	0.3	0.8	1.6	0.3	0.9	1.7	0.4	0.9	1.8	0.4	1.0	2.0	0.4	1.0	2.0	4.7	
8	0.3	0.7	1.5	0.4	1.0	2.1	0.5	1.1	2.3	0.5	1.2	2.4	0.5	1.3	2.7	0.5	1.3	2.7	6.2	
10	0.4	0.9	1.8	0.5	1.3	2.6	0.6	1.4	2.9	0.6	1.5	3.0	0.7	1.7	3.3	0.7	1.7	3.4	7.8	
15	0.5	1.4	2.7	0.8	2.0	3.9	0.9	2.1	4.3	0.9	2.3	4.6	1.0	2.5	5.0	1.0	2.5	5.0	11.7	
20	0.7	1.8	3.6	1.0	2.6	5.2	1.1	2.9	5.7	1.2	3.0	6.1	1.3	3.3	6.7	1.3	3.4	6.7	15.6	
25	0.9	2.3	4.6	1.3	3.3	6.5	1.4	3.6	7.2	1.5	3.8	7.6	1.7	4.2	8.4	1.7	4.3	8.6	19.5	
30	1.1	2.7	5.4	1.6	3.9	7.8	1.7	4.3	8.6	1.9	4.8	9.6	2.2	5.4	10.9	2.3	5.7	11.5	23.4	
35	1.3	3.2	6.5	1.9	4.7	9.4	2.1	5.3	10.6	2.4	6.0	12.1	2.8	7.0	13.9	3.1	7.6	15.3	27.3	
40	1.5	3.8	7.7	2.2	5.6	11.1	2.6	6.6	13.2	3.0	7.5	15.1	3.5	8.8	17.6	4.1	10.3	20.5	31.2	
45	1.8	4.5	9.1	2.6	6.6	13.2	3.2	8.0	16.1	3.7	9.3	18.7	4.4	10.9	21.9	5.5	13.7	27.3	35.1	
50	2.1	5.3	10.6	3.1	7.7	15.5	3.9	9.6	19.3	4.5	11.4	22.7	5.3	13.4	26.7	6.8	17.0	34.1	39.0	
55	2.5	6.2	12.4	3.6	9.0	18.0	4.5	11.3	22.6	5.4	13.6	27.2	6.4	15.9	31.9	8.2	20.4	40.8	42.9	
60	2.9	7.1	14.3	4.2	10.5	20.9	5.2	13.1	26.2	6.4	15.9	31.9	7.4	18.5	37.0	9.5	23.8	47.6	46.8	
65	3.3	8.2	16.4	4.8	12.1	24.1	6.0	14.9	29.8	7.3	18.3	36.5	8.4	21.0	42.1	10.9	27.2	54.3	50.7	
70	3.7	9.3	18.6	5.5	13.8	27.6	6.8	17.1	34.1	8.2	20.6	41.1	9.4	23.6	47.2	12.2	30.6	61.1	54.6	
75	4.2	10.5	21.1	6.3	15.7	31.4	7.7	19.2	38.4	9.2	22.9	45.8	10.5	26.2	52.3	13.6	33.9	67.9	58.5	
80	4.7	11.9	23.7	7.1	17.6	35.3	8.5	21.3	42.7	10.1	25.2	50.4	11.5	28.7	57.5	14.9	37.3	74.6	62.4	
85	5.3	13.3	26.5	7.8	19.6	39.1	9.4	23.5	46.9	11.0	27.5	55.0	12.5	31.3	62.6	16.3	40.7	81.4	66.3	
90	5.9	14.8	29.5	8.6	21.5	43.0	10.2	25.6	51.2	11.9	29.8	59.6	13.5	33.9	67.7	17.6	44.1	88.1	70.2	
95	6.5	16.3	32.7	9.4	23.4	46.8	11.1	27.7	55.5	12.9	32.1	64.3	14.6	36.4	72.8	19.0	47.5	94.9	74.1	
100	7.2	18.0	36.0	10.1	25.4	50.7	12.0	29.9	59.8	13.8	34.5	68.9	15.6	39.0	77.9	20.3	50.8	102	78.0	

COHESIVE SOILS											
Q _u	Nominal Side Resist.			Nominal Tip Resist.	Use Hard Till Resistance when Q _u > 3.0 & N > 30	Q _u	Nominal Side Resist.			Nominal Tip Resist.	
	(tsf)	Sample Interval					(tsf)	(k/ft)	(kips)		(kips)
		2.5 ft	5.0 ft								
(k/ft)	(kips)	(kips)	(kips)	(kips)	(k/ft)	(kips)	(kips)	(kips)	(kips)		
0.20	0.5	1.4	2.7	1.2	3.50	5.7	14.3	28.6	20.5		
0.40	1.1	2.6	5.3	2.3	4.00	6.3	15.8	31.7	23.4		
0.60	1.5	3.8	7.7	3.5	4.50	6.9	17.4	34.7	26.3		
0.80	2.0	4.9	9.9	4.7	5.00	6.9	17.4	34.7	29.3		
1.00	2.4	5.9	11.9	5.9	5.50	6.9	17.4	34.7	32.2		
1.20	2.7	6.8	13.7	7.0	6.00	6.9	17.4	34.7	35.1		
1.40	3.1	7.7	15.3	8.2	6.50	6.9	17.4	34.7	38.0		
1.60	3.4	8.4	16.8	9.4	7.00	6.9	17.4	34.7	41.0		
1.80	3.6	9.1	18.2	10.5	7.50	6.9	17.4	34.7	43.9		
2.00	3.9	9.7	19.4	11.7	8.00	6.9	17.4	34.7	46.8		
2.25	4.2	10.5	21.0	13.2	8.50	6.9	17.4	34.7	49.7		
2.50	4.5	11.2	22.5	14.6	9.00	6.9	17.4	34.7	52.7		
2.75	4.8	12.0	24.0	16.1	9.50	6.9	17.4	34.7	55.6		
3.00	5.1	12.8	25.5	17.6	Q _u >9.50	6.9	17.4	34.7	5.9*Q _u		

Table C.3-6 HP 12 Geotechnical Pile Resistance

Geotechnical Manual

Appendix C Field Test Procedures and References

HP 14 GEOTECHNICAL PILE RESISTANCE																				
COHESIONLESS SOILS																				
N	Nominal Side Resistance																			Nominal Tip Resist.
	Hard Till			Very Fine Silty Sand				Fine Sand				Medium Sand			Clean Coarse Sand			Sandy Gravel		
	Sample Interval		2.5 ft	5.0 ft	Sample Interval		2.5 ft	5.0 ft	Sample Interval		2.5 ft	5.0 ft	Sample Interval		2.5 ft	5.0 ft	Sample Interval		2.5 ft	
(blows/ft)	(k/ft)	(kips)			(kips)	(k/ft)			(kips)	(kips)			(k/ft)	(kips)			(kips)	(k/ft)		(kips)
2	0.1	0.2	0.4	0.1	0.3	0.6	0.1	0.3	0.7	0.1	0.4	0.7	0.2	0.4	0.8	0.2	0.4	0.8	2.2	
4	0.2	0.4	0.9	0.2	0.6	1.2	0.3	0.7	1.3	0.3	0.7	1.4	0.3	0.8	1.6	0.3	0.8	1.6	4.3	
6	0.3	0.6	1.3	0.4	0.9	1.8	0.4	1.0	2.0	0.4	1.1	2.1	0.5	1.2	2.3	0.5	1.2	2.4	6.5	
8	0.3	0.9	1.7	0.5	1.2	2.4	0.5	1.3	2.7	0.6	1.4	2.9	0.6	1.6	3.1	0.6	1.6	3.1	8.6	
10	0.4	1.1	2.1	0.6	1.5	3.1	0.7	1.7	3.4	0.7	1.8	3.6	0.8	2.0	3.9	0.8	2.0	3.9	10.8	
15	0.6	1.6	3.2	0.9	2.3	4.6	1.0	2.5	5.0	1.1	2.7	5.4	1.2	2.9	5.9	1.2	3.0	5.9	16.2	
20	0.9	2.1	4.3	1.2	3.1	6.1	1.3	3.4	6.7	1.4	3.6	7.1	1.6	3.9	7.8	1.6	3.9	7.9	21.6	
25	1.1	2.7	5.3	1.5	3.8	7.6	1.7	4.2	8.4	1.8	4.5	8.9	2.0	4.9	9.9	2.0	5.0	10.1	27.0	
30	1.3	3.2	6.4	1.8	4.6	9.2	2.0	5.1	10.1	2.2	5.6	11.2	2.6	6.4	12.8	2.7	6.7	13.5	32.4	
35	1.5	3.8	7.6	2.2	5.5	11.0	2.5	6.2	12.5	2.8	7.1	14.2	3.3	8.2	16.3	3.6	9.0	17.9	37.8	
40	1.8	4.5	9.0	2.6	6.5	13.1	3.1	7.7	15.4	3.5	8.9	17.7	4.1	10.3	20.6	4.8	12.0	24.1	43.2	
45	2.1	5.3	10.6	3.1	7.7	15.4	3.8	9.4	18.9	4.4	10.9	21.9	5.1	12.8	25.6	6.4	16.0	32.0	48.6	
50	2.5	6.2	12.5	3.6	9.1	18.1	4.5	11.3	22.6	5.3	13.3	26.7	6.3	15.7	31.4	8.0	20.0	40.0	54.0	
55	2.9	7.3	14.5	4.2	10.6	21.2	5.3	13.3	26.6	6.4	16.0	32.0	7.5	18.7	37.4	9.6	23.9	47.9	59.4	
60	3.4	8.4	16.8	4.9	12.3	24.5	6.1	15.3	30.7	7.5	18.7	37.4	8.7	21.7	43.4	11.2	27.9	55.8	64.8	
65	3.8	9.6	19.2	5.7	14.1	28.3	7.0	17.5	34.9	8.6	21.4	42.8	9.9	24.7	49.4	12.7	31.9	63.7	70.2	
70	4.4	10.9	21.9	6.5	16.2	32.4	8.0	20.0	40.0	9.7	24.1	48.3	11.1	27.7	55.4	14.3	35.8	71.7	75.6	
75	4.9	12.4	24.7	7.4	18.4	36.8	9.0	22.5	45.0	10.7	26.8	53.7	12.3	30.7	61.4	15.9	39.8	79.6	81.0	
80	5.6	13.9	27.8	8.3	20.7	41.4	10.0	25.0	50.1	11.8	29.6	59.1	13.5	33.7	67.4	17.5	43.8	87.5	86.4	
85	6.2	15.6	31.1	9.2	22.9	45.9	11.0	27.5	55.1	12.9	32.3	64.5	14.7	36.7	73.4	19.1	47.7	95.5	91.8	
90	6.9	17.3	34.6	10.1	25.2	50.4	12.0	30.0	60.1	14.0	35.0	70.0	15.9	39.7	79.4	20.7	51.7	103	97.2	
95	7.7	19.2	38.3	11.0	27.5	54.9	13.0	32.6	65.1	15.1	37.7	75.4	17.1	42.7	85.4	22.3	55.7	111	103	
100	8.4	21.1	42.2	11.9	29.7	59.5	14.0	35.1	70.1	16.2	40.4	80.8	18.3	45.7	91.4	23.9	59.6	119	108	

COHESIVE SOILS												
Q _u	Nominal Side Resist.				Nominal Tip Resist.	Use Hard Till Resistance when Q _u > 3.0 & N > 30	Q _u	Nominal Side Resist.				Nominal Tip Resist.
	Q _u	Sample Interval		Q _u				Q _u	Sample Interval		Q _u	
		(tsf)	(k/ft)						(kips)	(kips)		
0.20	0.6	1.6	3.2	1.6		3.50	6.6	16.5	33.0	28.0		
0.40	1.2	3.1	6.1	3.2		4.00	7.3	18.3	36.5	32.0		
0.60	1.8	4.4	8.9	4.8		4.50	8.0	20.0	40.1	36.0		
0.80	2.3	5.7	11.4	6.4		5.00	8.0	20.0	40.1	40.1		
1.00	2.7	6.8	13.7	8.0		5.50	8.0	20.0	40.1	44.1		
1.20	3.2	7.9	15.8	9.6		6.00	8.0	20.0	40.1	48.1		
1.40	3.5	8.8	17.7	11.2		6.50	8.0	20.0	40.1	52.1		
1.60	3.9	9.7	19.4	12.8		7.00	8.0	20.0	40.1	56.1		
1.80	4.2	10.5	21.0	14.4		7.50	8.0	20.0	40.1	60.1		
2.00	4.5	11.2	22.4	16.0		8.00	8.0	20.0	40.1	64.1		
2.25	4.8	12.1	24.2	18.0		8.50	8.0	20.0	40.1	68.1		
2.50	5.2	13.0	26.0	20.0		9.00	8.0	20.0	40.1	72.1		
2.75	5.5	13.9	27.7	22.0		9.50	8.0	20.0	40.1	76.1		
3.00	5.9	14.7	29.5	24.0		Q _u >9.50	8.0	20.0	40.1	8.0*Q _u		

Table C.3-7 HP 14 Geotechnical Pile Resistance

Geotechnical Manual

Appendix C Field Test Procedures and References

HP 16 GEOTECHNICAL PILE RESISTANCE																				
COHESIONLESS SOILS																				
N	Nominal Side Resistance																			Nominal Tip Resist.
	Hard Till		Very Fine Silty Sand		Fine Sand		Medium Sand		Clean Coarse Sand		Sandy Gravel		Nominal Tip Resist.							
	Sample Interval	Sample Interval	Sample Interval	Sample Interval	Sample Interval	Sample Interval	Sample Interval	Sample Interval	Sample Interval	Sample Interval										
(blows/ft)	(k/ft)	(kips)	(kips)	(k/ft)	(kips)	(kips)	(k/ft)	(kips)	(kips)	(k/ft)	(kips)	(kips)	(k/ft)	(kips)	(kips)	(k/ft)	(kips)	(kips)	(kips)	
2	0.1	0.2	0.5	0.1	0.4	0.7	0.2	0.4	0.8	0.2	0.4	0.8	0.2	0.4	0.9	0.2	0.5	0.9	2.8	
4	0.2	0.5	1.0	0.3	0.7	1.4	0.3	0.8	1.5	0.3	0.8	1.6	0.4	0.9	1.8	0.4	0.9	1.8	5.5	
6	0.3	0.7	1.5	0.4	1.1	2.1	0.5	1.2	2.3	0.5	1.2	2.5	0.5	1.3	2.7	0.5	1.4	2.7	8.3	
8	0.4	1.0	2.0	0.6	1.4	2.8	0.6	1.5	3.1	0.7	1.6	3.3	0.7	1.8	3.6	0.7	1.8	3.6	11.0	
10	0.5	1.2	2.5	0.7	1.8	3.5	0.8	1.9	3.9	0.8	2.0	4.1	0.9	2.2	4.5	0.9	2.3	4.5	13.8	
15	0.7	1.8	3.7	1.1	2.6	5.3	1.2	2.9	5.8	1.2	3.1	6.1	1.3	3.4	6.7	1.4	3.4	6.8	20.7	
20	1.0	2.5	4.9	1.4	3.5	7.0	1.5	3.9	7.7	1.6	4.1	8.2	1.8	4.5	9.0	1.8	4.5	9.0	27.6	
25	1.2	3.1	6.1	1.8	4.4	8.8	1.9	4.8	9.6	2.0	5.1	10.2	2.3	5.7	11.3	2.3	5.8	11.6	34.5	
30	1.5	3.7	7.3	2.1	5.3	10.5	2.3	5.8	11.6	2.6	6.4	12.9	2.9	7.3	14.6	3.1	7.7	15.4	41.4	
35	1.7	4.3	8.7	2.5	6.3	12.6	2.9	7.2	14.3	3.2	8.1	16.2	3.8	9.4	18.8	4.1	10.3	20.6	48.3	
40	2.1	5.2	10.3	3.0	7.5	15.0	3.5	8.9	17.7	4.1	10.2	20.3	4.7	11.8	23.7	5.5	13.8	27.7	55.2	
45	2.4	6.1	12.2	3.5	8.9	17.7	4.3	10.8	21.7	5.0	12.6	25.1	5.9	14.7	29.4	7.4	18.4	36.8	62.1	
50	2.9	7.2	14.3	4.2	10.4	20.8	5.2	13.0	25.9	6.1	15.3	30.6	7.2	18.0	36.0	9.2	22.9	45.9	69.0	
55	3.3	8.3	16.6	4.9	12.1	24.3	6.1	15.2	30.5	7.3	18.3	36.7	8.6	21.4	42.9	11.0	27.5	55.0	75.9	
60	3.8	9.6	19.2	5.6	14.1	28.2	7.0	17.6	35.2	8.6	21.5	42.9	10.0	24.9	49.8	12.8	32.0	64.1	82.8	
65	4.4	11.0	22.0	6.5	16.2	32.4	8.0	20.0	40.1	9.8	24.6	49.1	11.3	28.3	56.7	14.6	36.6	73.2	89.7	
70	5.0	12.6	25.1	7.4	18.6	37.2	9.2	23.0	45.9	11.1	27.7	55.4	12.7	31.8	63.6	16.5	41.1	82.3	96.6	
75	5.7	14.2	28.4	8.5	21.1	42.3	10.3	25.8	51.7	12.3	30.8	61.6	14.1	35.2	70.5	18.3	45.7	91.4	104	
80	6.4	16.0	31.9	9.5	23.7	47.5	11.5	28.7	57.4	13.6	33.9	67.8	15.5	38.7	77.4	20.1	50.2	100	110	
85	7.1	17.9	35.7	10.5	26.3	52.7	12.6	31.6	63.2	14.8	37.0	74.1	16.8	42.1	84.2	21.9	54.8	110	117	
90	7.9	19.9	39.7	11.6	28.9	57.9	13.8	34.5	69.0	16.1	40.1	80.3	18.2	45.6	91.1	23.7	59.3	119	124	
95	8.8	22.0	44.0	12.6	31.5	63.1	14.9	37.4	74.7	17.3	43.3	86.5	19.6	49.0	98.0	25.6	63.9	128	131	
100	9.7	24.2	48.4	13.7	34.1	68.3	16.1	40.2	80.5	18.6	46.4	92.8	21.0	52.5	105	27.4	68.4	137	138	

COHESIVE SOILS												
Q _u	Nominal Side Resist.				Nominal Tip Resist.	Use Hard Till Resistance when Q _u > 3.0 & N > 30	Q _u	Nominal Side Resist.				Nominal Tip Resist.
	Sample Interval	Sample Interval	Sample Interval	Sample Interval				Sample Interval	Sample Interval			
										2.5 ft	5.0 ft	
(tsf)	(k/ft)	(kips)	(kips)	(kips)	(kips)	(tsf)	(k/ft)	(kips)	(kips)	(kips)		
0.20	0.7	1.8	3.7	2.1		3.50	7.7	19.3	38.5	36.5		
0.40	1.4	3.6	7.1	4.2		4.00	8.5	21.3	42.6	41.8		
0.60	2.1	5.2	10.3	6.3		4.50	9.3	23.4	46.7	47.0		
0.80	2.7	6.6	13.3	8.4		5.00	9.3	23.4	46.7	52.2		
1.00	3.2	8.0	16.0	10.4		5.50	9.3	23.4	46.7	57.4		
1.20	3.7	9.2	18.4	12.5		6.00	9.3	23.4	46.7	62.6		
1.40	4.1	10.3	20.6	14.6		6.50	9.3	23.4	46.7	67.9		
1.60	4.5	11.3	22.6	16.7		7.00	9.3	23.4	46.7	73.1		
1.80	4.9	12.2	24.4	18.8		7.50	9.3	23.4	46.7	78.3		
2.00	5.2	13.1	26.2	20.9		8.00	9.3	23.4	46.7	83.5		
2.25	5.6	14.1	28.2	23.5		8.50	9.3	23.4	46.7	88.7		
2.50	6.1	15.1	30.3	26.1		9.00	9.3	23.4	46.7	94.0		
2.75	6.5	16.2	32.3	28.7		9.50	9.3	23.4	46.7	99.2		
3.00	6.9	17.2	34.4	31.3		Q _u >9.50	9.3	23.4	46.7	10.5*Q _u		

Table C.3-8 HP 16 Geotechnical Pile Resistance

Geotechnical Manual

Appendix C Field Test Procedures and References

HP 18 GEOTECHNICAL PILE RESISTANCE																					
COHESIONLESS SOILS																					
N	Nominal Side Resistance																			Nominal Tip Resist.	
	Hard Till			Very Fine Silty Sand				Fine Sand			Medium Sand			Clean Coarse Sand			Sandy Gravel				
	Sample Interval		2.5 ft	5.0 ft	Sample Interval		2.5 ft	5.0 ft	Sample Interval		2.5 ft	5.0 ft	Sample Interval		2.5 ft	5.0 ft	Sample Interval		2.5 ft		5.0 ft
	(blows/ft)	(k/ft)			(kips)	(kips)			(k/ft)	(kips)			(kips)	(k/ft)			(kips)	(kips)			
2	0.1	0.3	0.5	0.2	0.4	0.8	0.2	0.4	0.9	0.2	0.5	0.9	0.2	0.5	1.0	0.2	0.5	1.0	3.5		
4	0.2	0.5	1.1	0.3	0.8	1.6	0.3	0.9	1.7	0.4	0.9	1.8	0.4	1.0	2.0	0.4	1.0	2.0	7.0		
6	0.3	0.8	1.6	0.5	1.2	2.3	0.5	1.3	2.6	0.5	1.4	2.7	0.6	1.5	3.0	0.6	1.5	3.0	10.4		
8	0.4	1.1	2.2	0.6	1.6	3.1	0.7	1.7	3.4	0.7	1.8	3.7	0.8	2.0	4.0	0.8	2.0	4.0	13.9		
10	0.5	1.4	2.7	0.8	2.0	3.9	0.9	2.1	4.3	0.9	2.3	4.6	1.0	2.5	5.0	1.0	2.5	5.0	17.4		
15	0.8	2.0	4.1	1.2	2.9	5.9	1.3	3.2	6.4	1.4	3.4	6.8	1.5	3.7	7.5	1.5	3.8	7.5	26.1		
20	1.1	2.7	5.5	1.6	3.9	7.8	1.7	4.3	8.6	1.8	4.6	9.1	2.0	5.0	10.0	2.0	5.0	10.1	34.8		
25	1.4	3.4	6.8	2.0	4.9	9.8	2.1	5.4	10.7	2.3	5.7	11.4	2.5	6.3	12.6	2.6	6.5	12.9	43.5		
30	1.6	4.1	8.1	2.4	5.9	11.8	2.6	6.5	13.0	2.9	7.2	14.3	3.3	8.2	16.3	3.4	8.6	17.2	52.2		
35	1.9	4.8	9.7	2.8	7.0	14.1	3.2	8.0	15.9	3.6	9.0	18.1	4.2	10.4	20.9	4.6	11.5	22.9	60.9		
40	2.3	5.8	11.5	3.3	8.4	16.7	3.9	9.9	19.7	4.5	11.3	22.6	5.3	13.2	26.4	6.2	15.4	30.8	69.6		
45	2.7	6.8	13.6	4.0	9.9	19.8	4.8	12.1	24.1	5.6	14.0	28.0	6.6	16.4	32.8	8.2	20.5	41.0	78.3		
50	3.2	8.0	15.9	4.6	11.6	23.2	5.8	14.4	28.9	6.8	17.1	34.1	8.0	20.0	40.1	10.2	25.5	51.1	87.0		
55	3.7	9.3	18.5	5.4	13.5	27.1	6.8	17.0	34.0	8.2	20.4	40.9	9.6	23.9	47.8	12.2	30.6	61.2	95.7		
60	4.3	10.7	21.4	6.3	15.7	31.4	7.8	19.6	39.2	9.6	23.9	47.8	11.1	27.7	55.5	14.3	35.7	71.4	104		
65	4.9	12.3	24.6	7.2	18.1	36.2	8.9	22.3	44.7	11.0	27.4	54.8	12.6	31.6	63.1	16.3	40.8	81.5	113		
70	5.6	14.0	28.0	8.3	20.7	41.4	10.2	25.6	51.2	12.3	30.8	61.7	14.2	35.4	70.8	18.3	45.8	91.7	122		
75	6.3	15.8	31.6	9.4	23.5	47.1	11.5	28.8	57.6	13.7	34.3	68.6	15.7	39.3	78.5	20.4	50.9	102	131		
80	7.1	17.8	35.6	10.6	26.4	52.9	12.8	32.0	64.0	15.1	37.8	75.6	17.2	43.1	86.2	22.4	56.0	112	139		
85	8.0	19.9	39.8	11.7	29.3	58.7	14.1	35.2	70.4	16.5	41.3	82.5	18.8	46.9	93.9	24.4	61.0	122	148		
90	8.9	22.1	44.3	12.9	32.2	64.5	15.4	38.4	76.8	17.9	44.7	89.5	20.3	50.8	102	26.4	66.1	132	157		
95	9.8	24.5	49.0	14.1	35.1	70.3	16.6	41.6	83.2	19.3	48.2	96.4	21.8	54.6	109	28.5	71.2	142	165		
100	10.8	27.0	54.0	15.2	38.0	76.1	17.9	44.8	89.7	20.7	51.7	103	23.4	58.5	117	30.5	76.2	152	174		

COHESIVE SOILS												
Q _u	Nominal Side Resist.				Nominal Tip Resist.	Use Hard Till Resistance when Q _u > 3.0 & N > 30	Q _u	Nominal Side Resist.				Nominal Tip Resist.
	(tsf)	(k/ft)	Sample Interval					(tsf)	(k/ft)	Sample Interval		
			2.5 ft	5.0 ft						2.5 ft	5.0 ft	
0.20	0.8	2.1	4.1	2.6		3.50	8.6	21.5	42.9	46.3		
0.40	1.6	4.0	7.9	5.3		4.00	9.5	23.7	47.5	52.9		
0.60	2.3	5.8	11.5	7.9		4.50	10.4	26.0	52.1	59.5		
0.80	3.0	7.4	14.8	10.6		5.00	10.4	26.0	52.1	66.2		
1.00	3.6	8.9	17.8	13.2		5.50	10.4	26.0	52.1	72.8		
1.20	4.1	10.3	20.5	15.9		6.00	10.4	26.0	52.1	79.4		
1.40	4.6	11.5	23.0	18.5		6.50	10.4	26.0	52.1	86.0		
1.60	5.0	12.6	25.2	21.2		7.00	10.4	26.0	52.1	92.6		
1.80	5.4	13.6	27.2	23.8		7.50	10.4	26.0	52.1	99.2		
2.00	5.8	14.6	29.2	26.5		8.00	10.4	26.0	52.1	106		
2.25	6.3	15.7	31.4	29.8		8.50	10.4	26.0	52.1	112		
2.50	6.7	16.9	33.7	33.1		9.00	10.4	26.0	52.1	119		
2.75	7.2	18.0	36.0	36.4		9.50	10.4	26.0	52.1	126		
3.00	7.7	19.2	38.3	39.7		Q _u >9.50	10.4	26.0	52.1	13.2*Q _u		

Table C.3-9 HP 18 Geotechnical Pile Resistance

Geotechnical Manual
Appendix C Field Test Procedures and References

This page left intentionally blank.

Appendix D Settlement Analysis Procedure

D.1 Scope

This procedure outlines only the calculation methods used at IDOT to estimate the total settlement (S) for one or more compressible layers; and the times required to reach 50% (t_{50}) and 90% (t_{90}) of S ; for the layers. The test procedure is not described, herein, since it is conducted according to AASHTO T 216.

D.2 Obtaining Data

Data is obtained by conducting the consolidation test, according to AASHTO T 216, on specimens from Shelby tube or other intact (relatively undisturbed) samples. At IDOT, the consolidation equipment is connected to an automated data acquisition system programmed to collect data on specimen height (H) at regular intervals, for 400 minutes per load increment. This time can be increased or decreased, depending on the test objectives or conditions. The automated system provides tabulated data for H at different times (t). The system also plots, for each load increment, H versus $\log t$ (log-fitting) on one graph, and H versus square root of t (square root-fitting) on another graph.

D.3 Units

This settlement analysis procedure uses both English and the International System of Units (SI). At present, a soft conversion of the final data is reported where the SI units are required.

D.4 General Guidelines

The settlement calculation is based on the assumption that the specimen is fully saturated at the beginning of the test. Therefore, some error is anticipated for partially saturated specimens. To minimize such error, only specimens with high moisture contents (near saturation) should be tested for consolidation. Also, the graphical procedures require subjective judgment.

Geotechnical Manual

Appendix D Settlement Analysis Procedure

The values of S , t_{50} , and t_{90} , for one compressible layer, can be determined by using either the log-fitting or square root-fitting method. Since the value of H is the same at any time, regardless of what method is used, the choice of curve fitting method depends on how well the values of H versus t plot to make a “typical” fitting curve in either method. Therefore, the choice of one fitting method will depend primarily on the shape and quality of the fitting curve, and not the theoretical validity of one method versus the other.

Usually, a typical log-fitting curve is a reversed S-curve, with two linear portions and an inflection point ([Figure D.5-1](#)).

A square root-fitting curve is, typically, a hyperbolic curve with an initial straight line portion ([Figure D.6-1](#)).

Depending on the lab data, the drawing scale, and soil type, the shape of either curve could deviate from the “typical” shapes shown on [Figures D.5-1](#) and [D.6-1](#). Good judgment is important for choosing either fitting method and applying the standard procedure, described herein, to the appropriate curve. Fitting methods should be selected on the basis of their ability to satisfy the procedures outlined below. Where both log-fitting and square root-fitting curves are acceptable, the log-fitting curve should be considered the default-fitting method.

D.5 Log-Fitting Procedure

The log-fitting procedure is based on the Casagrande method for obtaining the specimen heights: H_0 , H_{50} , and H_{100} ; at 0%, 50%, and 100% consolidation, respectively. For graphical construction of these points, refer to [Figure D.5-1](#), and follow the procedure below. Proceed to the square root-fitting procedure if there is significant scatter in the log-fitting data, or if the procedures described below cannot be followed with confidence.

- (a) **Determine H_{100} :** If the upper portion of the log-fitting curve is a straight line on a load increment’s sample height (H) deformation readings versus log time graph, determine the H_{100} as follows. Draw a tangent downward from the point of inflection of the primary portion of the curve. Also, draw a tangent to the left of the lower, straight line portion of the curve. The point where the two tangents intersect corresponds to H_{100} for that increment.

Geotechnical Manual
Appendix D Settlement Analysis Procedure

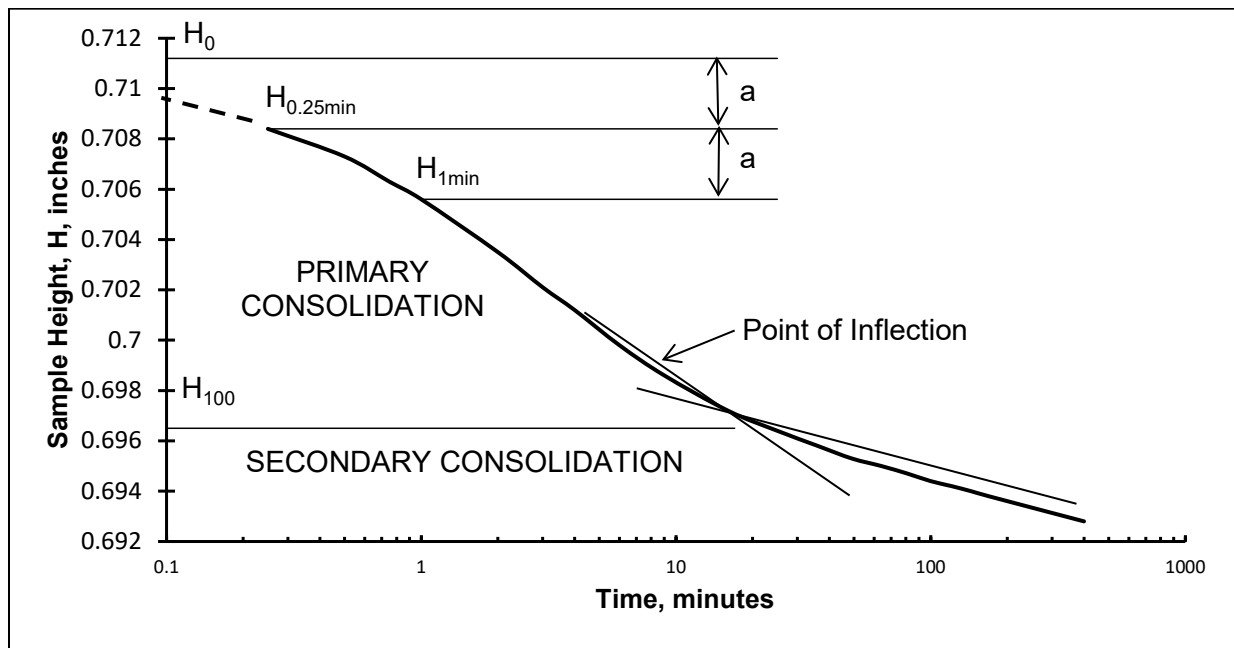

Figure D.5-1 Log-Fitting Determination of 0% and 100% Consolidation

- (b) Obtain the specimen height at the 0.25-minute reading ($H_{0.25\text{min}}$). Divide $(H_{100} + H_{0.25\text{min}})$ by 2 and note the corresponding time (t_1). If t_1 is greater than 1 minute, determine H_0 following the procedure in (c) below.

However, if t_1 is less than 1 minute, the log-fitting procedure should not be used. H_0 should be determined using data points located where less than one-half of the consolidation, for a particular load increment, has occurred. The H_0 from a log-fitting curve, with a straight line upper portion, is an approximation.

- (c) **Determine the initial specimen height, H_0 :** Draw the difference “a” in sample height between the 1-minute ($H_{1\text{min}}$) and 0.25-minute readings ($H_{0.25\text{min}}$). Project the difference “a” from the 0.25-minute readings ($H_{0.25\text{min}}$) upward to determine H_0 . If the vertical scale does not accommodate this procedure, subtract the specimen height at the 1-minute reading ($H_{1\text{min}}$) from 2 times the specimen height at the 0.25-minute reading; i.e. $(H_0 = 2H_{0.25\text{min}} - H_{1\text{min}})$.

Geotechnical Manual

Appendix D Settlement Analysis Procedure

- (d) (OPTIONAL) Calculate H_{50} by averaging H_{100} and H_0 :

$$H_{50} = \frac{H_0 + H_{100}}{2} \quad (\text{Eq. D.5-1})$$

Project H_{50} onto the curve and down to the log of time scale. That point corresponds to the t_{50} .

D.6 Square Root-Fitting Procedure

Refer to [Figure D.6-1](#) and follow the procedure below, to determine the H_0 , H_{50} , and H_{100} from the square-root-fitting curve.

- (a) On a load increment's sample height (H) deformation readings verses square root of time (\sqrt{t}) graph, extend the initial straight line portion of the curve upward to intersect the H -axis at point "**a**", which corresponds to H_0 . Extend the same line downward to intersect the \sqrt{t} - axis at point "**b**".
- (b) Measure the distance " x " along the \sqrt{t} - axis, from the origin to point "**b**". Multiply " x " by 1.15 to obtain "**c**". Connect points "**c**" and "**a**" with a straight line. The specimen height at 90% consolidation (H_{90}) is the point where the line "**ac**" intersects the curve.
- (c) Calculate H_{100} , using the following equation:

$$H_{100} = H_{90} - \frac{H_0 - H_{90}}{9} \quad (\text{Eq. D.6-1})$$

- (d) (OPTIONAL) Average H_{100} and H_0 to determine H_{50} using [Eq. D.5-1](#).
- (e) (OPTIONAL) Project H_{90} onto the original curve, and then down to the \sqrt{t} - axis. Square the value at that point to determine t_{90} .

Geotechnical Manual
Appendix D Settlement Analysis Procedure

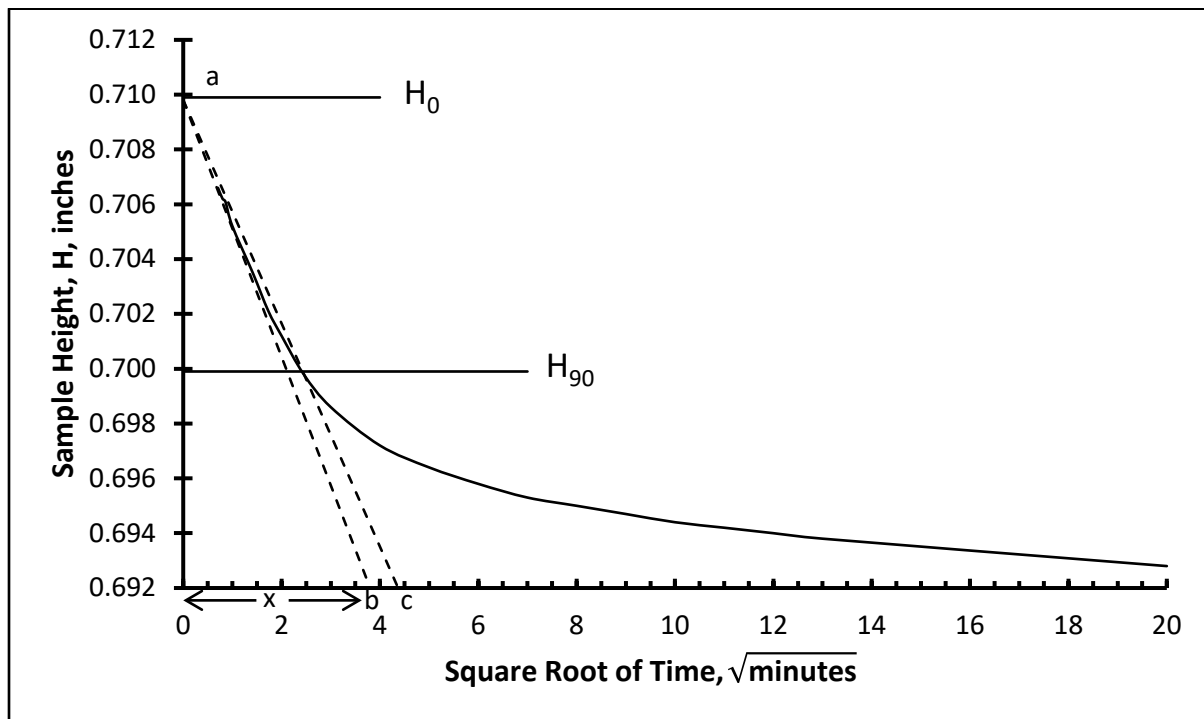

Figure D.6-1 Square Root-Fitting Determination of 0% and 100% Consolidation

D.7 Determining the Coefficient of Consolidation (c_v)

As a minimum, calculate c_v for two load increments: one immediately less than, and one immediately greater than the final effective vertical pressure at the center the layer (P'_f). The procedure for calculating P'_f is discussed in the next section. Select the fitting method, for those two load increments, which most represents the typical curve. The fitting method used to determine the c_v does not have to be the same as the method used to determine the H_{100} in [Appendix D.9.1.2](#). If both fitting methods are acceptable, use the log-fitting method.

For the log-fitting method, calculate c_v for a load increment, using the following equation:

$$c_v = \frac{[0.5 \times (H_{50} + MD)]^2}{t_{50}} T_{50} \quad (\text{Eq. D.7-1})$$

Geotechnical Manual

Appendix D Settlement Analysis Procedure

Where:

MD = Machine Deflection (obtained by calibration or provided by the manufacturer)

$T_{50} = 0.197$

c_v should be in the form of $c_v \times 10^{-4}$ in.²/min.

H_{50} and t_{50} are determined using the steps marked "OPTIONAL" in the fitting procedures ([Appendix D.5](#)).

For the square root-fitting method, calculate c_v for a load increment, using the following equation:

$$c_v = \frac{[0.5 \times (H_{50} + MD)]^2}{t_{90}} T_{90} \quad (\text{Eq. D.7-2})$$

Where:

$T_{90} = 0.848$

H_{50} and t_{90} are determined using the steps marked "OPTIONAL" in the fitting procedures ([Appendix D.6](#)).

Note: One-half of the corrected H_{50} is used because of the double drainage condition which exists under lab testing conditions for both [Equations D.7-1](#) and [D.7-2](#).

(OPTIONAL) Calculate c_v for each load increment (excluding the unload-reload increments) and plot the c_v versus log P data graphically in combination with the void ratio versus log P plot ([Figure D.9.1-1](#)) presented in [Appendix D.9.1](#).

Geotechnical Manual

Appendix D Settlement Analysis Procedure

D.8 Determining the Effective Overburden and Applied Pressures

Select appropriate compressible layers using the Shelby tube data sheets. One consolidation test should be included in each layer. In selecting layers, use sample description, wet unit weight, compressive strength, and moisture content as a guide. Calculate the average wet unit weight, γ_{avg} , of each layer. Calculate the effective overburden pressure, P'_o (in tsf), acting at the center of each compressible layer, using the sample diagram in [Figure D.8-1](#).

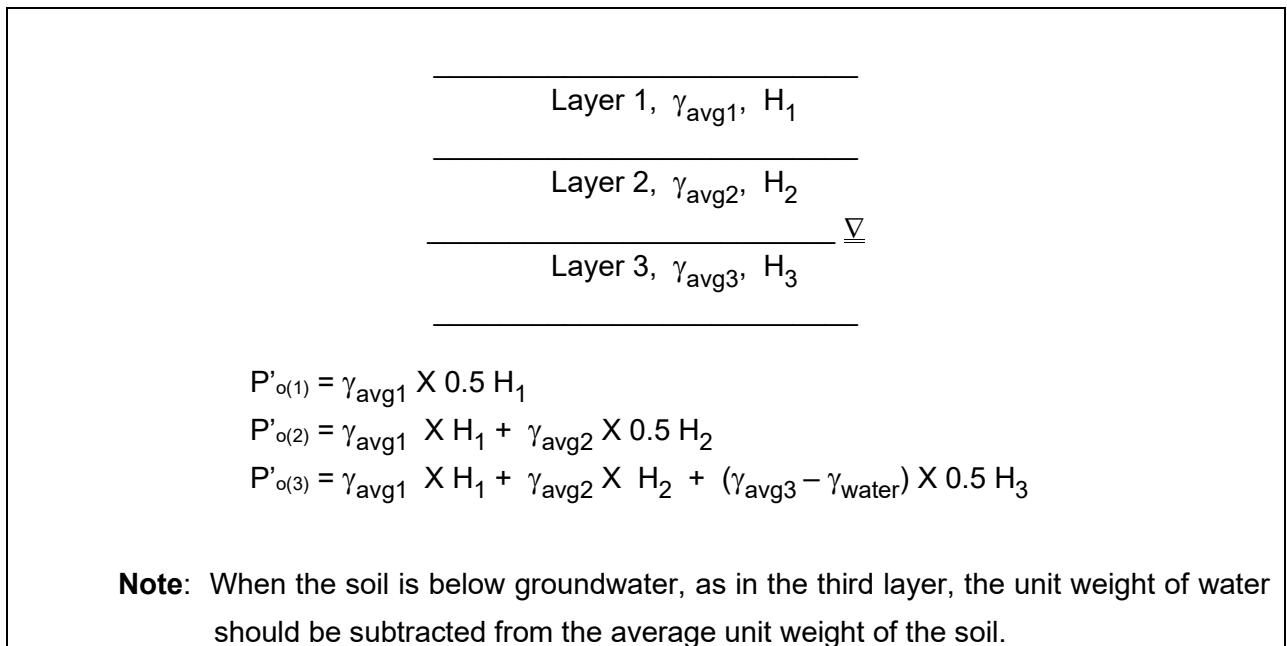

Figure D.8-1 Example of Effective Overburden Pressure (P'_o) Calculation

Calculate the applied pressure, $\Delta P'$ (in tsf), corresponding to the height of the proposed fill [125 pcf x fill height (ft.)/2,000], or the foundation pressure being applied to the compressible layers. This method determines $\Delta P'$ at the centerline of an embankment or foundation. If the embankment or foundation width is less than the depth to the center of the compressible layer, or if the settlement is required at a location other than the centerline, the value of $\Delta P'$ should be multiplied by a reduction factor or influence value (I) to account for the Boussinesq vertical stress distribution. The influence value (I) is determined, using the following equation by Osterberg (1957):

$$I = \frac{(A) \tan^{-1}(B) - \left(\frac{b}{a}\right) \tan^{-1}\left(\frac{b}{z}\right)}{\pi} \quad (\text{Eq. D.8-1})$$

Geotechnical Manual

Appendix D Settlement Analysis Procedure

Where:

$$A = \frac{a + b}{a}$$

$$B = \frac{a + b}{z}$$

a, b, and z are as defined in [Table D.8-1](#)

Angle units are radians

[Table D.8-1](#) presents several examples on how to use the Influence Chart. The final effective vertical pressure at the center of each layer is $P'_f = (P'_o + \Delta P')$.

Geotechnical Manual

Appendix D Settlement Analysis Procedure

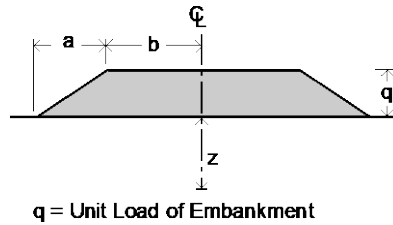

	<p>Use $a/z=1$ and $b/z=0.5$ to find the influence on the left; $I = 0.397$. Use $a/z=1$ and $b/z=1.5$ to find the influence on the right; $I = 0.478$. The total influence value is $0.397+0.478=0.875$. The vertical stress is then $0.875q$.</p>
	<p>Find the influence value for the dashed and solid portions ($a/z=1$, $b/z=4$, $I=0.499$). Subtract the influence value for the dashed portion ($a/z=1$, $b/z=1$, $I=0.455$). The vertical stress is then $0.044q$</p>
	<p>The stress due to wedge abc is the same as that due to wedge cde. Since the two would cancel, the stress is the same as if the embankment were vertical at b. Therefore, ($a/z=1$, $b/z=2.5$, $I=0.492$) the stress is $0.492q$.</p>
	<p>For calculating the stress under a strip load, $a/z=0 \sim a/z=0.1$. Use $b/z = 0.5$ to find the influence value to the left: $I=0.278$. Use $b/z=1.0$ to find the influence value to the right: $I=0.410$. The resulting vertical stress is then $0.688q$.</p>
	<p>For calculating the stress under the center of a triangular load, use $b/z=0$, $a/z=1$. I for both the left and right sides is 0.25. The resulting vertical stress is $0.5q$.</p>
	<p>In this case, the influence value for the vertical stress at a point other than the center of a triangular load = $0.25(0.08)+0.434 - 0.75(0.203)$. The resulting vertical stress is $0.302q$.</p>

Table D.8-1 Examples of the Use of the Influence Chart (Osterberg, 1957)

Geotechnical Manual

Appendix D Settlement Analysis Procedure

D.9 Primary Settlement Calculations

D.9.1 Void Ratio Verses Log Pressure (e-log P) Curve Development

D.9.1.1 Determine Volume of Solids

Assuming the specimen is fully saturated, determine the volume of solids, V_s , in the specimen after consolidation using ($V_s = V_{\text{final}} - V_w$). Calculate V_{final} using the sample height at the end of the consolidation test (plus the machine deflection correction). V_w is calculated using the mass of water in the specimen, after consolidation, and the water density as 1 g/cm³. For partially saturated specimens, which gain weight during the consolidation test, $V_s = W_s/G_s$, where: W_s = mass of solids and G_s = specific gravity of solids. V_s is constant for all load increments within a layer.

D.9.1.2 Calculate Void Ratio for Each Load Increment

After determining V_s , use [$H_{100} + \text{MD}$] and the specimen diameter to calculate the volume “V” of the specimen for each load increment. Do not mix H_{100} values from both the log-fitting and square root-fitting methods within a layer. Also, determine “V” for the specimen, prior to consolidation ($P=0$). Calculate the void ratio “e” for each load increment using: [$e = V/V_s - 1$]. The initial void ratio “ e_o ” can be calculated using the volume of the specimen, prior to consolidation ($P=0$).

D.9.1.3 Plot Laboratory Compression Data Curve

Plot “e” versus “P” on a 3-cycle semi-logarithmic paper (as shown in [Figure D.9.1-1](#)), where “P” is the pressure corresponding to the load applied to the specimen, during each increment. A sufficient number of load increments are needed to define the recompression and compression portions of the e-log P curve. Using the same semi-log paper, also plot the values of c_v versus log P, for the two load increments bounding P'_f (as a minimum), and draw a line connecting the two ([Appendix D.7](#)). However, it is preferable to plot the values of c_v versus log P for all load increments with the exclusion of any unload-reload increments.

Geotechnical Manual

Appendix D Settlement Analysis Procedure

D.9.1.4 Develop Field “Virgin” Curve

There is always a possibility of excessive soil disturbance during sampling and transportation to the laboratory. Casagrande’s graphical procedure (Peck et al., 1973) is used for determining the maximum effective overburden pressure (P'_{max}) that has been placed on the soil, at some point in geologic time. (P'_{max} is also known as the preconsolidation pressure in AASHTO T 216.) Schmertmann’s method (Terzaghi et al., 1996) is used for reconstructing the field “virgin” curve that represents the actual soil condition in the field, with no sample disturbance. The graphical reconstruction of the virgin “curve” from the lab curve is illustrated in [Figure D.9.1-1](#), and is summarized as follows:

- (a) After plotting the lab data points, extend the straight line portion of the lab curve down to $0.4 \times e_o$ at point (A).
- (b) Locate the point (B) of greatest curvature.
- (c) At point (B), draw a horizontal line (BC) and a tangent line (BD) to the e-log P curve.
- (d) Draw a line (BE), bisecting lines (BC) and (BD).
- (e) Extend the lower straight line portion of the e-log P curve upwards, until it intersects line (BE), at point (F).
- (f) From point (F), draw a vertical line up (or down) to intersect the log P axis at a certain point. This point corresponds to (P'_o). If P'_o is greater than P'_{max} , skip to step (j).
- (g) (OPTIONAL) If a partial unload-reload sequence has been performed, draw an average slope of recompression line for the unload-reload data points.
- (h) Draw a horizontal line from e_o to P'_o . Then draw a line parallel to the recompression portion of the lab e-log P curve [step (g)], from P'_o to the vertical line corresponding to P'_{max} (point H). Then connect points (A) and (H).

Geotechnical Manual
Appendix D Settlement Analysis Procedure

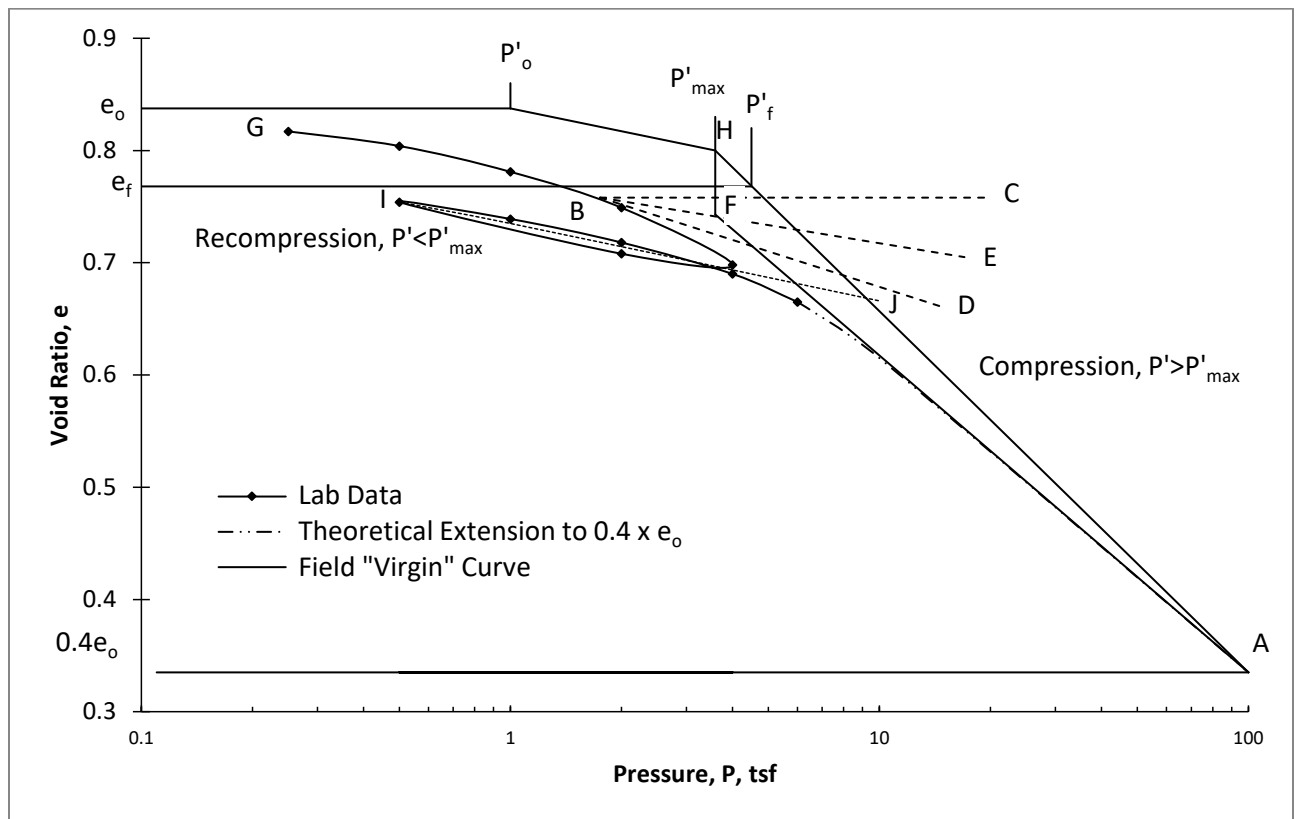

Figure D.9.1-1 Construction of the "Virgin" e-log P Curve

- (i) For overconsolidated specimens, $P'_{max} > P'_o$, the line connecting e_o , P'_o , and points (H) and (A) is called the field "virgin" curve, which should be used as the basis for all settlement calculations.
- (j) For normally consolidated specimens, $P'_{max} = P'_o$, draw a horizontal line from e_o , to the vertical line corresponding to P'_{max} , then continue that line down to point (A). The line connecting e_o , P'_{max} , and point (A) is the field "virgin" curve.
- (k) (OPTIONAL) For overconsolidated specimens, $P'_{max} > P'_o$, determine the recompression index, c_r . If a partial unload-reload sequence has been performed, the recompression index is the average slope of recompression. By using points I and J in [Figure D.9.1-1](#):

$$c_r = \frac{e_I - e_J}{\log \frac{P_J}{P_I}} \quad (\text{Eq. D.9.1-1a})$$

Geotechnical Manual

Appendix D Settlement Analysis Procedure

By selecting points I and J along the average slope of recompression line over one log cycle, [Equation D.9.1-1a](#) simplifies to:

$$c_r = e_I - e_J \quad (\text{Eq. D.9.1-1b})$$

- (l) (OPTIONAL) Determine the compression index, c_c , which is the slope of the line between points A and H in [Figure D.9.1-1](#). By using points A and H in [Figure D.9.1-1](#):

$$c_c = \frac{e_A - e_H}{\log \frac{P_H}{P_A}} \quad (\text{Eq. D.9.1-2a})$$

By selecting points (K and L) along the line between points A and H over one log cycle, [Equation D.9.1-2a](#) simplifies to:

$$c_c = e_K - e_L \quad (\text{Eq. D.9.1-2b})$$

- (m) (OPTIONAL) For overconsolidated specimens, $P'_{\max} > P'_o$, determine the overconsolidation ratio (OCR):

$$\text{OCR} = \frac{P'_{\max}}{P'_o} \quad (\text{Eq. D.9.1-3})$$

Geotechnical Manual

Appendix D Settlement Analysis Procedure

D.9.2 Magnitude of Settlement Calculation

D.9.2.1 Individual Layer Calculation

D.9.2.1.1 Method A

Once the “virgin” e-log P curve has been constructed, the magnitude of settlement for the layer in question can be computed. Find the void ratio, e_f , that corresponds to P'_f , on the virgin curve [$\Delta e = e_o - e_f$].

Calculate the settlement (S), as:

$$S = H_L \frac{\Delta e}{1 + e_o} \quad (\text{Eq. D.9.2-1})$$

Where:

H_L = The thickness of the compressible layer.

$\Delta e = e_o - e_f$

[Equation D.9.2-1](#) can be applied to normally consolidated, overconsolidated and underconsolidated soils.

D.9.2.1.2 Method B

An alternative calculation of the settlement (S) is to use c_c and c_r in the following equations:

For normally consolidated specimens, $P'_o = P'_{max}$:

$$S = \frac{c_c H_L}{(1 + e_o)} \log \left(\frac{P'_o + \Delta P'}{P'_o} \right) \quad (\text{Eq. D.9.2-2})$$

Geotechnical Manual

Appendix D Settlement Analysis Procedure

Where:

S = estimated primary settlement

H_L = thickness of compressible soil layer

e_o = initial void ratio

P'_o = effective overburden pressure at the center of the compressible soil layer

$\Delta P'$ = increase in stress at the center of the compressible soil layer resulting from embankment or foundation loads

c_c = compression index (dimensionless)

Note: [Equation D.9.2-2](#) is the same as [Equation 6.9.1.1-2](#).

For overconsolidated layers, $P'_{max} > P'_o$ and $P'_f > P'_{max}$:

$$S = \frac{c_r H_L}{(1+e_o)} \log \left(\frac{P'_o + (P'_{max} - P'_o)}{P'_o} \right) + \frac{c_c H_L}{(1+e_o)} \log \left(\frac{P'_{max} + (P'_o + \Delta P' - P'_{max})}{P'_{max}} \right) \quad (\text{Eq. D.9.2-3a})$$

Where:

P'_{max} = maximum past overburden effective pressure

c_r = recompression index (dimensionless)

[Equation D.9.2-3a](#) can be simplified to:

$$S = \frac{c_r H_L}{(1+e_o)} \log \left(\frac{P'_{max}}{P'_o} \right) + \frac{c_c H_L}{(1+e_o)} \log \left(\frac{P'_o + \Delta P'}{P'_{max}} \right) \quad (\text{Eq. D.9.2-3b})$$

For overconsolidated layers where $P'_{max} > P'_f$, [Equation D.9.2-3a](#) becomes:

$$S = \frac{c_r H_L}{(1+e_o)} \log \left(\frac{P'_o + \Delta P'}{P'_o} \right) \quad (\text{Eq. D.9.2-4})$$

Occasionally, a cohesive soil layer may exhibit a P'_{max} less than P'_o . This is called underconsolidation. It indicates a condition where the soil has not reached a state of equilibrium under the applied overburden pressure and commonly occurs if there is a lowering of the groundwater table. For underconsolidated layers:

Geotechnical Manual

Appendix D Settlement Analysis Procedure

$$S = \frac{c_c H_L}{(1+e_o)} \log \left(\frac{P'_o + \Delta P'}{P'_{\max}} \right) \quad (\text{Eq. D.9.2-5})$$

D.9.2.2 Multi-Layer Calculation

For a group of compressible layers, S is the sum of all individual layers' settlements, [S = S₁ + S₂ + S₃ + ...].

D.9.3 Settlement Time Estimation

The time rate of consolidation is variable. After a load is applied, the rate of consolidation is relatively rapid and gradually slows with time. To account for this variable rate, calculations are performed to estimate the time to achieve a certain average degree or percentage of consolidation.

D.9.3.1 Individual Layer Calculation

From the plot of the c_v versus log P data discussed in [Appendix D.9.1.3](#), a straight line was drawn between c_v values for the load increments that are immediately less than and immediately greater than (P'_f). On this c_v versus log P line, find the value of c_v that corresponds to P'_f . This value of c_v (denoted c_{vf}) is used in the calculation of settlement times, t_{50} and t_{90} , for the layer as follows (assuming double drainage conditions):

$$t_{\%} = \frac{(0.5H_L)^2}{c_{vf}} T_v \quad (\text{Eq. D.9.3-1})$$

Where:

$t_{\%}$ = The time required for a certain consolidation to occur, in minutes

H_L = Thickness of compressible layer, in inches

c_{vf} = The coefficient of consolidation at P'_f , in.² / minute

T_v = Time factor = 0.197 for 50% Consolidation

= 0.848 for 90% Consolidation

Geotechnical Manual

Appendix D Settlement Analysis Procedure

For single drainage condition, where an impermeable layer is above or below the compressible layer, use H_L instead of $0.5H_L$ in the equation.

D.9.3.2 Multi-Layer Calculation

Calculation of the estimated time to achieve a certain percentage of consolidation for a group of layers depends on the overall drainage path length of the group of consolidating layers. Two methods may be used either separately or in combination, as applicable, to calculate the estimated time to achieve a certain percentage of consolidation for multi-layer consolidation.

D.9.3.2.1 Method A

The first method calculates a weighted average of time for individual layers. If the consolidating layers are separated by a “free” draining layer like a sand layer, then the drainage path is either H_L or $0.5H_L$ of each individual consolidating layer (depending on single or double drainage condition), and the estimated time to achieve a certain percentage of consolidation may be calculated as a weighted average. The t_{50} and t_{90} for the group of layers are: the weighted averages of the t_{50} and t_{90} of the individual layers, proportional to their settlements. For example, the t_{50} for a group of three independently draining layers is:

$$t_{50(1,3\&5)} = \frac{t_{50(1)} S_1 + t_{50(3)} S_3 + t_{50(5)} S_5}{S_1 + S_3 + S_5} \quad (\text{Eq. D.9.3-2})$$

Note that the results of this weighted average method may vary slightly from calculations which are commonly used for determining the contribution of vertical drainage in conjunction with horizontal drainage in wick drain calculations for multi-layers. These calculations are not gone into detail in this discussion, but they may be used as an alternative.

D.9.3.2.2 Method B

The second method applies to multi-layer consolidation group, where two or more consolidating layers are adjacent to one another. For this configuration, the overall length of the drainage path must travel through multiple consolidating layers with different overall properties before reaching a “free” draining layer. Begin calculation of the overall estimated time to achieve a certain

Geotechnical Manual

Appendix D Settlement Analysis Procedure

percentage of consolidation by selecting the c_v value of one of the layers, and then determine an equivalent layer thickness for each of the other layers for that c_v ([NAVFAC, 1986](#)). Each of the equivalent layer thicknesses is then added to the thickness of the selected c_v layer to determine an overall equivalent thickness H_L' . The H_L' or $0.5 H_L'$ (depending on single or double drainage condition) is used with the selected c_v in [Equation D.9.3-1](#) to estimate t_{50} and t_{90} .

For an example of the second method with a composite of 3 consolidating layers:

Select c_{v1} from Layer 1. Then $H_1' = H_1$,

$$H_2' = H_2 \sqrt{\frac{c_{v1}}{c_{v2}}},$$

$$H_3' = H_3 \sqrt{\frac{c_{v1}}{c_{v3}}},$$

$H_L' = H_1' + H_2' + H_3'$, and

$$t_{\%} = \frac{(H_L')^2}{C_{v1}} T_v \quad (\text{assume single drainage for this example}).$$

D.10 Secondary Consolidation

If the magnitude of secondary consolidation is required, lab procedures may need to be modified to obtain sample height readings, at times, beyond the standard 400 minutes per increment. The secondary consolidation can be calculated using the log-fitting curve, for the load increment closest to P'_f . The procedure is as follows:

- (a) Select a time, t_1 , within the straight line portion of the curve beyond H_{100} (see [Figure D.5-1](#)).
- (b) Select another time, t_2 , corresponding to another log cycle, such that $t_2 = 10t_1$ within the same straight line portion. Find the values of H_1 and H_2 that correspond to t_1 and t_2 , respectively, on the line.

Geotechnical Manual

Appendix D Settlement Analysis Procedure

- (c) Determine the secondary settlement (S_{α}) for the load increment using:

$$S_{\alpha} = H_L \frac{(H_1 - H_2)}{H_i} \log \left(\frac{t}{t_{90}} \right) \quad (\text{Eq. D.10-1})$$

Where:

H_i = Sample height at the beginning of the load increment

t = Time span of interest from the beginning of primary settlement, i.e. 10, 20, 30... years.

t_{90} = The t_{90} for the layer being analyzed, in years.

Note: The t_{100} for the layer should, theoretically, be used instead of the t_{90} used above. However, determining the t_{100} for the layer is not possible, because T_v approaches infinity between 90 and 100% consolidation. Therefore, the use of t_{90} is considered a close approximation.

D.11 Report

The following items should be included in the settlement report for a group of compressible layers, obtained from one Shelby tube boring:

- (a) Location information.
- (b) Fill height.
- (c) Sample number, settlement, t_{50} , t_{90} , and the assumed drainage condition for each layer.
- (d) Total primary settlement (S_{100}) for the group of layers.
- (e) t_{50} and t_{90} for the group of layers.
- (f) If required, the secondary settlement (S_{α}) for a specified time period.
- (g) Other optional information as applicable or required.

Geotechnical Manual

Appendix D Settlement Analysis Procedure

D.12 References

AASHTO, Standard Specifications for Highway Materials and Methods of Sampling and Testing, 34rd Edition, Pt. IIA, “Standard Method of Test for One-Dimensional Consolidation Properties of Soils”, American Association of State Highway Officials, Washington, D.C., 2014, pp. T 216-1 – T 216-20.

AASHTO, AASHTO LRFD Bridge Design Specifications, Customary U.S. Units, 9th Edition, American Association of State Highway Officials, Washington, D.C., 2020, pp. 10-62 – 10-66.

Bowles, J.E. Foundation Analysis and Design. McGraw-Hill, Inc., New York, 1988.

NAVFAC, Soil Mechanics, Design Manual 7.01, Naval Facilities Engineering Command, Alexandria Virginia, 1986, pp. 7.1-231 – 7.1-236.

Osterberg, J.O. Influence Values for Vertical Stresses in a Semi-Infinite Mass Due to an Embankment Loading. Proc. IV Int’l. Conf. on Soil Mech. and Found. Engng., London, August 12-24, 1957, pp. 393-394.

Peck, R.B., Hanson, W.E., Thornburn, T.H. Foundation Engineering. John Wiley & Sons, Inc., New York, 1973.

Terzaghi, K., Peck, R.B., and Mesri, G. Soil Mechanics in Engineering Practice. John Wiley & Sons, Inc., New York, 1996.

Appendix E Glossary of Soil Terms

ASTM D 653 – 14 presents a comprehensive list of definitions which were prepared jointly by the American Society of Civil Engineers and the American Society for Testing and Materials. Therefore, this Glossary is only intended to define soils terms which are not included in ASTM D 653 – 14.

Accretion - A slow addition of the land which is created by deposition of water-borne deposits.

Argillaceous - Soils which are predominantly clay, or abounding in clay or clay-like materials.

Beach Ridge - Ridge of sand, or coarser grained material representing an old shoreline.

Blowout - A hollow eroded in and adjacent to a sand dune, by the wind.

Bluff - A bold, steep headland or promontory. A high, steep bank or low cliff. An almost vertically rising topographic feature, with a broad, flat, or rounded front.

Bog Soil - A soil with a muck or peat surface, underlain by peat.

Brown Forest Soil - A soil with dark brown surface horizon, relatively rich in humus, grading gradually into a gray calcareous parent material; developed under deciduous forest, in temperate humid regions.

Brunizem - A soil group having thick brownish-black (or very dark brown) A1 horizon, grading into a brownish B horizon, which may or may not be mottled. These soils were formed under tall grass vegetation, in cool - temperate regions, and were formerly called Prairie Soils.

Calcareous - Soil containing sufficient calcium carbonate, usually from limestone, to effervesce when treated with hydrochloric acid.

Catena - A group of soils, within one region, developed from similar parent material; but differing in characteristics of the solum, owing to differences of relief or drainage.

Cemented-Cementation - A condition occurring when the soil grains or aggregates are caused to adhere firmly, and are bound together by some material that acts as a cementing agent (as colloidal clay, iron, silica, aluminum hydrates, calcium carbonate, etc.). The degree of cementation, or the persistence of the cementation should be indicated.

Indurated - A soil cemented into a very hard mass that will not soften or lose its firmness when wet, and which requires much force to cause breakage. Rock-like.

Firmly Cemented - Cemented material, of appreciable strength, requiring considerable force to rupture the mass. Usually breaks with clean, but irregular fractures into hard fragments.

Weakly Cemented - Cemented material that is not strong, and the aggregates can be readily broken into fragments with a (more or less) clean fracture.

Chert - A very hard amorphous or cryptocrystalline rock, a form of silica or quartz (much the same as flint), which breaks into sharp angular fragments. Chert (or flint), in places, is a component (in important proportions) of the gravel, of outwash plains and moraines.

Classification (Soils) -

Pedological - A systematic arrangement based upon characteristics of soils *in situ*, including consideration of geological, physical, chemical, and genetic characteristics of the profile. In the pedological system, soils are classified according to the soil type; and the type is determined by the soil series and class. For example, "Miami loam" is the type name for a soil which is in the Miami series, and in which the topsoil is texturally a loam.

Engineering - An arrangement of soils into groups, based primarily upon characteristics which influence the engineering behavior of soil. The most widely used engineering soil classifications, in current use, are the AASHTO M 145 system and the ASTM D 2487 (USCS) system.

Claypan - Compact horizons or layers of soil which are high in clay content, and separated (more or less) abruptly from the overlying horizon. It is not cemented, and will flow together when wetted.

Colluvium - Heterogeneous deposits of rock fragments and soil material accumulated at the base of comparatively steep slopes through the influence of gravity, including: creep and local wash.

Compact - A soil that is dense and firm, but without any cementation.

Complex - A term used in detail soil mapping for those soil associations or parts of soil associations that are shown together as one, because of the limitations imposed by the scales used in soil mapping.

Crust - A brittle layer of hard soil formed on the surface of many soils, when dry.

Degradation - The breakdown of soil particles beyond the natural size of the individual grains, by mechanical action. Also, used in pedology to indicate major changes in soil profiles resulting from excessive leaching.

Delta - An alluvial deposit at the mouth of a stream which empties into a lake or ocean.

Dense - A soil mass in which a relatively small proportion of the total volume consists of pore spaces, with an absence of any large pores or cracks. See Porosity.

Desiccated - Deprived or exhausted of moisture.

Diamicton - Till deposit which has been reworked as it melted out at or near the margin.

Drainage, Soil - Refers to the rapidity and extent of the removal of water from the soil, especially by surface runoff and by flow through the soil. The following terms are used to describe soil drainage: good, fair, poor, and very poor. Their meanings are given in Chapter 2, Section 2.1.4.1.

Drift (Glacial) - Consists of all the material picked up, mixed, disintegrated, transported, and deposited through the action of glacial ice; or of water resulting primarily from the melting of glaciers.

Drumlin - Drumlins are smooth, elongated hills composed of till. Drumlins formed when till was deposited in a depression on the protected side of a rock hill. As the glacier advanced, it eroded the rock hill but was forced to glide over the drumlin. After the ice retreated, the drumlin became the high point in the area.

Dune Sand - Areas of wind-drifted sand in dunes, hummocks, and ridges; usually free from vegetation, and undergoing active erosion and redeposition by winds. The term “dune” may continue to be applied after the sand has been stabilized by a cover of vegetation.

Eluviation-Eluvial - The movement of soil material from one place to another within the soil, by solution or suspension. Horizons that have lost material through eluviation are referred to as eluvial, and those that have received material as illuvial. Eluviation may take place downward or sidewise, according to the direction of water movement. As used, the term refers especially, but not exclusively, to the movement of colloids; whereas, leaching refers to the complete removal of material in solution.

Eolian - Soils formed from materials transported and deposited by wind. The group includes not only the areas of windblown sands usually associated with sand dunes, but also large areas of the silty material known as loess.

Erosion (Land) - The wearing away of land surface by running water, wind, or other geological agents; including such process as gravitational creep.

Sheet - Removal of a (more or less) uniform layer of material from the land surface. Frequently, in sheet erosion, the eroding surface consists of numerous, very small rills.

Rill - That type of accelerated erosion by water, that produces small channels that can be obliterated by tillage.

Gully - That type of accelerated erosion, which produces channels larger than rills. Ordinarily, these erosion-produced channels carry water only during and immediately after rains, or following the melting of snow. Gullies are deeper than rills, and are not obliterated by normal tillage.

Erratic - A stone or boulder that has been carried from its place of origin by a glacier, and left stranded on, or surrounded by, completely different types of material.

Esker - A stratified deposit composed of a layer of gravel beneath a mound of sand or silt. The snake-shaped deposit was formed when streams eroded a tunnel out of a stagnant ice. This tunnel was then filled or partially filled with material deposited by the streams. As the glacier melted, it deposited the material in the tunnel as a steep-walled ridge of sand or gravel.

Field Moisture - The water that soil contains under field conditions.

Flocculate - To aggregate individual particles in small clusters; usually refers to colloidal particles.

Forest Soil - A general name for a soil developed primarily under coniferous, deciduous, or mixed forest; includes such pedologic soil groups as Brown Forest, and Gray-Brown Podzolic.

Fragipan - Highly compact soil horizons, high in content of sands, but relatively low in clay. When dry, the horizons are hard, but the induration disappears upon moistening. Sufficiently impermeable to retard downward movement of water, and impenetrable enough to cause flattening of tree roots.

Friable - A soil that can be readily ruptured and crushed with the application of moderate force. Easily pulverized, or reduced to crumb or granular structure.

Glacio-Fluvial - Glacial drift deposited by streams from melting glaciers. Such deposits occur in old glacial drainage channels or as outwash plains, deltas (representing deposition by streams flowing into glacial lakes). Eskers and kames are also examples of glacio-fluvial deposition. See Outwash, Delta, Esker and Kame.

Gley - A sticky, bluish-gray clay layer formed under the influence of high soil moisture.

Granular - Coarse-grained materials, having no cohesion, which derive their resistance to displacement from internal stability.

Gravitational Water (Free Water) (Groundwater) (Phreatic Water) - Water that is free to move through a soil mass, under the influence of gravity.

Gray-Brown Podzolic Soil - A group of soils having a comparatively thin organic covering and organic-mineral layers, over a grayish-brown leached layer (A2 horizon), resting upon a brown, blocky, illuvial B horizon; developed under deciduous forest in a temperate, moist climate.

Gritty - Containing a sufficient amount of angular grains of coarse sand or fine gravel to dominate the “feel”. Usually, applied to medium textured soils (loams) where the actual quantity of these coarse grains is quite small.

Hard - A soil which is very resistant to forces causing rupture or deformation. The soil mass is dense, and cannot be indented by the thumb or finger. The water content is near the shrinkage limit.

Humic Gley Soil - A group of soils with thick, black (to brownish black) “A” horizons, mottled gray (or olive-colored) “B” horizons (gley); developed under a vegetation of grass, sedges, and rushes with restricted drainage in humid (to sub-humid) temperate climate.

Igneous Rock - Rocks formed by crystallization of a molten magma, as those formed deep within the earth and crystalline throughout (intrusive rocks); and those that have poured out over the earth's surface, or have been blown as fragments into the air (extrusive rocks). Rocks of intermediate character occur as dikes (i.e., a long mass of igneous rock that cuts across the structure of adjacent rock), intrusive sheets, or stocks (i.e., a body of intrusive igneous rock of which less than 100 km² (40 mi²) is exposed).

Illuviation - Illuvial - A process of accumulation, by deposition of percolating waters of material transported in solution or suspension. Horizons in which material has been deposited, by illuviation.

Indurated - Rendered hard by heat, pressure or cementation. Relative degree of hardness (e.g., poorly indurated, moderately indurated, or well indurated). See Cemented-Cementation.

Infiltration - The downward entry of water, or other material into the soil.

Kame - A low steep-sided hill of stratified material, consisting of stream deposits left in a hole or crevasse, in a block of stagnant ice. When the ice melted, the kame became the highest point in the area.

Kettle - A depression left in a glacial drift, formed by the melting of an isolated block of glacial ice. See Pot Hole.

Lacustrine Soil - Soil forms from materials deposited in the water of lakes and ponds.

Laminated - An arrangement of the soil in very thin plates or layers, lying horizontally or parallel to the soil surface.

Lens - A body of sediment (commonly sand or clay) that is thick in the middle and thinning towards the edges.

Limestone - A general name for sedimentary rocks, composed essentially of calcium carbonate.

Lithosol - A group of soils with little (or no) profile development, consisting usually of a thin "A" horizon over a "C" horizon, composed of an imperfectly weathered mass of rock.

Loose - A soil with particles that are independent of each other, or are weakly cohering; with a maximum of pore space, and a minimum resistance to forces tending to cause rupture.

Massive - A soil mass showing no evidence of any distinct arrangement of soil particles. Structureless. May be found in soils of any texture. May also be applied to rock masses showing little (or no) evidence of stratification, foliation, or structure.

Mature Soil - A soil with well-developed characteristics, produced by the natural process of soil formation, and in equilibrium with its environment.

Metamorphic Rock - A rock, the constitution of which has undergone pronounced alteration, due to recrystallization. Such changes are, generally, affected by the combined action of pressure, heat, and water. Frequently, the result is a more compact, and more highly crystalline condition of the rock. Gneiss, schist, slate, and marble are common examples.

Mineral Soil - A soil composed chiefly of inorganic matter, in contrast to a soil composed largely of organic matter; such as, peat or muck.

Moraine - An accumulation of drift deposited by glaciers. The term End Moraine or Terminal, commonly, refers to hills and ridges, either extensive bold upland masses or low subdued elevations, marking places where the receding ice front remained stationary, for variable periods of time. The drift is unstratified (or only crudely stratified) and often consists of a heterogeneous mixture of sands, gravel, boulders, silt, and clay ("till"). Seams, beds, or lenses of water-sorted materials may be locally present in end moraines.

Mottled (Variegated) - Irregularly marked with spots of different colors.

Organic Matter - The more (or less) decomposed material of the soil derived from organic sources, usually from plant remains. The term "organic matter" covers such material in all stages of decay.

Outwash - Stratified accumulation of water deposited drift. The material is laid down by the meltwater streams issuing from the face of the glacial ice. Usually, laid out in a nearly level plain called an "outwash plain". If the glacier happens to be melting in valley, the outwash deposit is called a "valley train". Sometimes used to mean any water deposited material carried and laid down by streams.

Peat - Organic matter consisting of undecomposed (or slightly decomposed) plant material accumulated under condition of excessive moisture. If the organic remains are sufficiently fresh to identify plant forms, it is considered peat; if decomposition has gone so far as to make recognition of the plant forms impossible, it is muck.

Fibrous - Partially decomposed remains of mosses, sedges, reeds, and rushes; high in moisture holding capacity.

Sedimentary - Sedimentary peat usually collects in deep water, and is usually found deep in a profile. It is derived, from the remains of water lilies, pond weed, pollen, plankton, etc. The sedimentary peat is highly colloidal, and quite compact and rubbery. It is olive-green in its natural state, but turns black upon exposure to the air.

Woody - The partially decomposed remains of deciduous and coniferous trees, and their undergrowth. Woody peat is usually loose and non-fibrous in character.

Pedology - The scientific study of the origins, characteristics and uses of soils.

Phase - A subdivision of the soil type covering departures from the typical soil characteristics, insufficient to justify the establishment of a new soil type; yet, worthy of recognition. Phase variation may include color, texture, structure, topography, drainage, or any other feature of deviation from the typical.

Planosol - A group of soils with highly leached, usually gray, "A2" horizons resting abruptly on dense, "B" horizons which are very plastic and sticky when wet, hard when dry, and slowly permeable. This group of soils developed on nearly flat upland surface, under grass or forest vegetation, in a humid (to sub-humid) climate.

Plastic - A clay soil readily deformed without rupture. Pliable but cohesive, it can be molded rather easily, and rolled to threads 3 mm (1/8") in diameter without crumbling. The water content is in the lower range, between the plastic and the liquid limits.

Porous - A soil mass in which a large proportion of the mass consists of voids or pore spaces. See Porosity.

Pot Hole - A small basin depression common in outwash plains and moraines, often containing a lake or peat bog. Also, called "kettle" or "kettlehole". Also, as a geological term, a very small basin worn in the rock of a stream bed, by eddies whirling a stone or gravel.

Prairie Soil - A general name for a soil developed under tall grass in temperate, relatively humid climate; as formerly used, equivalent to the Brunizem soil group, but in the general sense might include other grassland soils. See Brunizem.

Red-Yellow Podzolic Soil - A group of soils having a thin organic covering and organic mineral layers over a yellow-brown, leached layer "A2", which rests on a red, illuvial "B"; developed under a deciduous (or mixed deciduous) and coniferous forest in a warm, temperate, moist climate.

Regosol - A group of soils that consist mainly of soft (or unconsolidated) mineral materials, which have no clearly developed soil profiles. They include such materials as beach sand, dune sand, etc.

Relief - The elevations or inequalities of a land surface considered collectively.

Rock Flour - A fine-grained soil, usually sedimentary, of low plasticity and cohesion. Particles are usually in the lower range of silt sizes. At high moisture contents, it may become "quick" under the action of traffic.

Saturated - All soil voids filled with water; zero air voids.

Sedimentary Rock - Rock composed of lithified sediments. May be formed mechanically, chemically, or organically.

- Rocks such as conglomerate, sandstone, and shale formed of fragments of other rocks; transported from their source, and deposited in water.
- Rocks formed by precipitation from solution; such as, rock salt, gypsum, and limestone.
- Rocks forms from secretion of organisms; such as, limestone.

Sharp - Containing angular particles, in sufficient amount, to dominate the "feel". Abrasive.

Siliceous - Soils which are predominantly composed of, or abounding in silica (or silicate particles) chiefly sand-sized, or matrix.

Sinkhole - Closed depression in earth's surface formed by subsidence of soil into holes, in underlying soluble rock. The underlying rock is, generally, limestone; and the holes have resulted from erosion, due to solution by groundwater.

Slickenside - When large shear displacements occur within a narrow zone, in an overconsolidated clay layer or slope, the clay particles become oriented along the direction of shear, and a polished surface or slickenside forms. In some cases, the large shear displacements occur as a progressive failure over a period of time.

Soil Map - A representation designed to portray the distribution of soil types, phases, and complexes, as well as other selected cultural and physical features of the earth's surface.

Soil Separate - The individual size groups of soil particles; such as, sand, silt, and clay.

Soil Series - A group of soils having the same character of profile (the same general range in color, structure, texture, and sequence of horizons), the same general conditions of relief and drainage, and usually, a common or similar origin and mode of formation. A group of soil types closely similar in all respects, except the texture of surface soils. While the soil type is the unit of soil mapping, the series is the most important in soil classification (as it expresses in full the profile differences).

Soil Type - A soil which has relatively uniform profile characteristics throughout the full extent of its occurrence. The unit of soil mapping. The name of the soil type is a combination of a series name, and the textural classification of the surface soil. For example, Fox Sandy Loam. See Classification.

Solifluction - Saturated soil flowing down the surface of a slope; a mud flow characteristic of soils in high latitudes. See creep.

Solonetz Soil - A group of soils having a surface horizon of friable soil underlain by a dark, hard (when dry) type of soil. Solonetz soils usually have a columnar structure, and are highly alkaline; developed under grass or shrub vegetation; most commonly, in a sub-humid to semi- arid climate, but sometimes in a humid region.

Solum - The upper part of the soil profile, above the parent material in which the processes of soil formation are taking place. In mature soils, this includes the A and B horizons. The character of the material may be, and usually is, greatly unlike that of the parent material beneath.

Stratified - Composed of, or arranged in strata or layers; such as, stratified alluvium. The term is applied to geological materials. Those layers in soils that are produced by the processes of soil formation are called horizons, while those inherited from the parent material are called strata.

Substratum - The C horizons. In most cases, the substratum is the deeper, unweathered parent material. In some soils, it may be material quite distinct in character from that which weathered to form the overlying soil mass. In recent soils where distinct A or B horizons may not exist, it usually is applied to strata distinctly different in color, texture, or structure from the upper layers.

Transitional Soil - Soil that does not clearly belong to any important soil group or series with which it is associated, but has some properties of each.

Transported Soils - Soils moved and transported (by various agencies) from their point of origin, and deposited in a new location.

Colluvial - Soils moved by the action of water.

Water-formed - Soils moved by the action of water.

- Marine or sea-laid soils formed at the mouths of rivers, along sea coasts, salt marshes, bar, etc.
- Lacustrine or lake-laid soils occur as beds of extinct lakes, beaches and terraces, remains of old water levels and shores.
- Alluvial or stream-laid soils deposited along streams, the first bottom or present flood plain, the second bottom or terrace lands exposures due to change of river bed, deltas, etc.

- **Glacial** - Soil formed from parent material that has been deposited by glacial activity.
- **Loessial** - Soils deposited by the action of wind. Fine grained soils, loess, dune sands, etc.

Varves - A paired arrangement of layers (in water-deposited materials) reflecting seasonal changes during deposition. The fine sand and silt, or rock flour, are deposited in the glacial lake during the summer season; and the finer clayey particles are usually deposited in a thinner layer during the winter.

This page left intentionally blank.

Appendix F Bibliography

F.1 Introduction

This bibliography consists of three parts: General, FHWA Publications, and District Specific geologic and pedologic references. The General and FHWA reference bibliographies contain a list of references to those publications which were used in the preparation of the manual text and the other appendices. The District Specific bibliography contains other publications in the fields of soils and geology, which should be useful to the engineer who wishes to become more familiar with the origin and nature of the earth materials of Illinois. Since a complete inventory of pedologic soil maps and reports is given in the County Soil Survey Reports, published by USDA/NRCS, reference to these publications has not been made. Moreover, since District Specific reference lists rapidly become out-of-date, it is suggested that geotechnical engineers maintain regular contact with the University of Illinois' Agricultural Experiment Station, and the Illinois State Geological Survey. The release of new publications by these two public agencies may be useful in the field of geotechnical engineering.

F.2 General References

- Alexander, J. D. (1968), "Color Chart for Estimating Organic Matter in Mineral Soils in Illinois", Univ. of IL Agr. Exp. Sta., Publ. AG-1941, 3 p.
- American Association of State Highway Officials (2002), Standard Specifications for Highway Bridges, 17th Edition.
- American Association of State Highway Officials (2014), Standard Specifications for Highway Materials and Methods of Sampling and Testing, 34rd Edition, Pts. I & II.
- American Association of State Highway Officials (2020), AASHTO LRFD Bridge Design Specifications, Customary U.S. Units, 9th Edition.
- American Association of State Highway Officials (2013), AASHTO Standard Specifications for Structural Supports for Highway Signs, Luminaires, and Traffic Signals, 6th Edition, Includes Errata and 2015 Interim Revisions, 320 p.

- American Society for Testing and Materials (2014), Annual Book of ASTM Standards Soil and Rock, Volume 4.08 and 4.09.
- Berg, R. C., J. P. Kempton, and K. Cartwright (1984), "Potential for Contamination of Shallow Aquifers in Illinois", Illinois State Geological Survey Cir. 532, 30 p.
- Berg, R. C., and H. A. Wehrmann (1989), "Geological and Hydrological Factors for Siting Hazardous or Low-level Radioactive Waste Disposal Facilities", Illinois State Geological Survey Cir. 546, 61 p.
- Bergstrom, R. E. (ed.) (1968), "The Quaternary of Illinois, A Symposium", Univ. of IL College of Agriculture, Spec. Publ. 14, 179 p.
- Bier, J. A. (1956), Landforms of Illinois (map), Illinois State Geological Survey.
- Bowles, J. E. (1988), Foundation Analysis and Design, McGraw-Hill, New York, 1,004 p.
- Broms, G., and L. Forssblad (1968), "Classification of Soils with Reference to Compaction", Swedish Geot. Inst., Preliminary Rept. 29, Stockholm, 7 p.
- Chicago, C. o. (2015). *CDOT, Office of Underground Coordination*. Retrieved August 7, 2015, from City of Chicago:
http://www.cityofchicago.org/city/en/depts/cdot/provdrs/construction_information/svcs/office_of_undergroundcoordination.html
- Clegg, K. E. (1972), "Subsurface Geology and Coal Resources of the Pennsylvanian System in DeWitt, McLean, and Piatt Counties, Illinois", Illinois State Geological Survey Cir. 473, 25 p.
- Clegg, K. E., and J. C. Bradbury (1956), "Igneous Intrusive Rocks of Illinois and their Economic Significance", Illinois State Geological Survey Rept. of Inv. 1971, 19 p., 6 pls.
- Dunkley, C. L. (1973), Suggestions for Temporary Erosion and Siltation Control Measures, U.S. Dept. of Transportation, 40 p.
- Fehrenbacher, J. B., G. O. Walker, and H. L. Wascher (1967), "Soils of Illinois", Univ. of IL Agr.

Exp. Sta. Bull. 725, 47 p.

Flint, R. F. (1971), Glacial and Quaternary Geology, John Wiley, New York, 892 p.

Frazee, C. J., J. B. Fehrenbacher, and W. C. Krumbein (1970), "Loess Distribution from a Source", Soil Science Soc. of Am. Proc. Vol. 24, No. 2, p. 296-301.

Frye, J. C., L. R. Follmer, H. D. Glass, J. M. Masters, and H. B. Willman (1974), "Earliest Wisconsinan Sediments and Soils", Illinois State Geological Survey Circ. 485, 12 p.

Frye, J. C., H. D. Glass, J. P. Kempton, and H. B. Willman (1969), "Glacial Till of Northwestern Illinois", Illinois State Geological Survey Circ. 437, 47 p.

Frye, J. C., H. D. Glass, and H. B. Willman (1962), "Stratigraphy and Mineralogy of the Wisconsinan Loesses of Illinois", Illinois State Geological Survey Circ. 334, 55 p., 1 pl.

Frye, J. C., and H. B. Willman (1960), "Classification of the Wisconsinan Stage in the Lake Michigan Glacial Lobe", Illinois State Geological Survey Circ. 285, 16 p.

Frye, J. C., H. B. Willman, and R. F. Black (1965), "Outline of Glacial Geology of Illinois and Wisconsin", Illinois State Geological Survey Reprint 1965-N, 28 p.

Frye, J. C., H. B. Willman, and H. D. Glass (1960), "Gumbotil, Accretion-Gley, and the Weathering Profile", Illinois State Geological Survey Circ. 295, 39 p.

Fuller, M. L. (1912; re-issued 1992), "The New Madrid Earthquake", U. S. Geol. Surv. Bull. 494, 119 p.

Heigold, P. C., and T. H. Larson (1990), "Seismicity of Illinois", Illinois State Geological Survey EGN 133, 20 p.

Highway Research Board (1973), "Erosion Control on Highway Construction", N.C.H.R.P. Synthesis of Highway Practice 18, 52 p.

- Holtz, R.D., and W.D. Kovacs (1981), An Introduction to Geotechnical Engineering, Prentice-Hall, Inc., New Jersey, 733 p.
- Horberg, L. (1950), "Bedrock Topography of Illinois", Illinois State Geological Survey Bull. 73, 111 p., 2 pls.
- Horbert, L. (1953), "Pleistocene Deposits Below the Wisconsin Drift in Northeastern Illinois", Illinois State Geological Survey Rept. of Inv. 165, 61 p., 2 pls.
- Hough, J. L. (1958), Geology of the Great Lakes, Univ. of IL Press, 313 p.
- IDOT (1995), Aggregate Technician Course Workbook, Springfield, IL.
- IDOT (2012), Bridge Manual, Springfield, IL.
- IDOT (2010), Bureau of Design and Environment Manual, Springfield, IL.
- IDOT (2006), Construction Manual, Springfield, IL.
- IDOT (2017), Culvert Manual, Springfield, IL.
- IDOT (2020), Description and Minimum Requirements for Prequalification. Retrieved from <http://idot.illinois.gov/Assets/uploads/files/Doing-Business/Manuals-Guides-&-Handbooks/Highways/Design-and-Environment/Description%20And%20Minimum%20Requirements%20For%20Prequalification.pdf>
- IDOT (2011), Drainage Manual, Springfield, IL.
- IDOT (1999), Geotechnical Manual, Springfield, IL.
- IDOT (2019), Manual of Test Procedures for Materials, Springfield, IL. Retrieved from (<http://www.idot.illinois.gov/doing-business/material-approvals/soils/index>, located under the "References" tab, and then under the "Manuals" drop down button.)

IDOT (2020), [Project Procedures Guide](#), Springfield, IL.

IDOT (2014), [Road, Bridge and Other Related Laws of Illinois, 2014 Edition](#), Thomson Reuters, p. 384.

IDOT (2012), [Sign Structures Manual](#), Springfield, IL.

IDOT (2016), [Specific Task Training Program Drilled Shaft Foundation Construction Inspection S-32 Class Reference Guide](#), Springfield, IL.

IDOT (2012), [Supplement to the Work Site Protection Manual](#), Springfield, IL.

IDOT (2012), [Standard Specifications for Road and Bridge Construction](#), Springfield, IL, 1128 p.

IDOT (2016), [Standard Specifications for Road and Bridge Construction](#), Springfield, IL, 1160 p.

IDOT (2005), [Subgrade Stability Manual](#), Springfield, IL, 27 p.

IDOT (2016), [Supplemental Specifications and Recurring Special Provisions](#), Springfield, IL.

IDOT (2016), [Traffic Control Field Manual](#), Springfield, IL.

Johnson, A. I. (1963), "Field Method for Measurement of Infiltration", [U.S. Geol. Surv. Water Supply Paper 1544-F](#).

Killey, M. M., J. K. Hines, and P. B. DuMontelle (1985), "Landslide Inventory of Illinois", [Illinois State Geological Survey Cir. 534](#), 28 p.

Koerner, R. M. (1990), "[Designing with Geosynthetics](#)", Prentice-Hall Inc., Englewood Cliffs, N.J., 652 p.

Kolata, D. R., T. C. Buschbach, and J. D. Trewogy (1978), "The Sandwich Fault Zone of Northern Illinois", [Illinois State Geological Survey Cir. 505](#), 26 p.

Leighton, M. M., G. E. Ekblaw, and L. Horbert (1948), "Physiographic Division of Illinois", [Illinois](#)

State Geological Survey Rept. of Inv. 129, 33 p.

Leighton, M. M., and H. B. Willman (1950), "Loess Formations of the Mississippi Valley", Illinois State Geological Survey Rept. of Inv. 149, 27 p., 2 pls.

Leverett, F. (1899), The Illinois Glacial Lobe, U.S. Geol. Surv. Mon, 38,817 p.

Liu, T. K., and T. H. Thornburn (1965), "Engineering Index Properties of Some Surficial Soils in Illinois", Univ. of IL Eng. Exp. Sta. Bull. 477, 111 p.

Livneh, M., and I. Ishai, (1987), "Pavement and Material Evaluation by a Dynamic Cone Penetrometer", Sixth International Conference on the Structural Design of Asphalt Pavements, Ann Arbor, Michigan.

Long, J. H., J. Hendrix, and A. Baratta (2009), "Evaluation/Modification of IDOT Foundation Piling Design and Construction Policy", Univ. of Illinois, Illinois Center for Transportation Research Report No. FHWA-ICT-09-037, 213 p.

Long, Jim and Andrew Anderson (2012), "Improved Design for Driven Piles on a Pile Load Test Program in Illinois", Univ. of Illinois, Illinois Center for Transportation Research Report No. FHWA-ICT-12-011, 677 p.

Long, Jim and Andrew Anderson (2014), "Improvement of Driven Pile Installation and Design in Illinois: Phase 2", Univ. of Illinois, Illinois Center for Transportation Research Report No. FHWA-ICT-14-019, 97 p.

Lutenegger, A. J., D. J. DeGroot, C. Mizra, and M. Bozozuk (1995), "Recommended Guidelines for Sealing Geotechnical Exploratory Holes", NCHRP Report 378, National Academy Press.

Mauer, M.C., M. de Beer (1988), "Computer Programs to Plot DCP Data - Users Manual", Division of Roads and Transport Technology, Pretoria, South Africa.

McGinnis, L. D., P. C. Heigold, C. P. Ervin, and M. Heidari (1976), "The Gravity Field and Tectonics of Illinois", Illinois State Geological Survey Cir. 494, 28 p.

- McGinnis, L. D., and J. P. Kempton (1961), "Integrated Seismic Resistivity and Geologic Studies of Glacial Deposits", Illinois State Geological Survey Circ. 323, 23 p.
- McLerran, J. H. (1957), "Glossary of Pedologic (soils) and Landform Terminology for Soil Engineers", Hwy. Res. Bd. Special Rept. 25, 32 p.
- Naval Facilities Engineering Command (1986), Soil Mechanics, Design Manual 7.01, Alexandria, Virginia, p. 7.1-231 to 7.1-236, and 7.1-246 to 7.1-253.
- Osterberg, J. O. (1957), "Influence Values for Vertical Stresses in a Semi-Infinite Mass Due to an Embankment Loading", Proc. 4th Intl. Conf. on Soil Mechanics and Foundation Engineering, London, Vol I, p. 393-394.
- Paikowsky, S. G., M. C. Canniff, K. Lesny, A. Kisse, S. Amatya, and R. Muganga (2010), "LRFD Design and Construction of Shallow Foundations for Highway Bridge Structures", [NCHRP Report 651](#), National Academy of Sciences.
- Peck, R. B, W. E. Hanson, and T. H. Thornburn (1974), Foundation Engineering, 2nd Ed., John Wiley, New York, 524 p.
- Peck, R. B., and H. O. Ireland (1957), "Backfill Guide", J. Struct. Div. ASCE ST4, p. 1321-1 to 1321-10.
- Piskin, K., and R. E. Bergstrom (1967), "Glacial Drift in Illinois; Thickness and Character", Illinois State Geological Survey Circ. 416, 33 p.
- Porter, O. J. (1938), "Preparation of Subgrades", Proc. Hwy. Res. Bd. Vol. 18, p. 324-331.
- Robnett, Q. L., and M. R. Thompson (1970), "Recommendations for Stabilization of Illinois Soils", Univ. of IL Eng. Exp. Sta. Bull. 502, 225 p.
- Rooriquez, A. R., H. del Castillo, and G. F. Sowers, (1988), Soil Mechanics in Highway Engineering, Trans Tech Publications, Germany, 843 p.

- Runge, E.C.A., L. E. Tyler, and S. G. Carmer (1969), "Soil Type Acreages of Illinois", Univ. of Illinois Agr. Exp. Sta. Bull. 735, 76 p.
- Simon, J. A. (1961), Shipping Coal Lines in Illinois (Map), Illinois State Geological Survey. Smith, G. D. (1941), "Illinois Loess", Univ. of IL Agr. Exp. Sta. Bull 490, 184 p.
- Stokes, W. L., and D. J. Varnes (1955), "Glossary of Selected Geologic Terms", Proc. Colo. Sci. Soc., Vol, 16, 165 p.
- Stein, J. S., and B. J. Dempsey (2004), "Performance Evaluation of Longitudinal Pipe Underdrains", Univ. of Illinois, Illinois Center for Transportation Research Project No. IHR-R25, 38 p.
- Straub, T. D., T. M. Over, and M. M. Domanski (2013), "Ultimate Pier and Contraction Scour Prediction in Cohesive Soils at Selected Bridges in Illinois", Univ. of Illinois, Illinois Center for Transportation Research Report No. FHWA-ICT-13-025, 49 p.
- Taylor, D. W. (1937), Stability of Earth Slopes, Journal of the Boston Society of Civil Engineers 24, p. 197-246
- Taylor, D. W. (1948), Fundamentals of Soil Mechanics, John Wiley and Sons, New York, p. 406-479.
- Terzaghi, K., R. B. Peck, and G. Mesri (1996), Soil Mechanics in Engineering Practice, 3rd Ed., John Wiley, New York, 549 p.
- Thornburn, T. H. (1963), "Surface Deposits of Illinois", Univ. of Ill. Eng. Sta. Circ. 80, 135 p.
- Transportation Research Board (1987) "Lime Stabilization, Reactions, Properties, Design, and Construction", State of the Art Report 5, Washington, D.C., 59 p.
- Treworgy, C. G., and M. H. Bargh (1982), "Deep-Minable Coal Resources of Illinois", Illinois State Geological Survey Cir. 527, 65 p.

- Treworgy, C. G., L. E. Bengal, and A. G. Dingwell (1978), "Reserves and Resources of Surface-Minable Coal in Illinois", Illinois State Geological Survey Cir. 504, 44 p.
- Treworgy, J. D. (1981), "Structural Features in Illinois - a Compendium", Illinois State Geological Survey Cir. 519, 22 p.
- Turner, A. K., and R. L. Schuster (1996), Landslides: Investigation and Mitigation TRB Special Report 247, Washington D.C., 673 p.
- United States Army Corps of Engineers (1984), Engineering and Design Pavement Criteria for Seasonal Frost Conditions Mobilization Construction, [USACE EM 1110-3-138](#).
- University of Illinois Agriculture Experiment Station (1957), Drainage Guide for Illinois, 45 p.
- Wascher, H. L., J. B. Fahrenbacher, R. T. Odell, and P. T. Veale (1950), "Illinois Soil Type Description", Univ. of IL Agr. Exp. Sta. Publ. AG-1443, 293 p.
- Wascher, H. L., J. D. Alexander, B. W. Ray, A. H. Beavers, and R. T. Odell (1960), "Characteristics of Soils Associated With Glacial Till in Northeastern Illinois", Univ. of IL Agr. Exp. Sta. Bull. 655, 155 p., 1 pl.
- Willman, H. B. (1973), "Geology Along the Illinois Waterway - A Basis for Environmental Planning", Illinois State Geological Survey Circ. 478, 48 p., 7 pls.
- Willman, H. B. (1973), "Rock Stratigraphy of the Silurian System in Northeastern and Northwestern Illinois", Illinois State Geological Survey Cir. 479, 55 p.
- Willman, H. B., et al (1967), Geologic Map of Illinois, Illinois State Geological Survey.
- Willman, H. B., et. al. (1975), "Handbook of Illinois Stratigraphy", Illinois State Geological Survey Bull. 95, 261 p.
- Willman, H. B., and J. C. Frye (1970), "Pleistocene Stratigraphy of Illinois", Illinois State Geological Survey Bull. 94, 204 p., 3 pls.

Willman, H. B., H. D. Glass, and J. C. Frye (1963), "Mineralogy of Glacial Till and their Weathering Profiles in Illinois, Part I - Glacial Till", Illinois State Geological Survey Cir. 347, 55 p.

Willman, H. B., H. D. Glass, and J. C. Frye (1966), "Mineralogy of Glacial Till and their Weathering Profiles in Illinois. Part II - Weathering Profiles", Illinois State Geological Survey Cir. 400, 76 p.

Willman, H. B., J. A. Simon, B. M. Lynch, and V. A. Langenheim (1968), "Bibliography and Index of Illinois Geology through 1965", Illinois State Geological Survey Bull.92, 373 p.

Winterkorn, H. F., and H. Y. Fang (1975), Foundation Engineering Handbook, Van Nostrand Reinhold, New York, 751 p.

Witzak, M. W. (1972), "Relationships Between Physiographic Units and Highway Design Factors", Natl. Coop. Hwy. Res. Program Rept. 132, 161 p.

Webster's II New College Dictionary (1995), Houghton Mifflin Company, V.S., 1514 p.

F.3 FHWA Publications

The following list of FHWA documents are available through the National Technical Information Service (NTIS), Springfield, Virginia, 22161:

Abramson, L., G. Boyce, T. Lee, and S. Sharma (1994), Advanced Technology for Soil Slope Stability: Volume 1, Slope Stability Manual, FHWA-SA-94-005.

Arman, A., N. Samtani, R. Castelli and G. Munfakh (1997), Geotechnical and Foundation Engineering, Module 1 - Subsurface Investigations, [FHWA-HI-97-021](#).

Baker, W. H. (1983), Design and Control of Chemical Grouting: Volume 3 - Engineering Practice, FHWA-RD-82-038.

Baker, W. H. (1983), Design and Control of Chemical Grouting: Volume 4 - Executive Summary, FHWA-RD-82-039.

Barksdale, R. D., and R. C. Bachus (1983), Design and Construction of Stone Columns: Volume 1, [FHWA-RD-83-026](#).

Berg, R. R. (1992), Guidelines for Design, Specification, and Contracting of Geosynthetic Mechanically Stabilized Earth Slopes on Firm Foundations, FHWA-SA-93-025.

Berg, R. R., B. R. Christopher and N. C. Samtani (2009 a), "Design and Construction of Mechanically Stabilized Earth Walls and Reinforced Soil Slopes, Volume I," [FHWA-NHI-10-024](#).

Berg, R. R., B. R. Christopher and N. C. Samtani (2009 b), "Design and Construction of Mechanically Stabilized Earth Walls and Reinforced Soil Slopes, Volume II," [FHWA-NHI-10-025](#).

Brown, D. A., J. P. Turner and R. J. Castelli (2010), "Drilled Shafts: Construction Procedures and LRFD Design Methods," [FHWA-NHI-10-016](#).

- Bruce, M., R. Berg, J. Collin, G. Filz, M. Terashi, and D. Yang (2013), Federal Highway Administration Design Manual: Deep Mixing for Embankment and Foundation Support, [FHWA-HRT-13-046](#).
- Chamberlain, E. J. (1982), Frost Susceptibility of Soil: Review of Index Tests, FHWA-RD-82--081.
- Cheney, R. S. (1984), Permanent Ground Anchors, FHWA-DP-68-1.
- Cheney, R. S., and R. G. Chassie (1993), Soils and Foundations Workshop Manual, FHWA-HI-88-009.
- Christopher, B.R., S.A. Gill, J.P. Giroud, I. Juran, J.K. Mitchell, F. Schlosser and J. Dunncliff (1990 a), Reinforced Soil Structures, Volume I: Design and Construction Guidelines, FHWA-RD-89-043.
- Christopher, B.R., S.A. Gill, J.P. Giroud, I. Juran, J.K. Mitchell, F. Schlosser and J. Dunncliff (1990 b), Reinforced Soil Structures, Volume II: Summary of Research and System Information, FHWA-RD-89-044.
- Christopher, B.R., and R.D. Holtz (1989), Geotextile Design and Construction Guidelines, FHWA-HH-90-001.
- Collins, R. J., and J. J. Emery (1983), Kiln Dust - Fly Ash Systems for Highway Bases and Subbases, FHWA-RD-82-167.
- Elias, V., (1996), Corrosion/Degradation of Soil Reinforcement for Mechanically Stabilized Earth Walls and Reinforced Soil Slopes, [FHWA-SA-96-072](#).
- Elias, V., B.R. Christopher and R.R. Berg (2001), Mechanically Stabilized Earth Walls and Reinforced Soil Slopes Design and Construction Guidelines, FHWA-NHI-00-043.
- Elias, V., and B.R. Christopher (1996), Mechanically Stabilized Earth Walls and Reinforced Soil Slopes, Design and Construction Guidelines, FHWA-SA-96-071.

- Elias, V., and I. Juran (1991), Soil Nailing for Stabilization of Highway Slopes and Excavations, FHWA-RD-89-198.
- Elias, V., J. Welsh, J. Warren, and R. Lukas (1998), Ground Improvement Technical Summaries: Volume 1, [FHWA-SA-98-086](#).
- Elias, V., K.L. Fishman, B.R. Christopher and R.R. Berg (2009), Corrosion/Degradation of Soil Reinforcements for Mechanically Stabilized Earth Walls and Reinforced Soil Slopes, [FHWA-NHI-09-087](#)
- Holtz, R. D, B. R. Christopher, and R. R. Berg (2008), Geosynthetic Design & Construction Guidelines, FHWA-NHI-07-092
- Holtz, R. D., B. R. Christopher, and R. R. Berg (1998), Geosynthetic Design and Construction Guidelines, [FHWA-HI-95-038](#).
- Huck, P. J., H. J. Pincus, M. M. Singh, and Y. P. Chugh (1974), Determination of the In-Situ State of Stress in Soil Masses, FHWA-RD-74-68.
- Kimmerling, R. E., (2002), Geotechnical Circular No. 6 Shallow Foundations, [FHWA-IF-02-054](#)
- Krizek, R. J., and W. H. Baker (1983), Design and Control of Chemical Grouting: Volume 2 - Materials Description Concept, FHWA-RD-82-037.
- Moulton, L. K., and Principal Engineer (1980), Highway Subdrainage Design, FHWA-TS-80-224.
- Riaund, J. L., and J. Miran (1992), The Cone Penetrometer Test, FHWA SA-91-043.
- Rixner, J., S. Kraemer, and A. Smith (1986), Prefabricated Vertical Drains: Volume 1, Engineering Guidelines, [FHWA/RD-86/168](#).
- Rock Slopes: Design, Excavation, Stabilization (1989), FHWA-TS-89-045.
- Terrel, R. L., J. A. Epps, E. J. Barenberg, J. K. Mitchell, and M. R. Thompson (1979), Soil Stabilization in Pavement Structures: A User's Manual, Volumes 1 and 2, FHWA-IP-80-2.

Walkinshaw, J., and C. Dumas (1995), FHWA Geotechnical Metrication Guidelines, FHWA-SA-95-035

Waller, M. J., P. J. Huck, and W. H. Baker (1983), Design and Control of Chemical Grouting: Volume 1 - Construction Control, FHWA-RD-82-036.

Wang, S.-T., and L. C. Reese (1993), COM624P – Laterally Loaded Pile Analysis Program for the Microcomputer, Version 2.0, [FHWA-SA-91-048](#)

Weatherby, D. E. (1982), Tiebacks, [FHWA-RD-82-047](#).

F.4 District Specific References

District Specific geologic and pedologic references:

F.4.1 District 1

Alden, W. C. (1902), "Riverside, Chicago, DesPlaines, and Calumet Quadrangles, Illinois-Indiana", Geologic Atlas of the United States, Folio 81, U.S. Geol. Surv., 14 p.

Anderson, R. C., and D. A. Block (1962), "Sand and Gravel Resources of McHenry County, Illinois", Illinois State Geological Survey Circ. 336, 15 p., 1 pl.

Block, D. A. (1960), "Sand and Gravel Resources of Kane County, Illinois", Illinois State Geological Survey Circ. 299, 11 p., 1 pl.

Bretz, J. H. (1939), "Geology of the Chicago Region, Part I, General", 118 p. (1955), "Part II, The Pleistocene", 132 p., Illinois State Geological Survey Bull. 65

Dixon, W. G., Jr. (1985), "Sources of Information on Engineering Geology and Related Topics for Northeastern Illinois", Illinois State Geological Survey EGN 110.

Ekblaw, G. E., J. E. Lamar (1964), "Sand and Gravel Resources of Northeastern Illinois", Illinois State Geological Survey Circ. 359, 8 p., 1 pl.

Fisher, D. J. (1935), "Geology and Mineral Resources of the Joliet Quadrangle", Illinois State Geological Survey Bull 51, 160 p., 6 pls.

Hackett, J. E., and M. R. McComas (1969), "Geology for Planning in McHenry County", Illinois State Geological Survey Circ. 438, 31 p., 1 pl.

Horberg, J. L. (1953), "Pleistocene Deposits Below the Wisconsin Drift in Northeastern Illinois", Illinois State Geological Survey Rept. of Inv. 165, 61 p.

Hough, J. L. (1958), Geology of the Great Lakes, Univ. of IL Press, 313 p.

- Larsen, J. I. (1973), "Geology for Planning in Lake County", Illinois State Geological Survey Circ. 481, 43 p., 4 pls.
- Mason, A. C. (1943), "Thickness of Glacial Drift in DuPage County", Illinois State Geological Survey Circ. 92, p. 5-6.
- Masters, J. M. (1978), "Sand and Gravel and Peat Resources in Northeastern Illinois", Illinois State Geological Survey Cir. 503, 11 p.
- Peck, R. B., and W. C. Reed (1954), "Engineering Properties of Chicago Subsoils", Univ. of IL Eng. Exp. Sta. Bull. 423, 62 p.
- Powers, W. E., and G. E. Ekblaw (1940), "Glaciation of the Grayslake, Illinois, Quadrangle", Illinois State Geological Survey Circ. 63, 7 p.
- Thornburn, T. H., D. J. Hagerty, and T. K. Liu (1970), "Engineering Soil Report, Will County, Illinois", Univ. of IL Engr. Exp. Sta. Bull. 501, 195 p.
- Trowbridge, A. C. (1912), "Geology and Geography of the Wheaton Quadrangle", Illinois State Geological Survey Bull. 19, 77 p., 12 pls.
- Wickham, S. S., W. H. Johnson, and H. D. Glass (1988), "Regional Geology of the Tiskilwa Till Member, Wedron Formation, Northeastern Illinois", Illinois State Geological Survey Cir. 543, 35 p.
- Willman, H. B. (1971), "Summary of the Geology of the Chicago Area", Illinois State Geological Survey Circ. 460, 77 p., 1 pl.
- Willman, H. B. (1973), "Rock Stratigraphy of the Silurian System in Northeastern and Northwestern Illinois", Illinois State Geological Survey Cir. 479, 55 p.

F.4.2 District 2

- Anderson, R. C. (1964), "Sand and Gravel Resources of DeKalb County", Illinois State Geological Survey Circ. 367, 16 p., 1 pl.
- Anderson, R. C. (1967), "Sand and Gravel Resources Along the Rock River in Illinois", Illinois State Geological Survey Circ. 414, 17 p., 1 pl.
- Anderson, R. C. (1980), "Geology for Planning in Rock Island County, Illinois", Illinois State Geological Survey Cir. 510, 35 p.
- Berg, R. C., J. P. Kempton, and A. N. Stecyk (1984), "Geology for Planning in Boone and Winnebago Counties", Illinois State Geological Survey Cir. 531, 69 p.
- Bradbury, J. C. (1965), "Dolomite Resources of Boone and DeKalb Counties", Illinois State Geological Survey Cir. 379, 22 p.
- Bretz, J. H. (1923), "Geology and Mineral Resources of the Kings Quadrangle", Illinois State Geological Survey Bull. 43C, 100 p., 3 pls.
- Brueckmann, J. E., and R. E. Bergstrom (1968), "Ground-Water Geology of the Rock Island, Monmouth, Galesburg, and Kewanee Area, Illinois", Illinois State Geological Survey Rept. of Inv. 221, 56 p.
- Doyle, F. L. (1965), "Geology of the Freeport Quadrangle", Illinois State Geological Survey Circ.395, 24 p., 1 pl.
- Flint, R. F. (1931), "Glaciation in Northwestern Illinois", Am.Jour.Sci., Vol.21, No. 25 p. 422-440.
- Foster, J. W. (1956), "Groundwater Geology of Lee and Whiteside Counties, Illinois", Illinois State Geological Survey Rept. of Inv. 194, 67 p.
- Frye, J. C., H. D. Glass, J. P. Kempton, and H. B. Willman, (1969), "Glacial Till of Northwestern Illinois", Illinois State Geological Survey Cir. 437, 47 p.

- Grant, U. S., and E. F. Burchard (1907), "Lancaster-Mineral Point Quadrangles, Wisconsin-Iowa-Illinois", Geologic Atlas of the U.S., Folio 145, U.S. Geol.Surv., 14 p.
- Hackett, J. E. (1960), "Ground-Water Geology of Winnebago County, Illinois", Illinois State Geological Survey Rept. of Inv. 213, 63 p., 2 pls.
- Hunter R. E., and J. P. Kempton (1967), "Sand and Gravel Resources of Boone County Illinois", Illinois State Geological Survey Circ. 417, 14 p., 1 pl.
- Kempton, J. P. (1963), "Subsurface Stratigraphy of the Pleistocene Deposits of Central Northern Illinois", Illinois State Geological Survey Circ. 356, 43 p.
- Knappen, R. S. (1926), "Geology and Mineral Resources of the Dixon Quadrangle", Illinois State Geological Survey Bull. 49, 141 p., 5 pls.
- Kolata, D. R., and T. C. Buschbach (1976), "Plum River Fault Zone of Northwestern Illinois", Illinois State Geological Survey Cir. 491, 20 p.
- Larsen, J. L. (1973), "Geology for Planning in Lake County, Illinois", Illinois State Geological Survey Cir. 481, 43 p.
- MacClintock, P., and H. B. Willman (1959), "Geology of Buda Quadrangle, Illinois", Illinois State Geological Survey Circ. 275, 29 p., 1 pl.
- McGinnis, L. D., and P. C. Heigold (1974), "A Seismic Refraction Survey of the Meredosia Channel Area of Northwestern Illinois", Illinois State Geological Survey Cir. 488, 19 p.
- Nelson, W. J. (1981), "Faults and their Effect on Coal Mining in Illinois", Illinois State Geological Survey Cir. 523, 38 p.
- Savage, T. E., and J. A. Udden (1921), "Geology and Mineral Resources of the Milan and Edginton Quadrangles", Illinois State Geological Survey Bull. 38C, 98 p., 1 pl.

Shaffer, P. R. (1954), "Extension of Tazewell Glacial Substage of Western Illinois and Eastern Iowa", Illinois State Geological Survey Rept. of Inv. 174, 13 p.

Shaffer, P. R. (1956), "Farmdale Drift in Northwestern Illinois", Illinois State Geological Survey Rept. of Inv. 198, 25 p., 2 pls.

Shaw, E. W., and A. C. Trowbridge (1916), "Galena-Elizabeth Quadrangles, Illinois-Iowa", Geologic Atlas of the U.S., Folio 200, U.S. Geol. Surv., 12 p.

Trowbridge, A. C., E. Q. Shaw, and B. H. Schockel (1916), "Geology and Geography of the Galean and Elizabeth Quadrangles", Illinois State Geological Survey Bull. 26, 233 p., 25 pls.

Willman, H. B., H. D. Glass, and J. C. Frye (1989), "Glaciation and Origin of The Geest in the Driftless Area of Northwestern Illinois", Illinois State Geological Survey Cir. 535, 44 p.

F.4.3 District 3

Athy, L. F. (1928), "Geology and Mineral Resources of the Herscher Quadrangle", Illinois State Geological Survey Bull. 55, 120 p., 2 pls.

Barrows, H. H. (1910), "Geography of the Middle Illinois Valley", Illinois State Geological Survey Bull. 15, 128 p., 16 pls.

Cady, G. H. (1919), "Geology and Mineral Resources of the Hennepin and LaSalle Quadrangles", Illinois State Geological Survey Bull. 37, 136 p., 6 pls.

Culver, H. E. (1922), "Geology and Mineral Resources of the Morris Quadrangle", Illinois State Geological Survey Bull. 43B, 114 p., 3 pls.

DuMontelle, P. B., N. C. Hester, and R. E. Cole (1971), "Landslides Along the Illinois River Valley South and West of LaSalle and Peru, Illinois", Illinois State Geological Survey Env. Geol. Note 48, 16 p.

Ekblaw, G. E., and J. E. Lamar (1964), "Sand and Gravel Resources of Northeastern Illinois", Illinois State Geological Survey Circ. 359, 8 p., 1 pl.

Gross, D. L., and R. C. Berg (1981), "Geology of the Kankakee River System in Kankakee County, Illinois", Illinois State Geological Survey EGN 92, 80 p.

Jacobson, R. J. (1985), "Coal Resources of Grundy, LaSalle, and Livingston Counties, Illinois", Illinois State Geological Survey Cir. 536, 58 p.

LaMar, J. E. (1929), "The Limestone Resources of the Pontiac-Fairbury Region", Illinois State Geological Survey Rept. of Inv. 17, 27 p.

Leighton, M. M. (1926), "A Notable Type Pleistocene Section - The Farm Creek Exposure near Peoria, Illinois", Illinois State Geological Survey Rept. of Inv. 11, 15 p.

McComas, M. R. (1968), "Geology Related to Land Use in the Hennepin Region", Illinois State Geological Survey Circ. 422, 24 p.

Ostrom, M. E. (1957), "Subsurface Dolomite and Limestone Resources of Grundy and Kendall Counties", Illinois State Geological Survey Circ. 230, 25 p.

Sauer, C. O. (1916), "Geography of the Upper Illinois Valley and History of Development", Illinois State Geological Survey Bull. 27, 208 p., 2 pls.

Smith, W. H. (1968), "Strippable Coal Reserves of Illinois, Part 6 - LaSalle, Livingston, Grundy, Kankakee, Will, Putnam, and parts of Bureau of Marshall Counties", Illinois State Geological Survey Circ. 419, 29 p., 2 pls.

Thornburn, T. H., R. K. Morse, and T. K. Liu (1966), "Engineering Soil Report: Livingston County, Illinois", Univ. of IL Engr. Exp. Sta. Bull. 482, 128 p.

Willman, H. B., and J. N. Payne (1942), "Geology and Mineral Resources of the Marseilles, Ottawa, and Streator Quadrangles", Illinois State Geological Survey Bull. 66, 388 p., 30 pls.

F.4.4 District 4

Anderson, R. C., and R. E. Hunter (1965), "Sand and Gravel Resources of Peoria County", Illinois State Geological Survey Circ. 381, 16 p., 1 pl.

Barows, H. H. (1910), "Geography of the Middle Illinois Valley", Illinois State Geological Survey Bull. 15, 128 p., 16 pls.

Harvey, R. D. (1964), "Mississippian Limestone Resources in Fulton, McDonough, and Schuyler Counties, Illinois", Illinois State Geological Survey Circ. 370, 27 p.

Hinds, H. H. (1919), "Colchester-Macomb Quadrangles, Illinois", Geologic Atlas of the U.S., Folio 208, U.S. Geol. Surv. 14 p.

Horberg, L. (1956), "Pleistocene Deposits Along the Mississippi Valley in Central-Western Illinois", Illinois State Geological Survey Rept. of Inv. 192, 39 p., 1 pl.

Horberg, L., T. E. Larson, and Max Suter (1950), "Groundwater in the Peoria Region", Illinois State Geological Survey Bull. 75, 128 p.

Hunter, R. E. (1966), "Sand and Gravel Resources of Tazewell County, Illinois", Illinois State Geological Survey Circ. 399, 22 p., 1 pl.

Leighton, M. M. (1926), "A Notable Type Pleistocene Section - The Farm Creek Exposure Near Peoria, Illinois", Illinois State Geological Survey Rept. of Inv. 11, 15 p

Savage, T. C. (1921), "The Geology and Mineral Resources of the Avon and Canton Quadrangles", Illinois State Geological Survey Bull. 38B, 68 p., 1 pl.

Savage, T. E., and M. L. Nebel (1921), "Geology and Mineral Resources of the LaHarpe and Good Hope Quadrangles", Illinois State Geological Survey Bull. 43A,. 89 p., 1 pl.

Savage, T. E., and J. A. Udden (1921), "Geology and Mineral Resources of the Milan and Edginton Quadrangles", Illinois State Geological Survey Bull. 38C, 68 p., 1 pl.

Searight, T. K., and W. H. Smith (1960), "Strippable Coal Reserves of Illinois, Part 5B - Mercer, Rock Island, Warren, and parts of Henderson and Henry Counties", Illinois State Geological Survey Circ. 439, 24 p., 2 pls.

Smith, W. H., and D. J. Berggren (1963), "Strippable Coal Reserves of Illinois, part 5A - Fulton, Henry, Knox, Peoria, Stark, Tazewell, and parts of Bureau, Marshall, Mercer, and Warren Counties", Illinois State Geological Survey Circ. 348, 59 p., 4 pls.

Wanless, H. R. (1929), "Geology and Mineral Resources of the Alexis Quadrangle", Illinois State Geological Survey Bull. 57, 230 p., 6 pls.

Wanless, H. R. (1957), "Geology and Mineral Resources of the Beardstown, Glasford, Havana, and Vemont Quadrangles", Illinois State Geological Survey Bull. 82, 233 p.

F.4.5 District 5

Hester, N. C., and R. C. Anderson (1969), "Sand and Gravel Resources of Macon County, Illinois", Illinois State Geological Survey Cir. 446, 16 p.

Hunt, C. S., and J. P. Kempton (1977), "Geology for Planning in DeWitt County, Illinois", Illinois State Geological Survey EGN 83, 42 p.

Jacobson, R. J., and L. E. Bengal (1981), "Strippable Coal Resources of Illinois - Part 7- Vermilion and Edgar Counties", Illinois State Geological Survey Cir. 521, 24 p.

Wickham, J. T. (1979), "Glacial Geology of North-Central and Western Champaign County, Illinois", Illinois State Geological Survey Cir. 506, 30 p.

F.4.6 District 6

- Ball, J. R. (1958), "The Physiography and Surficial Geology of the Carlinville Quadrangle, Illinois", Illinois State Geological Survey Circ. 32, 5 p.
- Ball, J. R. (1952), "Geology and Mineral Resources of the Carlinville Quadrangle", Illinois State Geological Survey Bull. 77, 147 p., 7 pls.
- Barrows, H. H. (1910), "Geography of the Middle Illinois Valley", Illinois State Geological Survey Bull. 15, 128 p., 16 pls.
- Baxter, J. W. (1970), "Limestone and Dolomite Resources of Jersey County, Illinois", Illinois State Geological Survey Circ. 488, 28 p., 1 pl.
- Baxter, J. W. (1972), "Limestone Resources of Scott County, Illinois", Illinois State Geological Survey Circ. 472, 24 p., 1 pl.
- Bergstrom, R. E., K. Piskin, and L. R. Follmer (1976), "Geology for Planning in the Springfield-Decatur Region, Illinois", Illinois State Geological Survey Cir. 497, 76 p.
- Clegg, K. E. (1961), "Subsurface Geology and Coal Resources of the Pennsylvania System-Sangamon, Macon, Menard, and Parts of Christian and Logan Counties, Illinois", Illinois State Geological Survey Circ. 312, 28 p., 4 pls.
- Frye, I. C., H. B. Willman, and H. D. Glass (1964), "Cretaceous Deposits and The Illinoian Glacial Boundary in Western Illinois", Illinois State Geological Survey Circ. 364, 28 p.
- Goodwin, J. H., and R. D. Harvey (1980), "Limestone Resources of Adams and Brown Counties, Illinois", Illinois State Geological Survey Cir. 512, 20 p.
- Heigold, P. C., and R. W. Ringler (1979), "A Seismic Refraction Survey of the Lower Illinois Valley Bottomlands", Illinois State Geological Survey Cir. 507, 18 p.

- Hester, N. C. (1970), "Sand and Gravel Resources of Sangamon County, Illinois", Illinois State Geological Survey Circ. 452, 20 p., 1 pl.
- Horberg, L. (1956), "Pleistocene Deposits Along the Mississippi Valley in Central-Western Illinois", Illinois State Geological Survey Rept. of Inv. 192, 39 p., 1 pl.
- Johnson, W. H. (1964), "Stratigraphy and Petrography of Illinoian and Kansan Drift in Central Illinois", Illinois State Geological Survey Circ. 378, 38 p.
- Labotka, T. C., and N. C. Hester (1971), "Sand and Gravel Resources of Mason County, Illinois", Illinois State Geological Survey Circ. 464, 20 p., 1 pl.
- Lee, W. (1926), "Gillespie-Mt. Olive Quadrangles, Illinois", Geologic Atlas of the U.S., Folio 220, U.S. Geol. Surv., 14 p.
- MacClintock, P. (1929), "Physiographic Divisions of the Area Covered by the Illinoian Drift-Sheet in Southern Illinois", Illinois State Geological Survey Rept. of Inv. 19, 57 p.
- Reinhertsen, D. L. (1964), "Strippable Coal Reserves of Illinois, Part 4 - Adams, Brown, Calhoun, Hancock, McDonough, Pike, Schuyler, and the Southern Parts of Henderson and Warren Counties", Illinois State Geological Survey Circ. 374, 32 p., 1 pl.
- Shaw, E. W., and T. E. Savage (1913), "Tallula-Springfield Quadrangles, Illinois", Geologic Atlas of the U.S., Folio 188, U.S. Geo. Surv., 12 p.
- Smith, W. H. (1961), "Strippable Coal Reserves of Illinois, Part 3 - Madison, Macoupin, Jersey, Greene, Scott, Morgan, and Cass Counties", Illinois State Geological Survey Circ. 311, 40 p., 4 pls.
- Wanless, H. R. (1957), "Geology and Mineral Resources of the Beardstown, Glasford, Havana, and Vermont Quadrangles", Illinois State Geological Survey Bull. 82, 233 p., 7 pls.
- Whiting, L., (1956), "Geology and History of Oil Production in the Decatur-Mt. Auburn- Springfield Area, Illinois", Illinois State Geological Survey Circ. 211, 17 p.

F.4.7 District 7

Bristol, H. M., and J. D. Treworgy (1979), "The Wabash Valley Fault System in Southeastern Illinois", Illinois State Geological Survey Cir. 509, 24 p.

Brownfield, R. L. (1954), "Structural History of the Centralia Area", Illinois State Geological Survey Rept. of Inv. 172, 31 p.

Frye, J. C., et al (1972), "Geology and Paleontology of Late Pleistocene Lake Saline, Southeastern Illinois", Illinois State Geological Survey Circ. 471, 44 p.

Fuller, M. L., and F. G. Clapp (1904), "Patoka, Indiana-Illinois Quadrangle", Geologic Atlas of the U.S., Folio 105, U.S. Geol. Surv., 12 p.

Jacobs, A. M., and J. A. Lineback (1969), "Glacial Geology of the Vandalia, Illinois Region", Illinois State Geological Survey Circ. 442, 23 p.

MacClintock, P. (1929), "Physiographic Divisions of the Area Covered by the Illinoian Drift- Sheet in Southern Illinois", Illinois State Geological Survey Rept. of Inv. 19, 57 p.

Nance, R. B., and C. G. Treworgy (1981), "Strippable Coal Resources of Illinois - Part 8-Central and Southeastern Counties", Illinois State Geological Survey Cir. 515, 32 p.

Newton, W. A. (1941), "Surface Structure Map of Shelby, Effingham, and Fayette Counties", J. M. Wellar, and A. H. Bell, "Explanation and Stratigraphic Summary", Illinois State Geological Survey Rept. of Inv. 76, 2 p., 1 pl.

Shaw, E. W. (1915), "Newly Discovered Beds of Extinct Lakes in Southern and Western Illinois and Adjacent States", Illinois State Geological Survey Bull. 20, p. 139-157.

Shaw, E. W. (1923), "Carlyle-Centralia Quadrangles, Illinois", Geologic Atlas of the U.S., Folio 216, U.S. Geol. Surv. 10 p.

Weller, J. M., and A. H. Bell (1936), "The Geology and Oil and Gas Possibilities of Parts of Marion and Clay Counties, with a Discussion of the Central Portion of the Illinois Basin", Illinois State Geological Survey Rept. of Inv. 40, 54 p.

Pryor, W. A. (1956), "Groundwater Geology of White County, Illinois", Illinois State Geological Survey Rept. of Inv. 196, 50 p., 4 pls.

F.4.8 District 8

Baxter, J. W. (1965), "Limestone Resources of Madison County, Illinois", Illinois State Geological Survey Circ. 390, 39 p., 1 pl.

Baxter, J. W. (1970), "Limestone and Dolomite Resources of Jersey County, Illinois", Illinois State Geological Survey Cir. 448, 26 p.

Bergstrom, E. E., and T. R. Walker (1956), "Groundwater Geology of the East St. Louis Area, Illinois", Illinois State Geological Survey Rept. of Inv. 191, 44 p., 4 pls.

Bradbury, J. C. (1963), "Limestone Resources of the Lower Kaskaskia Valley", Illinois State Geological Survey Circ. 346, 22 p., 1 pl.

Fenneman, N. M. (1909), "Physiography of the St. Louis Area", Illinois State Geological Survey Bull. 12, 83 p., 18 pls.

Jacobs, A. M. (1971), "Geology for Planning in St. Clair County, Illinois", Illinois State Geological Survey Circ. 465, 35 p., 8 pls.

MacClintock, P. (1929), "Physiographic Divisions of the Area Covered by the Illinoian Drift- Sheet in Southern Illinois", Illinois State Geological Survey Rept. of Inv. 19, 57 p.

Rubey, W. W. (1952), "Geology and Mineral Resources of the Hardin and Brussels Quadrangles, Illinois", U.S. Geol. Surv. Prof. Paper 218, 179 p.

Shaw, E. W. (1915), "Newly Discovered Beds of Extinct Lakes in Southern and Western Illinois and Adjacent States", Illinois State Geological Survey Bull. 20, p. 139-157.

Shaw, E. W. (1921), "New Athens-Okawville Quadrangles, Illinois", Geologic Atlas of the U.S., Folio 213, U.S. Geol. Surv., 12 p.

Shaw, E. W. (1923), "Carlyle-Centralia Quadrangles, Illinois", Geologic Atlas of the U.S., Folio 216, U.S. Geol. Surv., 10 p.

Smith, W. H. (1958), "Strippable Coal Reserves of Illinois, Part 2 - Jackson, Monroe, Perry, Randolph, and St. Clair Counties", Illinois State Geological Survey Circ. 260, 35 p., 4 pls.

Udden, J. A., and E. W. Shaw (1915), "Belleville-Breese Quadrangles, Illinois", Geologic Atlas of the U.S. Folio 195, U.S. Geol. Surv., 13 p.

Weller, Stuart, and J. M. Weller (1939), "Preliminary Geological Maps of the Pre-Pennsylvanian Formations in part of Southwestern Illinois - Waterloo, Kimmswick, New Athens, Crystal City, Renault, Baldwin, Chester, and Campbell Hill Quadrangles", Illinois State Geological Survey Rept. of Inv. 59, 15 p., 3 pls.

F.4.9 District 9

- Allgaier, G. J., and M. E. Hopkins (1975), "Reserves of the Herrin (No. 6) Coal in the Fairfield Basin in Southeastern Illinois", Illinois State Geological Survey Cir. 489, 31 p.
- Baxter, J. W., and G. A. Desborough (1965), "Areal Geology of the Illinois Flourspar District. Part 2 - Karbers Ridge and Rosiclare Quadrangles", Illinois State Geological Survey Circ. 385, 40 p., 2 pls.
- Baxter, J. W., G. A. Desborough, and C. W. Shaw (1967), "Areal Geology of the Illinois Flourspar District. Part 3 - Herod and Shetlerville Quadrangles", Illinois State Geological Survey Circ. 413, 41 p., 2 pls.
- Baxter, J. W., P. E. Potter, and F. L. Doyle (1963), "Areal Geology of the Illinois Flourspar District. Part 1 - Saline Mines, Cave in Rock, Dekoven, and Repton Quadrangles", Illinois State Geological Survey Circ. 342, 43 p., 2 pls.
- Berg, R. B., and J. M. Masters (1994), "Geology of Microcrystalline Silica (Tripoli) Deposits, Southernmost Illinois", Illinois State Geological Survey Cir. 555, 89 p.
- Biggs, D. L., and J. E. Lamar (1955), "Sandstone Resources of Extreme Southern Illinois - A Preliminary Report", Illinois State Geological Survey Rept. of Inv. 188, 21 p., 2 pls.
- Bradbury, J. C., and J. W. Baxter (1992), "Intrusive Breccias at Hicks Dome Hardin County, Illinois", Illinois State Geological Survey Cir. 550, 23 p.
- Butts, C (1925), "Geology and Mineral Resources of the Equality-Shawneetown Area", Illinois State Geological Survey Bull. 47, 76 p., 3 pls.
- Desborough, G. A. (1961), "Geology of the Pomona Quadrangle, Illinois", Illinois State Geological Survey Circ. 320, 16 p., 1 pl.
- Frye, J. C., et. al. (1972), "Geology and Paleontology of Late Pleistocene Lake Saline, Southeastern Illinois", Illinois State Geological Survey Cir. 471, 44 p.

- Heigold, P. C. (1976), "An Aeromagnetic Survey of Southwestern Illinois", Illinois State Geological Survey Cir. 495, 28 p.
- Jacobson, R. J. (1992), "Geology of the Goreville Quadrangle, Johnson and Williamson Counties, Illinois", Illinois State Geological Survey Bull. 97, 32 p.
- Jacobson, R. J. (1993), "Coal Resources of the Dekoven and Davis Members (Carbondale Formation) in Gallatin and Saline Counties, Southeastern Illinois", Illinois State Geological Survey Cir. 551, 41 p.
- Keys, J. N., and W. J. Nelson (1980), "The Rend Lake Fault System in Southern Illinois", Illinois State Geological Survey Cir. 513, 23 p.
- Kolata, D. R., J. D. Treworgy, and J. M. Masters (1981), "Structural Framework of the Mississippi Embayment of Southern Illinois", Illinois State Geological Survey Cir. 516, 38 p.
- Lamar, J. E. (1925), "Geology and Mineral Resources of the Carbondale Quadrangle", Illinois State Geological Survey Bull. 48, 172 p., 5 pls.
- Lamar, J. E. (1952), "Siliceous Materials of Extreme Southern Illinois - Silica, Novaculite, Ganister, Calico Rock, and Chert Gravels", Illinois State Geological Survey Rept. of Inv. 166, 39 p.
- LaMar, J. E. (1959), "Limestone Resources of Extreme Southern Illinois", Illinois State Geological Survey Rept. of Inv. 211, 81 p., 8 pls.
- MacClintock, P. (1929), "Physiographic Divisions of the Area Covered by the Illinoian Drift- Sheet in Southern Illinois", Illinois State Geological Survey Rept. of Inv. 19, 57 p.
- Nelson, W. J. (1993), "Geology of the Bloomfield Quadrangle, Johnson County, Illinois", Illinois State Geological Survey Bull. 99, 30 p.
- Nelson, W. J., and H. F. Krause (1981), "The Cottage Grove Fault System in Southern Illinois", Illinois State Geological Survey Cir. 522, 65 p.

- Nelson, W. J., and D. K. Lumm (1987), "Structural Geology of Southeastern Illinois and Vicinity", Illinois State Geological Survey Cir. 538, 70 p.
- Nelson W. J., et. al. (1991), "Geology of the Eddyville, Stonefort, and Creal Springs Quadrangles, Southern Illinois", Illinois State Geological Survey Bull. 96, 85 p.
- Pryor, W. A., and C. A. Ross (1962), "Geology of the Illinois Parts of the Cairo, LaCenter, and Thebes Quadrangles", Illinois State Geological Survey Circ. 332, 39 p., 2 pls.
- Ross, C. A. (1964), "Geology of the Paducah and Smithland Quadrangles in Illinois", Illinois State Geological Survey Circ. 360, 32 p., 1 pl.
- Shaw, E. W. (1910), "The Geology and Coal Resources of the Murphysboro Quadrangle", Illinois State Geological Survey Bull. 16, p. 286-294.
- Shaw, E. W. (1915), "Newly Discovered Beds of Extinct Lakes in Southern and Western Illinois and Adjacent States", Illinois State Geological Survey Bull 20, p. 139-157.
- Shaw, E. W., and T. E. Savage, (1912), "Murphysboro-Herrin Quadrangles, Illinois", Geologic Atlas of the U.S., Folio 185, U.S. Geol. Surv., 15 p.
- Smith, W. H. (1957), "Strippable Coal Reserves of Illinois, Part 1 - Gallatin, Hardin, Johnson, Pope, Saline, and Williamson Counties", Illinois State Geological Survey Circ. 228, 39 p., 4 pls.
- Smith, W. H. (1958), "Strippable Coal Resources of Illinois. Part 2 -Jackson, Monroe, Perry, Randolph, and St. Clair Counties", Illinois State Geological Survey Cir. 260, 35 p.
- Strode, R., and J. E. Lamar (1953), "Sands and Silts of Extreme Southern Illinois", Illinois State Geological Survey Circ. 184, 28 p.
- Weibel, C. P., et. al. (1993), Geology of the Waltersburg Quadrangle, Pope County, Illinois", Illinois State Geological Survey Bull. 98, 41 p.

Weller, J. M. (1940), "Geology and Oil Possibilities of Extreme Southern Illinois-Union, Johnson, Pope, Hardin, Alexander, Pulaski, and Massac Counties", Illinois State Geological Survey Rept. of Inv. 71, 71 p., 1 pl.

Weller, J. M., and G. E. Ekblaw (1940), "Preliminary Geologic Map of Parts of the Alto Pass, Jonesboro, and Thebes Quadrangles in Union, Alexander, and Jackson Counties", J. M. Weller, "Explanation and Stratigraphic Summary", Illinois State Geological Survey Rept. of Inv. 70, 26 p., 1 pl.

Weller, S. (1920), "Geology of Hardin County and the Adjoining Part of Pope County", Illinois State Geological Survey Bull. 41, 416 p., 10 pls.

Willman, H. B., and J. C. Frye (1980), "The Glacial Boundary in Southern Illinois", Illinois State Geological Survey Cir. 511, 23 p.