



State of Illinois
Illinois Department of Transportation

Survey Manual



Illinois Department of Transportation
Bureau of Design and Environment

SURVEY MANUAL

REVISED May 2015

TABLE OF CONTENTS

CHAPTER ONE.....	General
CHAPTER TWO.....	Geodetic Surveying
CHAPTER THREE.....	GPS
CHAPTER FOUR.....	Accuracy Standards
CHAPTER FIVE.....	Design Surveys
CHAPTER SIX.....	Photogrammetry
CHAPTER SEVEN.....	Cadastral Surveys (Land Surveys)
CHAPTER EIGHT.....	Terrestrial Laser Scanning
CHAPTER NINE.....	Hydrographic/Bathymetric Surveys
CHAPTER TEN.....	Construction Surveys
CHAPTER ELEVEN.....	Subsurface Utility Engineering (SUE)
CHAPTER TWELVE.....	Safety
APPENDICES	
A.	Curve Information
B.	Electronic Survey Data Exchange Formats
C.	Illinois State Plane Coordinates
D.	Confined Space Policy
E.	Survey Point Codes

COVER ART CREDIT:

Image: Illinois State Water Survey, A Pioneer in Solid Terrain Modeling.

Created by: Geographic Information Systems (GIS) specialist Kingsley Allan, Illinois State Water Survey, in collaboration with the Imaging Technology Group, Beckman Institute for Advanced Science and Technology, University of Illinois at Urbana-Champaign. Model scale is 1:720,000 (horizontal and vertical scale is exaggerated 30 times).

CHAPTER ONE
GENERAL

BUREAU OF DESIGN AND ENVIRONMENT
SURVEY MANUAL

May 2015

CHAPTER ONE

GENERAL

Table of Contents

	Page
I. INTRODUCTION.....	1-1
A. Purpose of Manual	1-1
B. Surveying Classifications.....	1-3
B.1 Route Surveying	1-3
B.2 Cadastral (Land) Surveying.....	1-3
II. SURVEY PERSONNEL.....	1-3
III. TYPES OF SURVEYS	1-4
A. Control Surveys.....	1-4
B. Location Surveys.....	1-4
C. Design Surveys.....	1-4
D. Cadastral (Land) Surveys	1-4
E. Construction Surveys	1-5
F. Photogrammetric Surveys	1-5
G. Hydraulic Surveys.....	1-5
IV. EQUIPMENT	1-5
V. FIELD NOTE RECORDING	1-5
A. General	1-5
B. Types of Recording Media.....	1-6
B.1 Book Size	1-6
B.2 Duplicating.....	1-7
B.3 Loose Leaf.....	1-7
B.4 Electronic Media.....	1-7
C. Indexing	1-7
VI. FIELD COMMUNICATIONS.....	1-8
A. Property Owner Contact	1-8
A.1 Verbal	1-8
A.2 Written	1-8
B. Right of Entry	1-9
B.1 Right to Enter.....	1-9
B.2 Denial of Entry	1-9
B.3 Damage Claims	1-9
VII. DEFINITIONS	1-9

CHAPTER ONE

GENERAL

I. INTRODUCTION

A. PURPOSE OF MANUAL

The Illinois Department of Transportation Surveying Manual has been written to present a unified plan for surveying functions and their relationships to other functions and divisions within the Department. The Manual contains material that is of both an informational and instructional nature. Guidelines and procedures are spelled out in detail in the hope that greater uniformity and quality can be attained in surveying activities in and for the Department.

The intent of this manual is to provide surveyors and engineers, working for the Department as employees or consultants, with an outline of the expected standards, and potential methods that will achieve those standards, which should be used to procure the data necessary to depict existing topography of a highway improvement and prepare construction plans. It is essential that all data collected be accurately recorded so design plans match the actual field conditions.

There are numerous excellent reference books on surveying methodologies, procedures, equipment, and technology. This Survey Manual is not meant to be a treatise on surveying. Rather, it is meant to outline and summarize methodologies, accuracies, procedures, and current technologies acceptable to the Department. The Department recognizes that acceptable procedures and technologies are but a snapshot in time. Surveying is a branch of physical sciences that has undergone tremendous leaps in technology and it is anticipated that this trend will continue for many years to come.

Prudent revisions to this Manual will be addressed as the need arises.

A Professional Land Surveyor's License in the State of Illinois is broad in its scope of areas of professional practice. The Department has, at present, only one area of "Prequalification" to cover all areas of practice in surveying. The Professional Surveyor in Illinois is also bound by a professional code of ethics, see Title 68: Professions and Occupations Chapter VII: Department of Financial and Professional Regulation Subchapter B: Professions and Occupations Part 1270 Illinois Professional Land Surveyor Act of 1989 Section 1270.57 Standards of Professional Conduct, which states (in part):

"The land surveyor shall undertake to perform land surveying assignments only when qualified by education or experience in the specific technical field of land surveying involved.

The land surveyor may accept an assignment requiring education or experience outside of the land surveyor's field of competence, but only to the extent that services are restricted to those phases of the project in which the land surveyor is qualified. All other phases of the project shall be performed by qualified associates, consultants, or employees.

The land surveyor shall not affix a signature and/or seal to any land surveying plat or document dealing with subject matter in which the land surveyor lacks competence by virtue of insufficient education or experience."

See <http://www.ilga.gov/commission/jcar/admincode/068/068012700000570R.html>.

In accordance with the Code of Ethics for Professional Land Surveyors in the State of Illinois, the Department needs to ensure the highest level of competence in the performance of its work, thus all licensed surveyors working for the Department shall solicit, perform, and sign only work they are trained for, experienced in, or otherwise qualified to perform.

B. SURVEYING CLASSIFICATIONS

B.1 Route Surveying

Route surveying is a branch of surveying concerned with fieldwork and calculations necessary to fix the line and grade of proposed routes of transportation and communications. The Department's definition of Route Surveying can be further divided into "Types" of surveys as further defined in [Section III](#), herein.

Generally, route surveying may be accomplished by employing either ground or aerial surveying procedures and techniques, or a combination of both. Ground surveying policies and procedures are discussed in the Chapters relative to the type of survey being done. Aerial Surveying is further discussed in both a separate Chapter in this Manual, Photogrammetry, [Chapter Six](#), and comprehensive Aerial Mapping standards and procedures are covered in its own Manual.

B.2 Cadastral Surveying

Cadastral surveying deals with the laying off or the measurement of lengths and directions of lines forming the boundaries of land or real property. Cadastral surveys are made for the Department for one or more of the following purposes:

- To secure the necessary data for writing legal descriptions and for finding the area of designated tracts of land.
- To resurvey boundaries of a tract for which a survey has previously been made and for which the description is known.
- To determine the limits of existing right-of-ways and easements as well as determine the limits of new right-of-ways, permanent easements, and temporary construction easements.

Whenever real estate is conveyed from one owner to another, it is necessary to know and identify the location and boundaries of the land conveyed within acceptable limits of certainty. Land acquired for highway improvements changes ownership from private owners to the State of Illinois. Private property owners thus become the neighbors of the newly constructed highway facilities. The maintenance of good relationships with these neighbors is a prime concern of the Department.

II. SURVEY PERSONNEL

Personnel requirements and the composition of a survey crew will normally vary depending on the type of survey to be performed, the topography involved, and the preference of the individual surveyor. For these reasons, it is inappropriate to establish specific guidelines relative to the makeup of a particular survey crew.

The designated leader or crew chief is responsible for organizing the crew, securing the transportation and equipment necessary, and providing for the safety of both the survey crew and the traveling public. He/she is also responsible for the proper use and care of vehicles and equipment assigned to the crew.

Safety of the crew and the motoring public is of utmost importance. [Chapter Twelve](#) of this Manual addresses many of the safety issues that must be strictly adhered to. In addition, references to other Department Manuals in regard to safety is shown.

III. TYPES OF SURVEYS

Generally, the Division of Highways employs seven types of surveys in the process of locating, designing, rehabilitating, and constructing a highway facility on a new or existing location. These are identified and discussed in subsequent paragraphs.

A. CONTROL SURVEYS

Control surveys are surveys accomplished using procedures for second- or third-order work. They are used to provide second-order horizontal and third-order vertical positional data for the support or control of subordinate surveys including ground surveys for aerial mapping. See [Chapter Four](#) for definitions of these Accuracy Standards.

B. LOCATION SURVEYS

Location surveys, as defined by the Department, are general surveys often of two or more feasible corridors. These surveys are performed by Department personnel or consultants, and consist of studying large scale maps, such as (1:2,400) topographic maps, that have contour intervals of 5.0 feet or larger. These maps are normally prepared from a combination of ground surveys and aerial mapping.

C. DESIGN SURVEYS

Design surveys are detailed route locations, sometimes referred to as Preliminary Surveys or Existing Conditions Surveys. These surveys help designers establish the final alignment of the route and provide designers with accurate and specific data required to design the various elements of the proposed highway and to incorporate them into contract plans. See [Chapter Five](#) of this manual for Design Survey requirements.

D. CADASTRAL SURVEYS (LAND SURVEYS)

Cadastral surveys reference land lines and land corners to project control and alignments. This is to facilitate the preparation of Land Acquisition Plats and Conveyance Documents whereby land is purchased. Details are covered in [Chapter Seven](#), on Cadastral (Land) Surveys.

E. CONSTRUCTION SURVEYS

Construction surveys are surveys performed during the construction phase of a project. These surveys represent the transfer of plan details to field staking. The procedures for this transfer are covered in [Chapter Ten](#), Construction Surveys.

F. PHOTOGRAMMETRIC SURVEYS

Photogrammetric surveys are surveys that provide location and/or design survey data acquired from aerial photography. See [Chapter Six](#) for the procedures to perform control work for a Photogrammetric Survey.

G. HYDRAULIC SURVEYS

Hydraulic surveys are necessary to determine bridge and culvert design characteristics. Hydraulic surveys include the location and determination of all pertinent structure data including water surface elevations, flow lines, and under clearance elevations upstream and downstream at any structure within the reach of the survey.

IV. EQUIPMENT

The Department, and most Consultants working for the Department, have made considerable investments in survey equipment of a wide variety.

High Density Laser Scanners (Terrestrial LiDAR), Global Positioning Systems (GPS) of wide variety, total stations, theodolites, and electronic distance measuring equipment, electronic bar code levels, tapes, range poles, and various accessories are available for measurement of distances, angles, and elevations.

GPS equipment is available for establishing horizontal control and vertical control for a variety of applications. GPS is more fully discussed in [Chapter Three](#).

Levels, hand levels, level rods, direct reading rods, and 25-foot long fiberglass telescoping rods are available for use by level crews. Direct reading rods are not considered particularly advantageous for cross sectioning. The 25-foot fiberglass rods are extremely useful in difficult terrain for some operations. They are not acceptable for precise leveling.

Other equipment, although not specifically identified as survey equipment, is necessary for the proper functioning of a survey crew. Equipment in this category includes vehicles, two-way radios, portable computers, portable roadway warning signs, brush cutting equipment, safety vests, ball caps, etc.

V. FIELD NOTE RECORDING

A. GENERAL

Field notes collected by crews using GPS or Total Stations, robotic or otherwise, are often today kept in electronic format. Despite the use of electronic data collection, it is imperative that field crews also record appropriate information in field books.

It is not meant to duplicate the effort of the data collector, but to supplement with details, significant events, or corrections that need to be made to the electronic file and other such important aspects of a field survey. The use and implementation of electronic data collection should not trivialize the importance and significance of good field notes collected to supplement the raw data file in the data collector. The end product of the field survey is the set of notes, which is returned to the office. For this reason, no phase of the surveyor's work is of greater importance, or requires more careful attention than keeping the field notes. The quality of the entire survey is directly reflected in these records. They shall be permanent, legible, and complete and convey only the intended interpretation.

In order that the notes are permanent, they shall be recorded with a fairly hard (3H or 4H) drawing pencil with a sharp point. In accordance with good surveying practice, an incorrect value, once recorded, shall be lined out rather than erased. In order to have field notes legible, they shall be lettered rather than written. The lettering shall be of such size as to permit a reasonable amount of data to be entered on a page without crowding. A further discussion of the manner in which topography and cross section notes should be recorded will be found in [Chapter Three](#).

As the notes are placed in the field book, and as data is collected in a data collector, the Department acquires a very sizable investment in the book and raw data in the collector. Everyone involved in handling the data collected during the survey process is cautioned that great care should be taken with these books and data collectors. The field notes and raw data files in the collectors generally represent the only record of the survey crew's activities and their replacement cost would be considerable. Every reasonable precaution should be taken to ensure the safety of the field books and data collectors. Copies of field books and backups of data files should be made on a daily basis and retained in a separate location, rather than in the possession of the field crew.

B. TYPES OF RECORDING MEDIA

B.1 Book Size

Various types of field books are available; however, by far the most common are the 4½" x 7¼" (114 mm x 184 mm) and the 8½" x 11" loose leaf paper (213 mm x 276 mm) sizes. In the interest of uniformity, all field books prepared by or for the Department should be prepared in either of these size books. The binding should be of canvas or imitation leather and the paper should contain at least 50% high-grade rag stock with a water resisting surface. There should be five red vertical guide lines on the left side for leveling or cross section notes and one red vertical guide line on the right side for topography notes.

B.2 Duplicating

“Duplicating field books” are also available to the above specifications and may be used where applicable. The most common use of “duplicating books” is where the notes must be sent to another agency or office. Some consultants use this type of book in order to retain a record of their notes after the penciled field books have been turned over to the Department.

B.3 Loose Leaf

When loose leaf field books are used, notes may be sent to the office daily or weekly and at the same time allow the field crew to add new data to the books. However, the use of loose leaf field and paperback notebooks is not preferred. In both cases, the poorest feature is the lack of permanency, which is one of the prime requisites for survey notes.

B.4 Electronic Media

When electronic media, such as data collectors, is used to electronically collect and record survey data, the raw data files shall contain the raw and processed data. Included with the digital data should be a list of file names, a description of each file on the digital data file, the software package used, and the version number. For more detailed information on electronic survey data requirements, see [Appendix B](#) of this Manual.

C. INDEXING

Before starting to record notes in a new field book, place a notation on the first leaf of the survey book requesting that if the book is found, it should be returned to the Regional Engineer whose name and address is therein given. To assist the user of the survey book, a map showing the location of the survey may be pasted on the inside of the front cover.

On the second sheet of the book, the names of the various persons in the crew, together with the position that each person occupies, shall appear. The date of the beginning of the survey is also required. The route, section, county, and state job number shall also be shown. Number the double pages in the upper right-hand corner throughout the book. Leave several blank pages in the front of the book in addition to the pages used for the information mentioned above. It is well to leave a half dozen or so pages at the back of the book for additional data that may be required later. Provide the date and weather conditions on the page that begins each day's work.

When the notes in the field book are completed, place an index on the first of the blank sheets that were left in the front of the book. If the book contains level notes, they shall be checked in the field and a note placed on the very last page indicating the name of

the checker and the date. Similar notes shall be made when the centerline elevations and grade rods are computed and checked. On topography notes, the curve data shall be checked and a similar note made.

At times, one of the most difficult tasks in interpreting a survey is determining how the survey began. This information shall be placed on one of the early pages and may require a paragraph of explanation sketches and perhaps cross-references to data on other pages in the book. This information shall indicate what datum has been used (i.e., the National Geodetic Vertical Datum of 1929, the North American Vertical Datum of 1988, or the North American Datum of 1927 or 1983). A discussion of how the stationing was established is required whether the stationing is new, a continuation of previous stationing, or arbitrary stationing.

VI. FIELD COMMUNICATIONS

A. PROPERTY OWNER CONTACT

Members of a survey crew are usually the first representatives of the Department to have personal contact with property owners and/or tenants along the route of a proposed improvement. The impressions they leave will reflect on the Department, and could affect the relationship of right-of-way or construction personnel in the future.

A.1 Verbal

Prior to entering any private property, the crew chief shall contact the owner and/or tenant and explain the purpose, nature, and approximate duration of the proposed work. However, he should refrain from outlining any plans or policies that might be misconstrued. Record personal contacts carefully and accurately for future use. As a minimum, the record should include the names of persons contacted, identifying them as owners or tenants, the date and time of conversation, and a synopsis of the conversation. Telephone numbers for future contact are especially useful.

A.2 Written

Verbally advising a property owner or tenant of the time and reason of any proposed entry on his property will normally suffice. However, it may be advantageous to notify owners of property in highway corridors in writing well in advance of a pending survey or soil sampling expedition. The written notification shall include the assurance that the Department guarantees reimbursement for any damages to the property or crops, which may be attributed to the entry of Department personnel. [Page 1-13](#) illustrates a sample letter that may be used for notification.

B. RIGHT OF ENTRY

B.1 Right to Enter

Survey crews, as representatives of the Department, have a right to enter upon the lands or waters of any person, after the owner has been notified; however, such entry is subject to responsibility for all damages which may result from such entry. See 605 ILCS 5/4-503 of the Illinois Compiled Statutes, or Chapter 121, Section 4-503 of the Highway Code, which states:

“For the purpose of making subsoil surveys, preliminary surveys, and determinations of the amount and extent of such land, rights, or other property required, the Department, or any county, by its offices, agents or employees, after written notice to the known owners and occupants, if any, may enter upon the lands or waters of any person, but subject to responsibility for all damages which shall be occasioned thereby.”

Statutory provisions for general entry upon property by surveyors are also contained in the Illinois Professional Surveyor Act of 1989 ([225 ILCS 330/45](#)).

The surveyor or a member of the survey party shall maintain a record of all damages incurred that shall be given to the BLA engineer/manager upon completion of the survey. The record shall comment on the following as applicable: crop damage (kind, extent, estimated amount) and damage to improvements such as fences, fence posts, gates, trees, shrubs, etc.

B.2 Denial of Entry

In cases where the owner denies a survey party entry to his property, a formal notification letter, making reference to the specific statutes should be sent to him/her by registered mail from the district office. If the owner still refuses entry or challenges the right of entry after receipt of the registered letter, the local law enforcement agency shall be contacted for assistance in gaining entry.

B.3 Damage Claims

To facilitate settlement of any claims for damage to property or crops, which may be attributed to the activities of a survey crew, the crew chief shall annotate any unusual conditions that exist on entry to and departure from any private property. If it is anticipated that a claim may be filed for damages, the crew chief shall report noted conditions to his/her office as soon as possible.

VII. DEFINITIONS

Definitions of some of the common terms used in surveying in the department are listed below.

Alignment: A series of tangents and curves identifying a centerline for an existing or proposed highway.

Azimuth: The direction of one point or object, with respect to another, where the direction of the line is expressed as the clockwise angle from 0° to 360°

Bar-code Level: A digital level instrument designed to electronically read a special leveling rod with a bar-code face. Readings are automatically recorded on an electronic data recorder.

Bench Mark: A relatively permanent material object, bearing a marked point whose elevation above or below an adopted datum is known.

Central Angle: The angle at the center of radius of a circular arc included between the radii that pass through the beginning point (P.C.) and the ending point (P.T.) of the arc. Also known as the delta angle.

Coordinate System: A reference system for defining points in space or on a particular surface by means of distances or angles, or both, with relation to designated axes, planes, or surfaces.

Corner, Quarter Section: A corner midway between the controlling section corners, depending on location within the township.

Corner, Section: A corner established at the junction of surveyed section lines established by the USPLS.

Cross Section: The elevations of the surface of the ground measured along a line perpendicular to the centerline or base line at any given station on the alignment.

Datum: A reference system whereby the position of one point can be directly related to another.

Deflection Angle: The horizontal angle measured from the prolongation of the preceding tangent line, right or left, to the following tangent line.

Digital Terrain Model (DTM): A model of the existing terrain that is developed from elevation data collected with reference to a coordinate system.

Easement: A non-possessing interest held by one person or agency in land of another whereby the first person is accorded partial use of such land for a specific purpose. Easements fall into three broad categories: surface, subsurface, and overhead.

EDMI: An Electronic Distance Measuring Instrument used to measure distances between points by using phase differences between transmitted and returned electromagnetic waves of known frequency and speed.

GPS: The Global Positioning System. The navigational and positioning system that provides location of a position on or above the Earth by a special receiver that interprets signals received simultaneously from several of a constellation of satellites.

Level Circuit: The measurement of elevations commencing on a known elevation point and ending on a known elevation point.

Leveling Rod: A straight rod or bar with a flat face graduated in linear units with zero at the bottom, used in measuring the vertical distance between a point on the ground and the horizontal line of sight of a leveling instrument.

NAD83: The North American Datum of 1983. It is an adjustment of the horizontal coordinate system.

NGS: The National Geodetic Survey.

NGVD29: The National Geodetic Vertical Datum of 1929. The vertical adjustment of 1929 and based on mean sea level as determined by several tide gages over a period of several years.

NAVD88: The North American Vertical Datum of 1988. The vertical adjustment of 1988 after re-leveling work was accomplished on approximately 62,000 miles of leveling lines across the nation.

Photogrammetry: A method of surveying that makes measurements of the ground surface using aerial photographs.

Plats, Right-of-Way: A plan of a highway improvement showing the old and new highways and the right-of-way to be acquired.

Point of Curvature (P.C.): The point where a straight alignment ends and circular alignment begins.

Point of Intersection (P.I.): The point where the two tangents of a circular curve meet.

Point of Tangency (P.T.): The point where a circular alignment ends and straight alignment begins.

Point on Back Tangent (POBT): A point on the tangent of a curve between the Point of Curvature (P.C.) and the Point of Intersection (P.I.).

Point on Forward Tangent (POFT): A point on the tangent of a curve between the Point of Tangency (P.T.) and the Point of Intersection (P.I.).

Point on Tangent (P.O.T.): A point on the tangent line that is used in the projection of the tangent line in a forward direction.

Reference Point: A point set and used at a survey point or alignment point to help re-establish it or recover it during a survey or during construction.

Stationing, Highway: A reference system used in highways to designate the distance from the point of beginning of a highway centerline. Normally a point is labeled at some even interval. Plus stations are used to refer to any intermediate point that lies between two full or even station marks.

Survey Point Code: A numerical code system established by the department to allow the surveyor to collect survey design data by electronic means and use a computer aided drafting system to plot the data.

TBM: A temporary bench mark set on a project and used to control elevations for surveys and construction of a highway project.

Total Station: A survey instrument consisting of a theodolite and an EDM built as a composite unit. Survey data can be recorded directly to an electronic recording device.

Trigonometric Leveling: The determination of differences in elevation using trigonometric procedures with observed vertical angles and measured or computed horizontal or inclined distances.

USGS: The United States Geological Survey.

USPLS: The United States Public Land System. It consists of a set of rules by which boundaries and subdivisions of public lands have been established in the United States. The USPLS is often used for designating the location of a parcel of land.

SUBJECT: F.A. Route _____
(S.B.I. Route _____)
Section _____
_____ County

Address

Salutation

This Department is now making a survey for the improvement of F.A. Route _____ (S.B.I. Route _____) and borings for soil samples may also be taken. Our survey crew is working in your vicinity and will find it necessary to cross the property (owned or leased) by you in order to take the necessary measurements and elevations, and/or borings.

Our personnel have been instructed to consult with you before entering upon your land. I am sure you will find the crew courteous and considerate of your rights and will cause you a minimum of inconvenience.

This work may cause some damage to your property or crops. Should you sustain any damages, however, I can assure you that this Department will reimburse you for your loss.

Very truly yours,

District Engineer

CHAPTER TWO

GEODETIC SURVEYING

BUREAU OF DESIGN AND ENVIRONMENT

SURVEY MANUAL

May 2015

CHAPTER TWO

GEODETTIC SURVEYING

Table of Contents

	Page
I. INTRODUCTION TO GEODETTIC REFERENCE FRAMEWORKS	2-1
A. The Need for Geodetic Control.....	2-1
A.1 Federal	2-1
A.2 State	2-2
A.3 Local.....	2-2
B. Types of Geodetic Control.....	2-2
B.1 Horizontal.....	2-2
B.2 Vertical.....	2-3
II. CURRENT STANDARDS AND SPECIFICATIONS FOR GEODETTIC CONTROL NETWORKS.....	2-3
A. Geospatial Positioning Accuracy.....	2-3
III. HORIZONTAL CONTROL.....	2-5
A. Datums.....	2-5
A.1 North American Datum of 1927 (NAD27).....	2-5
A.2 North American Datum of 1983 (NAD83).....	2-5
A.3 Datum Transformations	2-6
B. Projections	2-7
B.1 Transverse Mercator.....	2-7
B.2 Lambert Conformal Conic.....	2-8
B.3 Universal Transverse Mercator	2-8
C. Coordinate Systems.....	2-9
C.1 Geodetic Coordinates.....	2-9
C.2 State Plane Coordinate System.....	2-9
C.3 Universal Transverse Mercator Coordinates.....	2-10
D. Coordinate System Conversions	2-10
D.1 Manual Method.....	2-10
D.2 Automated Method	2-10
D.3 Direct Conversion (Geodetic to State Plane)	2-11
D.4 Inverse Conversion (State Plane to Geodetic).....	2-11
E. Illinois Primary Horizontal Control (Published).....	2-11
E.1 National Geodetic Survey	2-11
E.2 U.S. Geological Survey.....	2-11
F. Illinois Secondary Horizontal Control	2-12

F.1	The Illinois Department of Transportation	2-12
F.2	Other State Agencies	2-12
G.	Monumentation	2-12
G.1	National Geodetic Survey	2-12
G.1.1	3-Dimensional Rod Mark	2-12
G.1.2	Concrete Post	2-13
G.1.3	Drill Hole	2-13
G.2	U.S. Geological Survey	2-13
G.3	Illinois Department of Transportation	2-13
IV.	VERTICAL CONTROL	2-14
A.	Datums	2-14
A.1	National Geodetic Vertical Datum of 1929	2-14
A.2	North American Vertical Datum of 1988	2-14
A.3	Datum Transformations	2-14
B.	Geoid	2-15
C.	Illinois Primary Vertical Control (Published)	2-15
C.1	National Geodetic Survey	2-15
C.2	U.S. Geological Survey	2-16
D.	Illinois Secondary Vertical Control	2-16
D.1	The Illinois Department of Transportation	2-16
D.2	Other State Agencies	2-16
D.3	Army Corps of Engineers	2-16
E.	Monumentation	2-16
E.1	National Geodetic Survey	2-16
E.1.1	3-Dimensional Rod Mark	2-17
E.1.2	Concrete Post	2-17
E.1.3	Drill Hole	2-17
E.2	U.S. Geological Survey	2-17
E.3	Illinois Department of Transportation	2-17
V.	SOURCES FOR OBTAINING CONTROL DATA	2-17
A.	National Geodetic Survey	2-17
A.1	Headquarters	2-18
A.2	NGS Geodetic Advisor	2-18
A.3	Formats	2-18
A.3.1	Horizontal	2-18
A.3.2	Vertical	2-19
B.	U.S. Geological Survey	2-19
B.1	Headquarters	2-19
B.2	Mid-Continent Mapping Center	2-19
B.3	Formats	2-19
B.3.1	Horizontal	2-19

B.3.2 Vertical 2-19

B.4 Illinois State Geological Survey..... 2-20

C. Illinois Department of Transportation..... 2-20

 C.1 Headquarters..... 2-20

 C.2 Districts..... 2-20

 C.3 Formats 2-20

FIGURES

Transverse Mercator Projection (Figure 2.1) 2-21

Lambert Conformal Projection (Figure 2.2) 2-22

Schematic of the NGS 3D Marker (Figure 2.3)..... 2-23

USGS & NGS Bench Marks Resetting Method (Figure 2.4) 2-24

Geoid-Ellipsoid Surface Relationships (Figure 2.5) 2-25

Permanent Survey Markers (Figure 2.6) 2-26

NGS Data Sheet-Horizontal Mark (Figure 2.7-1 to 2.7-3).....2-27 to 2-29

NGS Data Sheet-Vertical Mark (Figure 2.8-1 to 2.8-2).....2-30 to 2-31

Sample USGS Bench Mark Data Sheet (Figure 2.9)..... 2-32

CHAPTER TWO

GEODETIC SURVEYING

I. INTRODUCTION TO GEODETIC REFERENCE FRAMEWORKS

A. THE NEED FOR GEODETIC CONTROL

In order to permit the many and varied surveying, mapping, and charting programs to be referenced to some common systems, it is necessary to have a common reference framework of control points. An accurate framework can be useful for the various levels of users.

A brief synopsis of the principals of Geodesy as well as current acceptable methodologies and policies are included within this Chapter for the user's review. All users of this Manual are encouraged to expand their knowledge of the principals of geodetic surveys through independent study. It is not necessary to be a Geodesist in order to understand and comply with the policies and standards that will be more fully discussed in this Chapter. While the Department does not generally engage its staff or consultants to perform Geodetic Surveys in the strictest definition, the Department does require a thorough understanding of the principals in order to facilitate the use of the current National Spatial Reference System (NSRS) in the surveys it requires for its projects. The NSRS through the use of Illinois State Plane Coordinates has been officially adopted as the Department's reference framework.

A.1 Federal

At the federal level the National Oceanic and Atmospheric Administration (NOAA), National Ocean Service (NOS), the parent agency of the National Geodetic Survey (NGS), publishes aeronautical charts and ocean navigation charts while the U.S. Geological Survey publishes various scales of quadrangle maps covering the entire nation. All of these products have a common reference system.

In 1970 a reorganization of the U.S. Coast and Geodetic Survey (USC&GS) created the National Oceanic and Atmospheric Administration (NOAA), and the National Ocean Service (NOS) was created as a line office of NOAA. To acknowledge the geodetic portion of NOAA's mission, the part of NOS responsible for geodetic functions was named the National Geodetic Survey (NGS). NOAA's NGS is charged with the task of defining, maintaining, and providing access to the National Spatial Reference System (NSRS).

A.2 State

At the state level various state departments have developed maps for their use and all need to be referenced to a common system for continuity and ease of data exchange.

The Department has mandated the use of the NSRS and adopted the Illinois State Plane Coordinate System (SPC) as the reference system of choice for its projects.

A.3 Local

Many local agencies wish to have their maps compatible with the state and federal agencies, and have used a variety of reference systems, the majority of which is the Illinois State Plane Coordinate System.

B. TYPES OF GEODETTIC CONTROL

There are three basic types of geodetic control: horizontal, vertical, and gravity. The Department does not perform gravity surveys, therefore, they will not be discussed in this manual. If information is required for gravity surveys, please consult the document from the Federal Geodetic Control Subcommittee titled "Standards and Specifications for Geodetic Control Networks," dated September 1984.

B.1 Horizontal

All values for horizontal control in the United States are based on the horizontal control networks established by the National Geodetic Survey. Horizontal geodetic control data consist of distances, directions, and angles between control stations. This data is used to determine geodetic coordinates and azimuths. The geodetic coordinates (Latitude and Longitude) can be converted to other coordinate systems.

B.2 Vertical

Vertical control networks have been established to provide a means of referencing heights of stations above a specified surface.

The height is measured along the direction of the plumb line between the point and the reference surface. The reference surface is the geoid, which closely approximates mean sea level. See [page 2-15](#) for the definition of a geoid.

II. CURRENT STANDARDS AND SPECIFICATIONS FOR GEODETIC CONTROL NETWORKS

A. GEOSPATIAL POSITIONING ACCURACY

Geodetic control surveys are performed to establish a control network from which supplemental surveying and mapping is performed. Geodetic network surveys are permanently monumented control points that comprise the framework for the National Spatial Reference System (NSRS). These surveys have been performed to far more rigorous accuracy and quality assurance standards than those necessary for control surveys for general engineering, construction, or topographic mapping purposes. Geodetic network surveys included in the NSRS are performed to meet requirements established by the Federal Geodetic Control Subcommittee (FGCS).

The Federal Geographic Data Committee (FGDC) introduced Draft “Geospatial Positioning Accuracy Standards” which recognized that the current accuracy standards were no longer valid. The advent of Global Navigation Satellite System (GNSS) surveys and the incorporation of that data into the classical geodetic data made it clear that new accuracy standards should be considered. A new way of thinking about accuracy was developed to help solve the following geospatial concerns:

- Accuracy of different types of spatial data (e.g., survey, cartographic, etc.) was described differently.
- Accuracy of geodetic (survey) spatial data determined using different methodologies.
 - Classical horizontal (e.g., triangulation and traverse)
 - Classical vertical (e.g., leveling)
 - GPS
- Accuracy of new survey technology (i.e., GPS) is not consistent with classical accuracy methodology (i.e., based on distance).
- Accuracy classification of survey data under old system is not consistent with what GIS users want.
 - Local accuracy
 - Network accuracy

Draft accuracy standards for geodetic networks developed by the FGCS Methodology Work Group, Federal Geographic Data Committee, were released for public review through the FGCS and evolved into the final form. The National Geodetic Survey (NGS) has adopted these new standards and now reports accuracy on its Data Sheets in this format.

The network accuracy of a control point is a number, expressed in centimeters, that represents the uncertainty in the coordinates, at the 95% confidence level, of this control point with respect to the geodetic datum. For NSRS network accuracy classification, the datum is considered to be best expressed by the geodetic values at the Continuously Operating Reference Stations (CORS) supported by NGS. The CORS network is an "active" control system consisting of permanently mounted GNSS antennas, and it is the geometric foundation of the NSRS. The local and network accuracy values at CORS sites are considered to be infinitesimal, i.e., to approach zero.

As part of continuing efforts to improve the NSRS, on June 30, 2012, NGS completed the National Adjustment of 2011 Project. This project was a nationwide adjustment of NGS "passive" control (physical marks that can be occupied with survey equipment, such as brass disk bench marks) positioned using Global Navigation Satellite System (GNSS) technology. The adjustment was constrained to current North American Datum of 1983 (NAD83) latitude, longitude, and ellipsoid heights of NGS Continuously Operating Reference Stations (CORS). Constraining the adjustment to the CORS optimally aligned the GNSS passive control with the active control, providing a unified reference frame to serve the nation's geometric positioning needs.

Current NAD83 CORS coordinates were determined by re-processing all CORS data collected from January 1994 to April 2011 in the NGS initial Multi-Year CORS Solution (MYCS1) project. The resulting CORS coordinates were published by NGS in September, 2011, and constitute a new realization referred to as NAD83 (2011/PA11/MA11) epoch 2010.00. The realization name has two parts: the datum tag in parentheses after NAD83, and the epoch date in decimal years. The datum tag refers to the year the realization was completed (2011) and the tectonic plate to which the coordinates are referenced (2011 refers to the North America plate, PA11 to the Pacific plate and MA11 to the Mariana plate). The epoch date indicates that the published coordinates represent the location of the control stations on January 1, 2010, an important consideration in tectonically active areas (such as the western U.S.). In this way, the CORS coordinates (and thus the passive marks constrained to the CORS) are consistent across both space and time. Additional information on the MYCS1 realization of NAD83 is available on the NGS CORS Coordinates web page.

Note that on the current data sheets published by NGS, “Horiz” and “Ellip” values are accuracies at 95% confidence per the FGDC accuracy standards. The values of “Std N,” “Std E,” and “Std h” are the standard deviations (one sigma) of the coordinates (NETWORK) or of the difference in the coordinates (LOCAL) in Latitude, Longitude, and Ellipsoid Height. The value “Correltn NE” is the correlation coefficient between the latitude and longitude components of either the coordinate (NETWORK) or coordinate difference (LOCAL). The “Dist” value is the three-dimensional straight-line slope distance, in km, between a station and the corresponding Local station. Local stations include any other station, regardless of distance, that has been processed simultaneously with the station, in any project.

While these new accuracy standards supersede and replace the accuracy standards from FGCC 1984 and FGCC 1988, they are meant to primarily facilitate the existing and future NSRS. Separate and distinct guidelines are recommended for engineering and construction. Therefore, the Department has officially adopted, by way of this manual, separate and distinct accuracy standards to be used to establish project control and data collection for its projects. Please see [Chapter Four](#) for further details.

III. HORIZONTAL CONTROL

A. DATUMS

A.1 North American Datum of 1927 (NAD27)

The United States Coast and Geodetic Survey now known as the National Geodetic Survey (NGS) did the first adjustment of a national geographic positional system in 1927. This adjustment is based on a reference surface defined by Clarke's spheroid of 1866. A triangulation station, Meade's Ranch, in the central part of Kansas was assigned specific values in latitude and longitude. The azimuth line from Meade's Ranch to station Waldo was assigned a fixed value. All NAD27 geographic coordinates for the triangulation network established by the NGS were originally based on the values assigned to the station, Meade's Ranch.

A.2 North American Datum of 1983 (NAD83)

The North American Datum of 1983 is a readjustment of the geographic positions of the geodetic network of stations based on a reference ellipsoid defined by the Geodetic Reference System of 1980 (GRS80). New geodetic coordinates were produced for all horizontal control points in the network.

The readjustment was done because the NAD27 values no longer provided the quality of horizontal control required by surveyors and engineers.

From 1927 until 1983 many years of geodetic observations were accomplished and added to the basic network. Technology improvement provided more accurate results. Additional base lines were measured using Electronic Distance Measuring Instruments (EDMI) and Very Long Baseline Interferometry (VLBI) technology. This all improved the internal consistency of the network.

A new definition of the ellipsoid (GRS80) that better approximates the Earth's true size and shape was developed. It replaced Clarke's spheroid of 1866 definition, which had been designed as a best fit for the shape of the Earth across North America. The GRS80 reference system was originally used by the [World Geodetic System 1984](#) (WGS84). The reference ellipsoid of WGS84 now differs slightly due to its later refinements.

The origin of the datum moved from station Meade's Ranch to the Earth's center of mass. This provides for a better compatibility with the GNSS.

A.3 Datum Transformations

At times there may be a need to transform coordinate values in one datum to another datum. The NGS has software available (GPPCGP for NAD27 and SPCS83 for NAD83 to convert coordinates from latitude and longitude to state plane coordinates and the reverse. NADCON is a software program that converts geographic positions from an older NGS datum to NAD83. UTMS is a program to convert NAD83 latitude and longitude to UTM coordinates. The Corps of Engineers has combined the four programs mentioned above. It is called CORPSCON. It will transform coordinates between NAD27 and NAD83 for the following types of coordinate sets: Geographic, State Plane, and Universal Transverse Mercator. CORPSCON also includes VERTCON to convert NGVD29 elevations to NAVD88 and reverse. This software is available from the NGS website (www.ngs.noaa.gov). The software comes with documentation on how to run it.

There is no direct mathematical method to accurately transform coordinates from one system to the other. Data conversion programs such as NADCON, developed by NGS, and CORPSCON, developed by the Army Corps of Engineers, are only approximations that are not accurate enough for boundary or engineering surveys. With a general accuracy of 12 cm to 18 cm (0.39 foot to 0.59 foot), these programs are satisfactory for some map conversions but should not be used to convert previous datum points to new.

B. PROJECTIONS

B.1 Transverse Mercator

The Transverse Mercator projection is a modification of the Mercator projection. It was designed for use in states with their greatest dimension lying in a north-south direction. The projection is used as the basis for the state plane coordinate system in Illinois.

The projection consists of a cylinder that has its axis rotated 90° from that used in the Mercator projection. In the Mercator projection the axis of the cylinder is coincident with the axis of the Earth. Its radius is slightly smaller causing it to cut the ellipsoid's surface along two meridians. [See Figure 2.1, page 2-21](#) for an example of the Transverse Mercator projection.

The projection has the following characteristics:

- The scale of the projection is exact along the two meridians where the cylinder cuts the ellipsoid's surface.
- The scale is too large for the zones outside of the two meridians and too small for the zone included between the two meridians.
- The projection can be extended indefinitely in a north-south direction without changing the scale relations.
- The scale changes rapidly in an east-west direction.

B.2 Lambert Conformal Conic

The Lambert projection is a conic projection consisting of an imaginary cone whose central axis is assumed to be coincident with the axis of the earth. The surface of the cone cuts the surface of the ellipsoid at two standard parallels. It was designed for use in states with their greatest dimension in an east-west direction. See [Figure 2.2, page 2-22](#) for an example of the Lambert Conformal Conic projection.

When the surface of the cone is developed into a plane surface the central meridian is given an assigned longitude. The projections from the Earth's surface onto the cone are made along radii from the Earth's center.

The projection has the following characteristics:

- The longitude scale along the standard parallels is exact.
- The conical surface is very nearly coincident with the Earth's surface.
- The latitude and longitude scales are so nearly exact that angles between lines on the projection are very nearly the same as the angles between the same lines on the Earth's surface.
- Between the standard parallels the scale of the projection is too small, while outside of the standard parallels the scale is too large.
- The projection can be extended indefinitely in an east-west direction without affecting the accuracy of the projection.
- The scale changes very rapidly in a north-south direction.

B.3 Universal Transverse Mercator (UTM)

The Universal Transverse Mercator projection is a special case of the Transverse Mercator projection used as a basis for the UTM grid. The grid consists of 60 north-south zones, each 6° wide in longitude, with the longitudes of the boundary edges integral multiples of 6° . The longitudes of the central meridians are therefore odd multiples of 3° . The zones are numbered from 1 to 60 starting at 180° West Longitude and increasing easterly to 180° East Longitude. (Definitions of Surveying and Associated Terms, ACSM 1972).

C. COORDINATE SYSTEMS

C.1 Geodetic Coordinates

Geodetic coordinates are given in latitude and longitude, which define a position of a point on the surface of the earth with respect to the reference spheroid or ellipsoid. They are also known as geographic coordinates.

C.2 State Plane Coordinate System

The State Plane Coordinate System is a plane-rectangular coordinate system established by the U.S. Coast & Geodetic Survey, the predecessor of the National Geodetic Survey. A system has been designed for each state in the United States. It is used to define positions of geodetic stations in terms of a plane-rectangular (X and Y) coordinate system. Most states are divided into areas called zones. Each zone has its own state plane coordinate definition.

One or more zones cover each state, over each of which is placed a grid imposed upon a conformal map projection. The relationship between the grid and the map projection is established by mathematical analysis. Zones of limited east-west dimension and indefinite north-south extent use the Transverse Mercator map projection as the base for the state coordinate system. Zones for which the above order of magnitude is reversed have the Lambert conformal conic map projection with two standard parallels. Only adjusted positions on the North American datum of 1927 and 1983 may be transformed into plane coordinates on a state system.

The state plane coordinate system was designed to enable surveyors and engineers to connect their land or engineering surveys to a common reference system, NAD27 or NAD83. For more details on the state plane coordinate system and its development, see the publication of NOAA Manual NOS NGS 5, State Plane Coordinate System of 1983 by James E. Stem.

The Department, as of August 1, 1988, has required the use of the geodetic coordinate values from the NAD83 adjustment. The requirement pertains to all projects using Illinois State Plane Coordinates as a coordinate system.

C.3 Universal Transverse Mercator (UTM) Coordinates

The UTM coordinate system is a plane-rectangular coordinate system designed for worldwide coverage between latitudes 84°N and 80°S. The polar areas are covered by the Universal Polar Stereographic (UPS) grid. (Definitions of Surveying and Associated Terms, ACSM 1972). The UTM coordinate system is not considered accurate enough for controlling highway projects in the Department, because it covers large areas of the Earth's surface requiring a greater projection and therefore a larger distortion.

D. COORDINATE SYSTEM CONVERSIONS

Geodetic coordinates are not readily usable to the local surveyor who wants to use a plane-rectangular coordinate system for land surveys or engineering surveys. To be able to use a geodetic coordinate as published by the NGS, the geodetic coordinate must be converted to a plane-rectangular grid system. Two methods are used to do this. They are the Manual and Automated Methods.

D.1 Manual Method

The manual method of conversion is a combination of simple equations, tables, and intermediate numerical input requiring only a calculator capable of basic arithmetic operations. See NGS Publication 303 for an example of how to convert a coordinate value manually.

D.2 Automated Method

The Automated method of conversion consists of equations that have been sequenced and structured to facilitate computer programming.

Because the equations apply equally to mainframe and programmable hand-held calculators, the availability of sufficient significant digits warrants consideration. To acquire a copy of the equations, contact the NGS. The NGS programs called NADCON, GPPCGP, and SPCS83 written for the PC will convert geodetic coordinates to state plane coordinates. See [page 2-6](#) for further information on these programs.

D.3 Direct Conversion (Geodetic to State Plane)

This computation starts with the geodetic coordinates of a point (latitude and longitude) from which the Transverse Mercator grid coordinates (N,E) are to be computed.

D.4 Inverse Conversion (State Plane to Geodetic)

In this computation the state plane grid coordinates in the Transverse Mercator system (N,E) are given and the geodetic coordinates are to be computed.

E. ILLINOIS PRIMARY HORIZONTAL CONTROL (PUBLISHED)

There are two federal agencies that are considered the primary sources of monumented horizontal control in Illinois. They are the National Geodetic Survey and the U.S. Geological Survey.

E.1 National Geodetic Survey (NGS)

The National Geodetic Survey has established thousands of control stations to first-, second-, and third-order accuracy in Illinois. This information is published and available to the general public.

E.2 U.S. Geological Survey (USGS)

The U.S. Geological Survey has established monuments in Illinois in connection with its quadrangle mapping program. The USGS has mainly set third-order traverse stations. A few second-order traverse stations have been established

using theodolites and EDM. It is not recommended that USGS monuments be used for horizontal control of projects. The information is published and available to the general public.

F. ILLINOIS SECONDARY HORIZONTAL CONTROL

F.1 The Illinois Department of Transportation (IDOT)

The IDOT has been using state plane coordinates for several years to control highway projects. Most of the coordinates were established to third-order or better accuracy.

F.2 Other State Agencies

Several other state agencies have established state plane coordinates in conjunction with their construction projects. Two of those agencies are the State Water Survey and the Office of Water Resources within the Department of Natural Resources.

G. MONUMENTATION

G.1 National Geodetic Survey

G.1.1 3-Dimensional Rod Mark

A new style for a marker, known as the 3-Dimensional Rod, was designed by the NGS when it started using the Global Positioning System for establishing control stations. The 3-Dimensional rod mark is a mark consisting of a series of 4-foot long stainless steel rods linked together. These rods are driven into the ground with a powered reciprocating driver until the rod refuses to be driven further, or the driving rate of 60 seconds per foot is reached. Refusal is defined as a driving rate of 60 seconds per foot with a 52-pound jackhammer capable of achieving 17.7 foot pounds driving force. These marks are commonly referred to as an NGS 3D Rod Mark. The top section in the freeze thaw area is lined with a sleeve to eliminate the effects of freezing and thawing on the rod.

No disk is used on these marks. The top of the rod is rounded to provide a very precise height for elevation purposes and is accessed through a vault cover.

See [Figure 2.3, page 2-23](#) for an illustration of this type of mark.

G.1.2 Concrete Post

Concrete posts have been used for monumenting high-order survey stations. The NGS normally set a sub-mark under the surface mark for perpetuation. If the surface mark is bumped out of position or moved, the station can be replaced by setting a new surface mark over the sub-mark. See [Figure 2.4, page 2-24](#) (Highway Standard number 668001) for the details of concrete monuments that would be acceptable to the Department.

G.1.3 Drill Hole

Station disks can be set in drill holes made in rock outcropping, concrete bridge piers, etc. A hole is made with a drill and the disk is held in place with mortar or epoxy.

G.2 U.S. Geological Survey

The U.S. Geological Survey has been the primary mapping agency of the United States. They have run third-order and some second-order control for this purpose. Their primary traverse stations have been monumented with concrete monuments and disks. They have not and do not set sub-marks.

G.3 Illinois Department of Transportation (IDOT)

The Department uses concrete marks, either pre-cast or poured in place, to monument some of their traverse stations. The previously discussed 3D Rod Mark is the preferred monument and has been used in several Districts to supplement control. Many control points have been marked by a 5/8-inch re-bar with a yellow plastic cap. These should be considered as potential horizontal only control as they do not maintain good vertical position.

IV. VERTICAL CONTROL

A. DATUMS

A.1 National Geodetic Vertical Datum of 1929 (NGVD29)

The NGVD29 was established to provide vertical control in the United States. The general adjustment was originally known as the Sea Level Datum of 1929. The datum is not mean sea level, the geoid or any other equipotential surface. Therefore it was renamed, in 1973, the National Geodetic Vertical Datum of 1929. (Geodetic Glossary by the National Geodetic Survey dated September 1986). Tide gauges were used in conjunction with thousands of kilometers of leveling lines to establish this datum.

A.2 North American Vertical Datum of 1988 (NAVD88)

The NAVD88 was established to replace the NGVD29. The NGVD29 adjustment had been modified many times by using additional data and making regional adjustments with the new data. Several of the older monuments had been destroyed by construction and widening of highways. A large number of the monuments had moved in elevation due to crustal movement, postglacial rebound or uplifting and subsidence due to mining and withdrawal of underground liquids. The Department, as of July 1, 1999, is requiring the NAVD88 be used as the vertical datum of reference for all new surveys by and for the Department.

A.3 Datum Transformations

A program has been developed for the conversion from the NGVD29 to the NAVD88 or the reverse. This program was written by the NGS and is called VERTCON. VERTCON is included in the Corps of Engineers program called CORPSCON. Similar to horizontal transformations, there is no one exact correlation or transformation between vertical datums.

B. GEOID

A surface that coincides with that surface to which the oceans would conform over the entire earth if free to adjust to the combined effect of the Earth's mass attraction and the centrifugal force of the Earth's rotation. It is an irregular surface that is perpendicular at every point to the direction of gravity (the plumb line). It is the surface of reference for astronomical observations and for geodetic leveling. See [Figure 2.5, page 2-25](#) for an illustration of the geoid and its relationship to the ellipsoid and the Earth's surface.

The National Geodetic Survey has released updated models for transforming heights between ellipsoidal coordinates and physical height systems. September 11, 2012 NGS released GEOID 12A. When performing Global Positioning System (GPS) computations, always indicate which Geoid Model was used in the processing of the data.

C. ILLINOIS PRIMARY VERTICAL CONTROL (PUBLISHED)

There are two federal agencies that are considered the primary sources of monumented vertical control in Illinois. They are the National Geodetic Survey and the U.S. Geological Survey.

C.1 National Geodetic Survey (NGS)

The National Geodetic Survey has established thousands of control stations to first- and second-order accuracy in Illinois. This information is published and available to the general public.

In the recent past several years Illinois has been involved in implementing and establishing the "Illinois Height Modernization Program". As part of the "National Height Modernization Program" hundreds of bench marks are being set in Illinois and submitted to NGS for inclusion into the NSRS. As of the current date this program is ongoing. Please visit the NGS website for more detailed information.

C.2 U.S. Geological Survey (USGS)

The U.S. Geological Survey has established monuments in Illinois in connection with its quadrangle mapping program. These monuments were established to meet third-order accuracy. The USGS references its level lines to the National Geodetic Survey's First- and Second-Order level lines. The information is published and available to the general public.

D. ILLINOIS SECONDARY VERTICAL CONTROL

D.1 The Illinois Department of Transportation (IDOT)

The IDOT establishes bench marks to control highway projects. These bench marks are established to third-order accuracy or higher. Not very many permanent markers have ever been set. Contact the appropriate district survey office for information on IDOT bench mark information.

D.2 Other State Agencies

Several other state agencies have established bench marks in conjunction with their design and construction projects. Two of those agencies are the State Water Survey and the Office of Water Resources of the Department of Natural Resources. Their vertical control is normally done to third-order or less standards.

D.3 Army Corps of Engineers

The Army Corps of Engineers has established vertical monuments along the major navigable waterways. They are established to third-order standards and are available from the Corps of Engineers.

E. MONUMENTATION

E.1 National Geodetic Survey

E.1.1 3-Dimensional Rod Mark

See [Section III, HORIZONTAL CONTROL, G.1.1, page 2-12](#) for details of the 3-Dimensional Rod Mark.

E.1.2 Concrete Post

See [Section III, HORIZONTAL CONTROL, G.1.2, page 2-13](#) for details of the concrete mark.

E.1.3 Drill Hole

See [Section III, HORIZONTAL CONTROL, G.1.3, page 2-13](#) for details on the drill hole.

E.2 U.S. Geological Survey

The U.S. Geological Survey is the primary mapping agency for the United States. They establish third-order control for this purpose. The bench mark stations have been monumented with concrete monuments and disks. At times they have used chiseled squares in headwalls and other concrete surfaces, punch holes in the ends of metal culverts, and other semi-permanent objects.

E.3 Illinois Department of Transportation (IDOT)

The IDOT uses concrete marks, either pre-cast or poured in place, to monument some of its traverse stations. Most of the stations have been marked by a 5/8-inch re-bar with a yellow plastic cap. The iron pins can only be used as temporary bench marks during the project. They have no permanency.

V. SOURCES FOR OBTAINING CONTROL DATA

A. NATIONAL GEODETIC SURVEY

A.1 Headquarters

The National Geodetic Survey (NGS) is the primary source for obtaining horizontal and vertical geodetic survey information for the United States. The headquarters is located in Silver Spring, Maryland. The address is: U.S. Department of Commerce, National Oceanic & Atmospheric Administration, National Ocean Service, National Geodetic Survey, Silver Spring, Maryland, 20910. Information can be obtained through their website at: www.ngs.noaa.gov. Categories of information are: aeronautical data, CORS GPS data, data sheets, geodetic tool kits, and PC software. All PC software listed is downloadable over the Internet. Data sheets for all points in the U.S. are available and can be downloaded for printing. Information on all operating CORS stations is available. The geodetic tool kit is a listing of available programs for performing geodetic conversions and other geodetic functions. The NGS website is a very valuable resource for information. It provides several alternatives for searching for information.

A.2 NGS Geodetic Advisor

The State of Illinois is serviced by a Regional geodetic advisor. The advisor has all the information about the NGS horizontal and vertical monuments in Illinois and can furnish them to the surveyor upon request.

A.3 Formats

The descriptions for all stations in Illinois along with coordinates and azimuth information are available online at www.ngs.noaa.gov.

A.3.1 Horizontal

The available descriptions provide all known information about the station, such as: coordinates, elevations, recovery data, type of monument, azimuths to other stations or objects, and notes on the last reported recovery of the station. See an example of a horizontal station in [Figure 2.7-1 to 2.7-3, pages 2-27 to 2-29](#).

A.3.2 Vertical

The vertical descriptions are similar to the horizontal except that no horizontal data is provided. A latitude and longitude may be given but it is usually scaled from a quadrangle map. See an example of a vertical station in [Figure 2.8-1 to 2.8-2, pages 2-30 to 2-31](#).

B. U. S. GEOLOGICAL SURVEY

B.1 Headquarters

The U. S. Geological Survey (USGS) also publishes horizontal and vertical information. The main office is in Washington, DC. Regional centers are located across the U.S.

B.2 Mid-Continent Mapping Center

Information on the stations can be obtained from the USGS at the Mid-Continent Mapping Center in Rolla, MO. Indexing of the control data is based on the name of the original 15' quadrangle for which it was set. The horizontal and vertical data for Illinois can be purchased from the Rolla office.

B.3 Formats

The descriptions and pertinent data about each station in the USGS network are available in paper copy format.

B.3.1 Horizontal

The horizontal stations are of third-order or less accuracy and cannot be used for controlling highway projects.

B.3.2 Vertical

Vertical control normally meets third-order accuracy. An example of USGS bench mark descriptions and station data is illustrated in [Figure 2.9, page 2-32](#).

B.4 Illinois State Geological Survey

The Illinois State Geological Survey located in Urbana, IL, is a distributor of the USGS quadrangle maps that are available in the 7.5-minute format for the entire state of Illinois. The Aerial Surveys Section has a complete set of USGS 7.5-minute quadrangles that are available for use on IDOT highway projects. The quadrangles for Illinois are now available from the USGS in a digital format.

C. ILLINOIS DEPARTMENT OF TRANSPORTATION

C.1 Headquarters

The Illinois Department of Transportation (IDOT) establishes horizontal and vertical control for its highway projects to third-order or higher accuracy.

Much of the control station information can be obtained from the Aerial Surveys Section in the central office in Springfield. The Aerial Surveys Section also has a complete set of station information for the NGS as well as the USGS markers.

C.2 Districts

Each of nine highway district offices has records of control stations established in its respective district. This information can be obtained from each individual district office.

C.3 Formats

The format for the control station information from IDOT is provided in hard copy format for both horizontal and vertical.

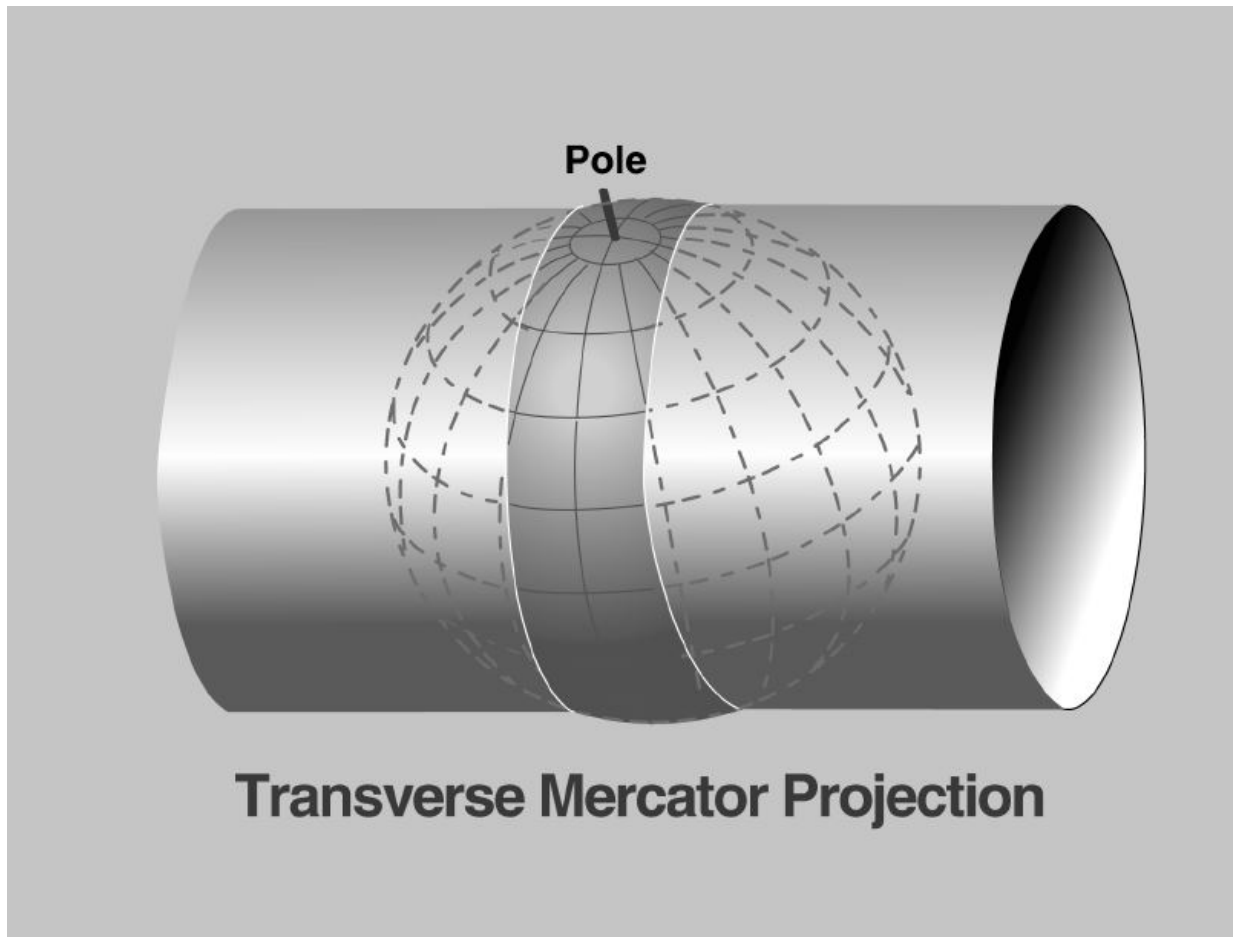

Figure 2.1

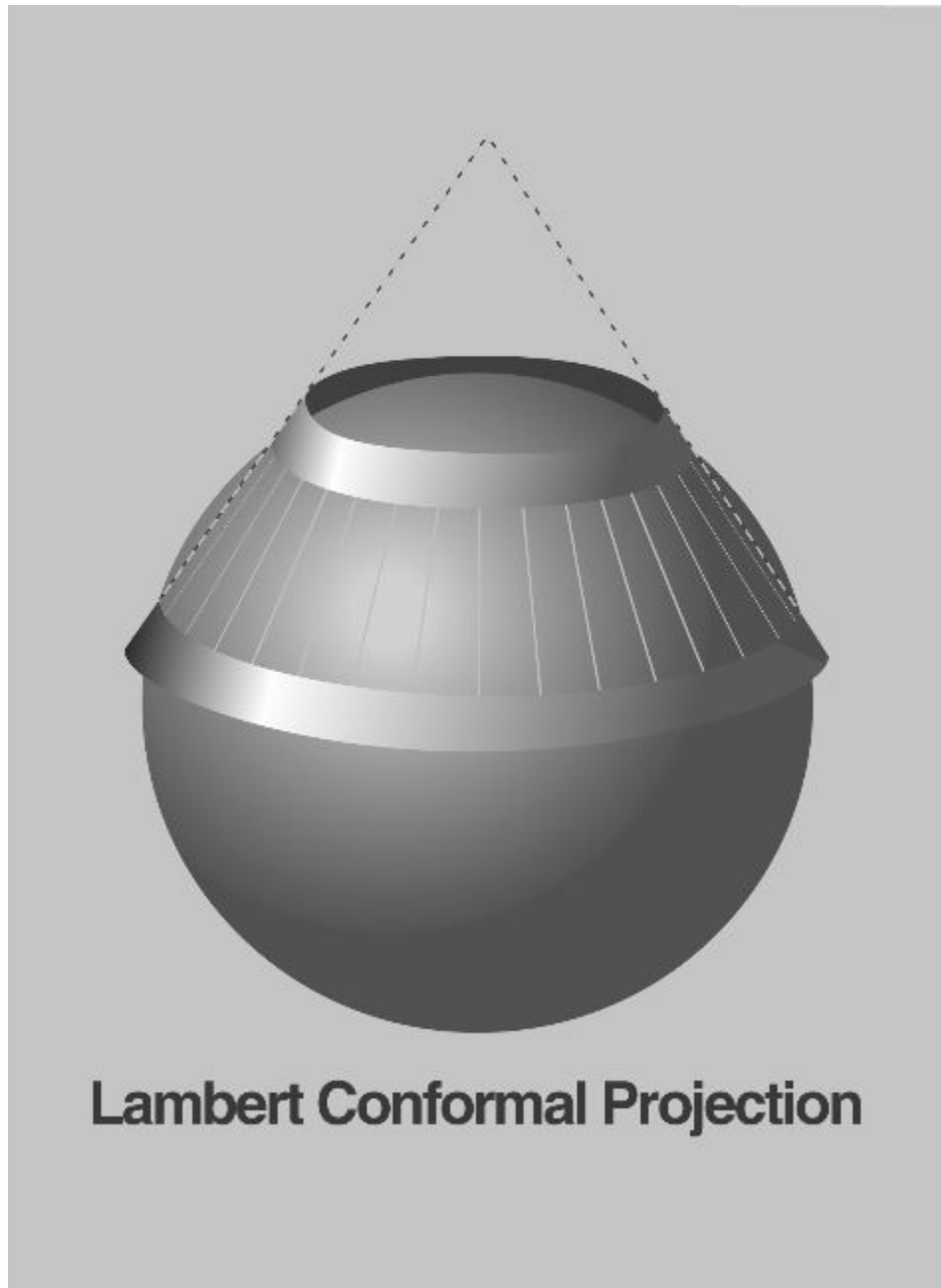

Figure 2.2

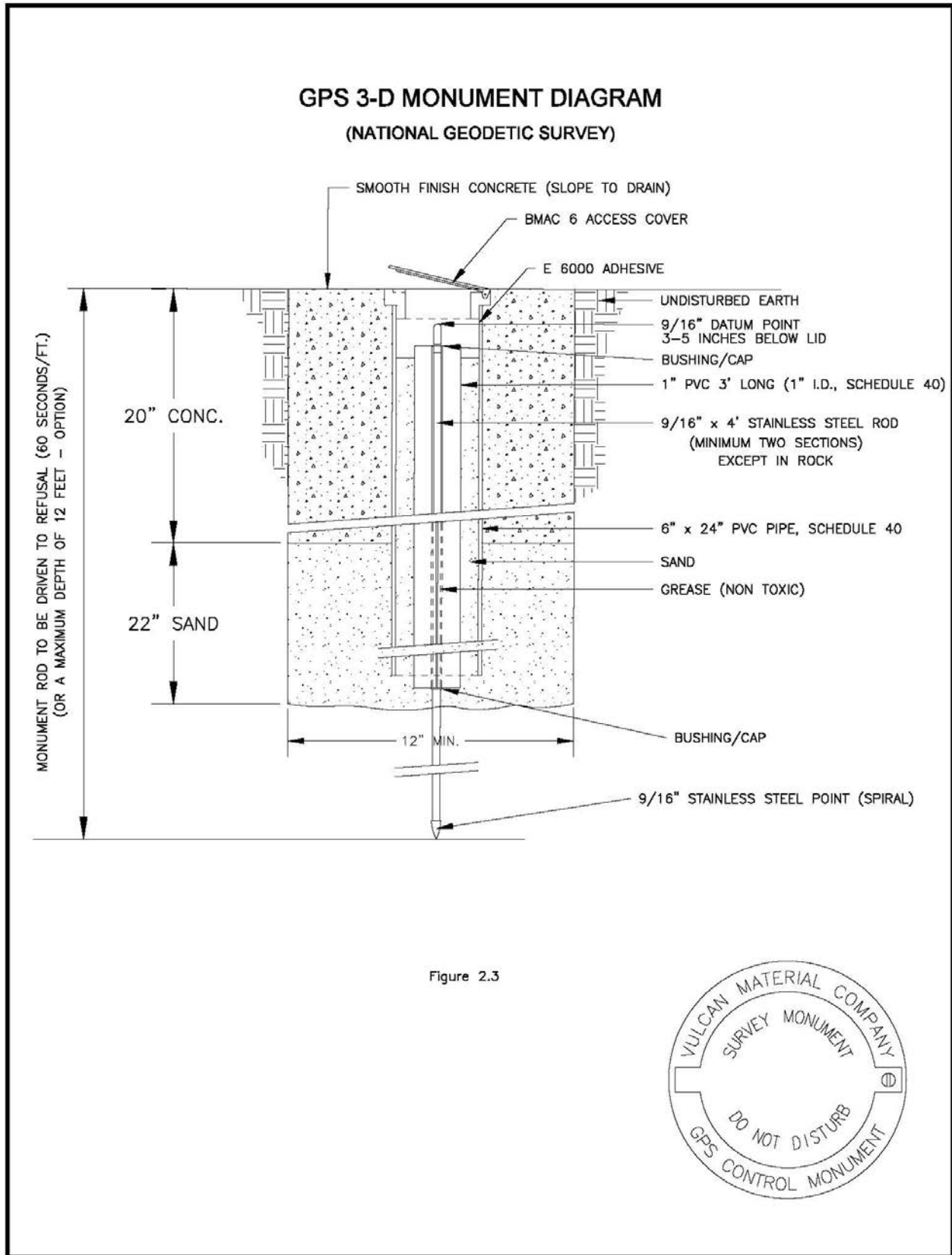
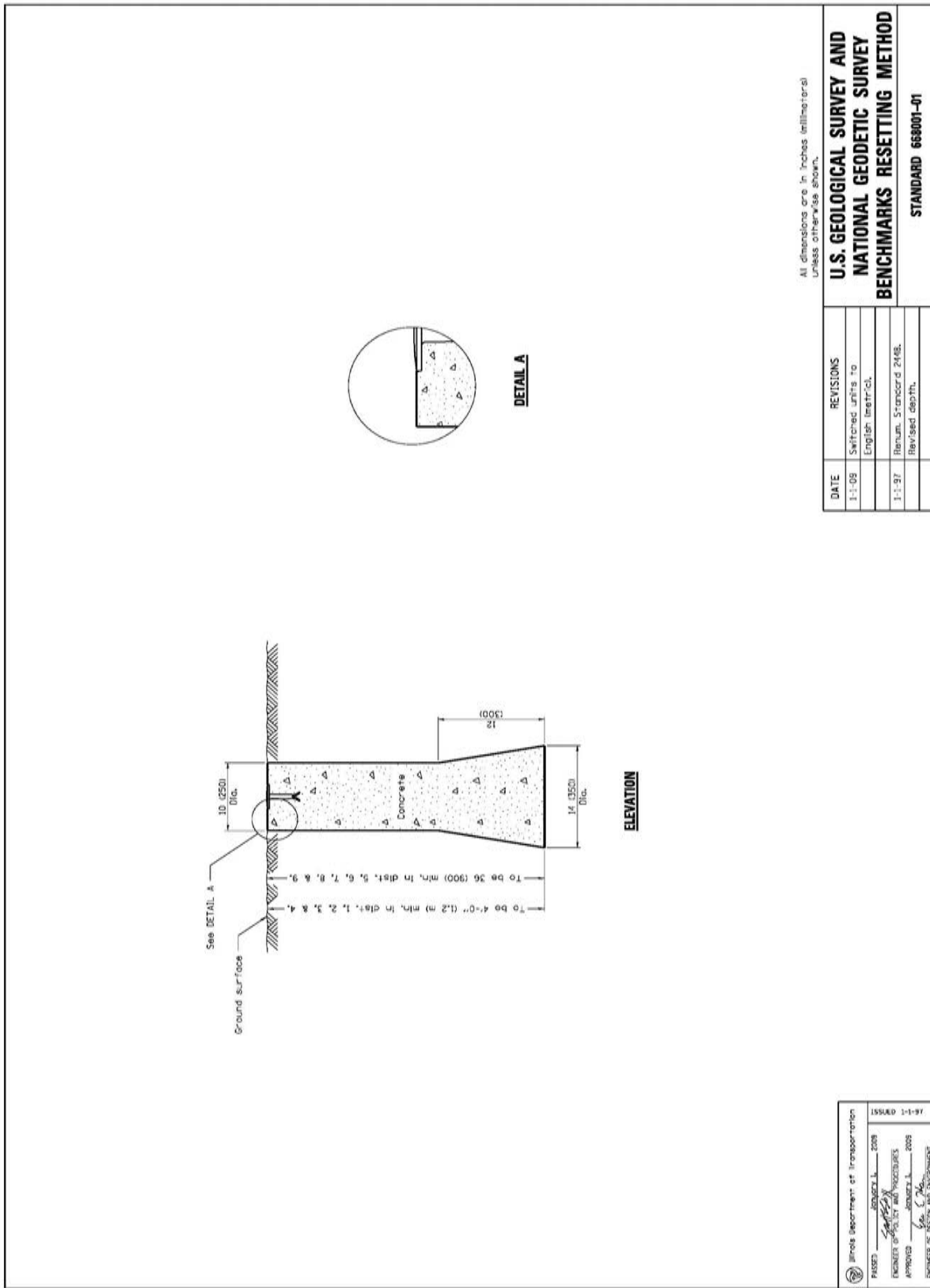

Figure 2.3

Figure 2.3



All dimensions are in inches (millimeter) unless otherwise shown.

DATE	REVISIONS
1-1-09	Switched units to English (metric).
1-1-97	Item. Standard 2165, Revised depth.

U.S. GEOLOGICAL SURVEY AND NATIONAL GEODETTIC SURVEY BENCHMARKS RESETTING METHOD

STANDARD 668001-01

Illinois Department of Transportation
 ISSUED 1-1-97
 PROJECT: _____
 DRAWN BY: _____
 CHECKED BY: _____
 APPROVED BY: _____
 ENGINEER OF DESIGN AND SURVEYING

USGS& NGS BENCH MARKS RESETTING METHOD

Figure 2.4

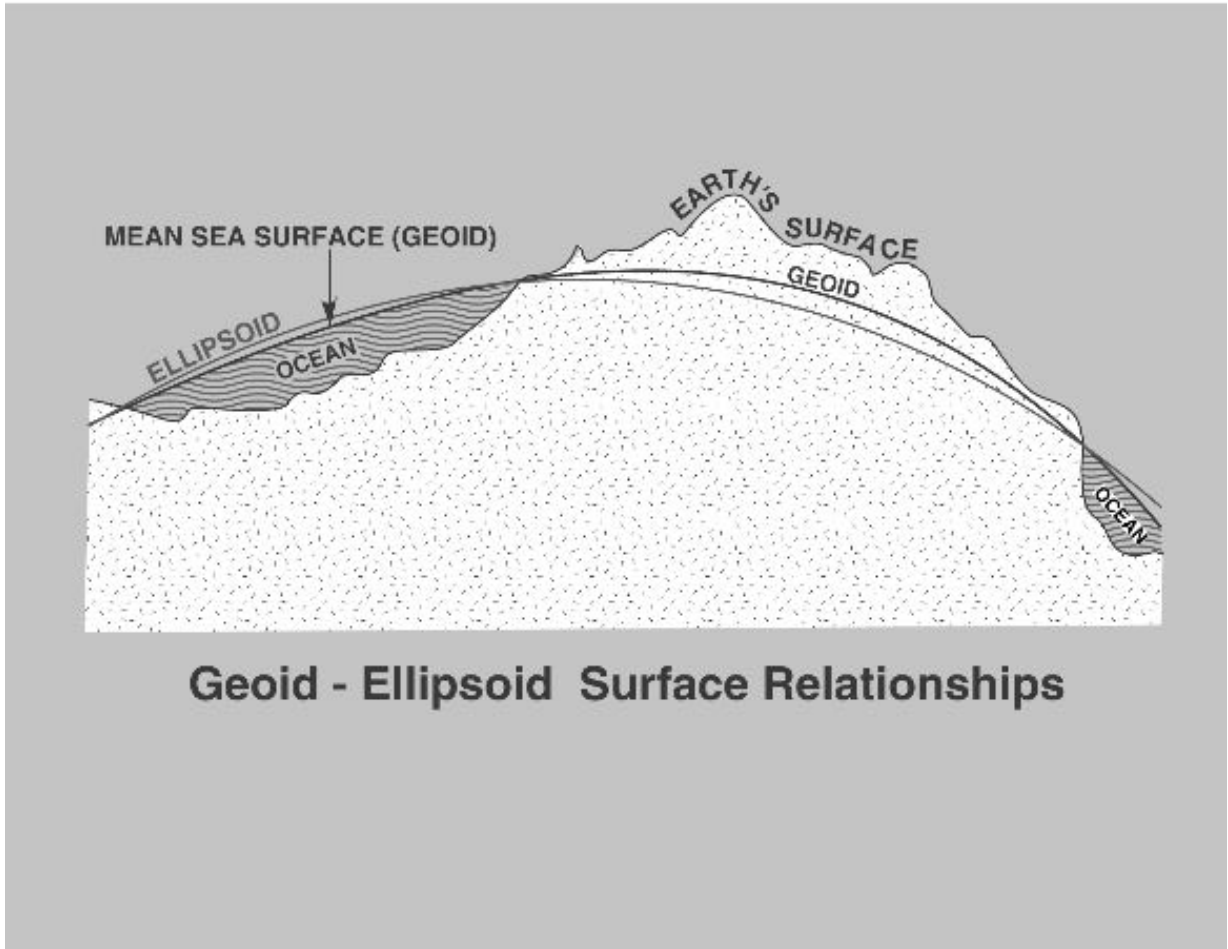
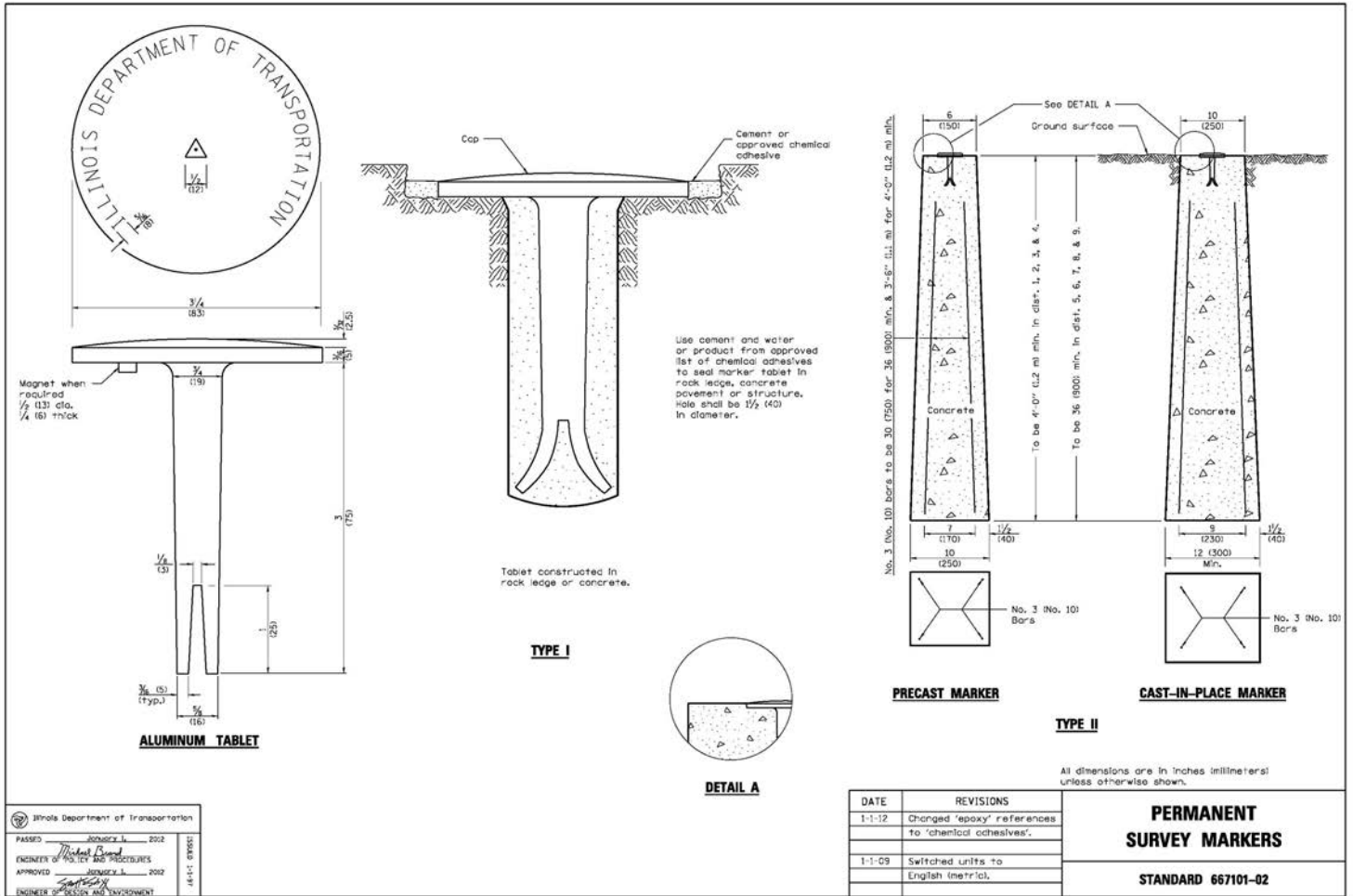

Figure 2.5



PERMANENT SURVEY MARKERS

Figure 2.6

DATASHEETS Data Sheet Retrieval
The NGS Data Sheet

See file dsdata.txt for more information about the datasheet.

PROGRAM = datasheet95, VERSION = 8.3

1 National Geodetic Survey, Retrieval Date = JANUARY 23, 2014

```

AE2486 *****
AE2486 DESIGNATION - WILL COUNTY GPS 1321
AE2486 PID - AE2486
AE2486 STATE/COUNTY- IL/WILL
AE2486 COUNTRY - US
AE2486 USGS QUAD - FRANKFORT (1990)
AE2486
AE2486 *CURRENT SURVEY CONTROL
AE2486
AE2486* NAD 83(2011) POSITION- 41 25 32.04320(N) 087 50 41.80497(W) ADJUSTED
AE2486* NAD 83(2011) ELLIP HT- 194.512 (meters) (06/27/12) ADJUSTED
AE2486* NAD 83(2011) EPOCH - 2010.00
AE2486* NAVD 88 ORTHO HEIGHT - 227.715 (meters) 747.10 (feet) ADJUSTED
AE2486
AE2486 NAD 83(2011) X - 180,107.658 (meters) COMP
AE2486 NAD 83(2011) Y - -4,786,209.988 (meters) COMP
AE2486 NAD 83(2011) Z - 4,198,106.023 (meters) COMP
AE2486 LAPLACE CORR - -1.14 (seconds) DEFLEC12A
AE2486 GEOID HEIGHT - -33.20 (meters) GEOID12A
AE2486 DYNAMIC HEIGHT - 227.623 (meters) 746.79 (feet) COMP
AE2486 MODELED GRAVITY - 980,217.4 (mgal) NAVD 88
AE2486
AE2486 VERT ORDER - SECOND CLASS I
AE2486
AE2486 FGDC Geospatial Positioning Accuracy Standards (95% confidence, cm)
AE2486 Type Horiz Ellip Dist(km)
AE2486 -----
AE2486 NETWORK 1.09 0.86
AE2486 -----
AE2486 MEDIAN LOCAL ACCURACY AND DIST (004 points) 1.05 0.56 4.91
AE2486 -----
AE2486 NOTE: Click here for information on individual local accuracy
AE2486 values and other accuracy information.
AE2486
AE2486
AE2486.The horizontal coordinates were established by GPS observations
AE2486.and adjusted by the National Geodetic Survey in June 2012.
AE2486
AE2486.NAD 83(2011) refers to NAD 83 coordinates where the reference
AE2486.frame has been affixed to the stable North American tectonic plate. See
AE2486.NA2011 for more information.

```

Figure
2.7-1

AE2486

AE2486.The horizontal coordinates are valid at the epoch date displayed above
AE2486.which is a decimal equivalence of Year/Month/Day.

AE2486

AE2486.The orthometric height was determined by differential leveling and
AE2486.adjusted by the NATIONAL GEODETIC SURVEY
AE2486.in August 2012.

AE2486

AE2486.The X, Y, and Z were computed from the position and the ellipsoidal ht.

AE2486

AE2486.The Laplace correction was computed from DEFLEC12A derived deflections.

AE2486

AE2486.The ellipsoidal height was determined by GPS observations

AE2486.and is referenced to NAD 83.

AE2486

AE2486.The dynamic height is computed by dividing the NAVD 88

AE2486.geopotential number by the normal gravity value computed on the

AE2486.Geodetic Reference System of 1980 (GRS 80) ellipsoid at 45

AE2486.degrees latitude (g = 980.6199 gals.).

AE2486

AE2486.The modeled gravity was interpolated from observed gravity values.

AE2486

AE2486. The following values were computed from the NAD 83(2011) position.

AE2486

AE2486; North East Units Scale Factor Converg.

AE2486;SPC IL E - 528,418.430 340,824.185 MT 0.99999550 +0 19 23.3

AE2486;SPC IL E - 1,733,652.80 1,118,187.35 sFT 0.99999550 +0 19 23.3

AE2486;UTM 16 - 4,586,345.309 429,397.469 MT 0.99966134 -0 33 32.7

AE2486

AE2486! - Elev Factor x Scale Factor = Combined Factor

AE2486!SPC IL E - 0.99996949 x 0.99999550 = 0.99996499

AE2486!UTM 16 - 0.99996949 x 0.99966134 = 0.99963084

AE2486

SUPERSEDED SURVEY CONTROL

AE2486

AE2486 NAD 83(2007)- 41 25 32.04325(N) 087 50 41.80589(W) AD(2002.00) 0

AE2486 ELLIP H (02/10/07) 194.531 (m) GP(2002.00)

AE2486 ELLIP H (02/03/05) 194.541 (m) GP() 4 2

AE2486 NAD 83(1997)- 41 25 32.04304(N) 087 50 41.80544(W) AD() 1

AE2486 ELLIP H (10/21/99) 194.544 (m) GP() 4 1

AE2486 NAD 83(1997)- 41 25 32.04305(N) 087 50 41.80555(W) AD() 1

AE2486 NAD 83(1986)- 41 25 32.04546(N) 087 50 41.81908(W) AD() 1

AE2486 NAVD 88 (09/04/97) 227.7 (m) GEOID96 model used GPS OBS

AE2486

AE2486.Superseded values are not recommended for survey control.

AE2486

Figure 2.7-2

AE2486.NGS no longer adjusts projects to the NAD 27 or NGVD 29 datums.
 AE2486.See file dsdata.txt to determine how the superseded data were derived.
 AE2486
 AE2486_U.S. NATIONAL GRID SPATIAL ADDRESS: 16TDL2939786345(NAD 83)
 AE2486
 AE2486_MARKER: F = FLANGE-ENCASED ROD
 AE2486_SETTING: 59 = STAINLESS STEEL ROD IN SLEEVE (10 FT.+)
 AE2486_MARK LOGO: ASCPC
 AE2486_PROJECTION: RECESSED 8 CENTIMETERS
 AE2486_MAGNETIC: I = MARKER IS A STEEL ROD
 AE2486_STABILITY: B = PROBABLY HOLD POSITION/ELEVATION WELL
 AE2486_SATELLITE: THE SITE LOCATION WAS REPORTED AS SUITABLE FOR
 AE2486+SATELLITE: SATELLITE OBSERVATIONS - May 20, 2011
 AE2486_ROD/PIPE-DEPTH: 3 meters
 AE2486_SLEEVE-DEPTH : 1 meters
 AE2486

AE2486 HISTORY	- Date	Condition	Report By
AE2486 HISTORY	- 1997	MONUMENTED	ASCPC
AE2486 HISTORY	- 20110520	GOOD	AMESC
AE2486 HISTORY	- 20120915	GOOD	GEOCAC

 AE2486
 AE2486 STATION DESCRIPTION
 AE2486
 AE2486'DESCRIBED BY AMERICAN SURVEYING CONSULTANTS PC 1997 (PS)
 AE2486'FROM INTERSECTION IL ROUTE 57 AND MANHATTAN-MONEE RD, WEST ON
 AE2486'MANHATTAN-MONEE 4.5 MILES (7.2 KM) TO CENTER RD, TURN SOUTH. STATION
 AE2486'ON RIGHT 150 FEET (45.7 M) FROM INTERSECTION STATION IS FLUSH WITH
 AE2486'SURFACE AND IS STAINLESS ROD WITH SLEEVE WITH CAST CAP AND LID
 AE2486
 AE2486 STATION RECOVERY (2011)
 AE2486
 AE2486'RECOVERY NOTE BY AMERICAN SURVEYING AND ENGINEERING PC 2011 (CF)
 AE2486'RECOVERED AS DESCRIBED.
 AE2486
 AE2486 STATION RECOVERY (2012)
 AE2486
 AE2486'RECOVERY NOTE BY GEOCACHING 2012 (CT)
 AE2486'THE CAP IS BROKEN, BUT THE ROD REMAINS INTACT AND IN DECENT SHAPE.
 *** retrieval complete.
 Elapsed Time = 00:00:04

Figure 2.7-3

DATASHEETS Data Sheet Retrieval
The NGS Data Sheet

See file dsdata.txt for more information about the datasheet.

PROGRAM = datasheet95, VERSION = 8.3

1 National Geodetic Survey, Retrieval Date = JANUARY 23, 2014

DO3744 *****

DO3744 DESIGNATION - WJ 077

DO3744 PID - DO3744

DO3744 STATE/COUNTY- IL/JO DAVIESS

DO3744 COUNTRY - US

DO3744 USGS QUAD - ELIZABETH (1968)

DO3744

DO3744 *CURRENT SURVEY CONTROL

DO3744

DO3744* NAD 83(1986) POSITION- 42 20 33.0 (N) 090 07 50.4 (W) HD_HELD2

DO3744* NAVD 88 ORTHO HEIGHT - 267.733 (meters) 878.39 (feet) ADJUSTED

DO3744

DO3744 GEOID HEIGHT - -33.11 (meters) GEOID12A

DO3744 DYNAMIC HEIGHT - 267.644 (meters) 878.10 (feet) COMP

DO3744 MODELED GRAVITY - 980,281.7 (mgal) NAVD 88

DO3744

DO3744 VERT ORDER - SECOND CLASS I

DO3744

DO3744.The horizontal coordinates were established by autonomous hand held GPS

DO3744.observations and have an estimated accuracy of +/- 10 meters.

DO3744.

DO3744.The orthometric height was determined by differential leveling and

DO3744.adjusted by the NATIONAL GEODETIC SURVEY

DO3744.in March 2013.

DO3744

DO3744.Photographs are available for this station.

DO3744

DO3744.The dynamic height is computed by dividing the NAVD 88

DO3744.geopotential number by the normal gravity value computed on the

DO3744.Geodetic Reference System of 1980 (GRS 80) ellipsoid at 45

DO3744.degrees latitude (g = 980.6199 gals.).

DO3744

DO3744.The modeled gravity was interpolated from observed gravity values.

DO3744

DO3744; North East Units Estimated Accuracy

DO3744;SPC IL W - 630,125. 702,966. MT (+/- 10 meters HH2 GPS)

DO3744

DO3744 SUPERSEDED SURVEY CONTROL

DO3744

DO3744.No superseded survey control is available for this station.

DO3744

DO3744_U.S. NATIONAL GRID SPATIAL ADDRESS: 15TYG3636291792(NAD 83)

DO3744

Figure 2.8-1

DO3744_MARKER: F = FLANGE-ENCASED ROD
DO3744_SETTING: 59 = STAINLESS STEEL ROD IN SLEEVE (10 FT.+))
DO3744_STAMPING: WJ077
DO3744_MARK LOGO: UIL
DO3744_PROJECTION: RECESSED 5 CENTIMETERS
DO3744_MAGNETIC: N = NO MAGNETIC MATERIAL
DO3744_STABILITY: B = PROBABLY HOLD POSITION/ELEVATION WELL
DO3744_SATELLITE: THE SITE LOCATION WAS REPORTED AS SUITABLE FOR
DO3744+SATELLITE: SATELLITE OBSERVATIONS - May 01, 2012
DO3744_ROD/PIPE-DEPTH: 6.1 meters
DO3744_SLEEVE-DEPTH : 0.9 meters
DO3744
DO3744 HISTORY - Date Condition Report By
DO3744 HISTORY - 20120501 MONUMENTED AMESC
DO3744
DO3744 STATION DESCRIPTION
DO3744
DO3744'DESCRIBED BY AMERICAN SURVEYING AND ENGINEERING PC 2012 (BJD)
DO3744'THE STATION IS LOCATED ABOUT 9.7 MI (15.6 KM) NORTH-NORTHWEST OF
DO3744'PLEASANT VALLEY, 6.4 MI (10.3 KM) WEST OF STOCKTON AND 4.9 MI (7.9 KM)
DO3744'EAST-NORTHEAST OF ELIZABETH. OWNERSHIP--ROAD RIGHT-OF-WAY.
DO3744'
DO3744'TO REACH FROM THE INTERSECTION OF ILLINOIS ROUTE 78 SOUTH AND US ROUTE
DO3744'20 PROCEED WEST ON US ROUTE 20 6.75 MI (10.9 KM) TO EVANS ROAD AND THE
DO3744'STATION ON THE LEFT.
DO3744'
DO3744'THE STATION IS 54.5 FT (16.6 M) SOUTH OF THE CENTERLINE OF US ROUTE
DO3744'20, 47 FT (14.3 M) SOUTHEAST OF A DELINEATOR, 6 FT (1.8 M) EAST OF A
DO3744'GRAVEL FIELD ENTRANCE, 6.5 FT (2.0 M) NORTH OF A CONCRETE RIGHT OF WAY
DO3744'MARKER.
DO3744'
DO3744'NOTE-ACCESS TO THE DATUM POINT IS THROUGH A 6-INCH (15 CM) LOGO CAP.
DO3744'THE ROD (DATUM POINT) IS SURROUNDED BY A FLOATING BRONZE DISK TO AID
DO3744'IN IDENTIFICATION.

*** retrieval complete.

Elapsed Time = 00:00:02

Figure 2.8-2

	2
	39-088-44
Sample USGS Bench Mark Data Sheet	DECATUR QUADRANGLE
	128 - ILLINOIS
LINE 1	
<u>K.E. Daly, 1966; Book CV-1986</u>	<u>DECATUR QUAD. – 128</u>
0.0 Decatur, about 0.1 mi S. along Illinois Central RR. from the Wabash Station at, in sec. 21, T. 16 N., R. 3 E., thence about 4.1 mi SE. along U.S. Hwy. 36 from crossing of I.C. RR. at Junction of U.S. Hwy. 36 and State Hwy. 121 S., 29.5 ft N. of center of W. bound lanes of U.S. Hwy. 36, 66 ft NE. of center of junction of State Hwy. 121 and W. bound lanes of Hwy. 36, 61 ft E. of center of asphalt road N. to Decatur Airport, 43 ft S. of S. rail of mainline of Baltimore & Ohio RR. track, 7 ft S. of S. edge of 5 ft manhole cover; in a concrete post flush with ground, a USC&GS standard disk stamped "X 262 1961" (Recovered in good condition)	671.468
0.7 UE X 262 A, 0.75 mi S. along State Hwy. 121 from tablet, T. 16 N., R. 3 E., near S. sixteenth cor. between secs. 28 and 29; 510 ft N. and 30 ft W. of Hwy. at road E.; 1 ft S. of N. end of W. headwall of 12 ft concrete box culvert; a chiseled square	643.20
1.8 Mt. Zion, 1.5 mi N. and 0.3 mi E. of, 1.7 mi S. along State Hwy. 121 from junction of U.S. 36, T. 16 N., R. 3 E.; near center W 1/2. sec. 33, 22.5 ft N., 39.5 ft E. and 2.8 ft higher than Hwy. at E.-W. road, in a concrete post projecting 2-in., a City of Decatur Dept. public property tablet stamped "33 658 33" (Elev. by USGS)	
658.119	
1.8 Reference mark, 386.5 ft S. of tablet, 30 ft E. of road, N. and of E. headwall of 2 ft concrete box culvert; chiseled square	650.23
2.7 UE 33 A, 1 mi S. along Hwy. from tablet, at offset E.-W. road, T. 15 N., R. 3 E., near N. sixteenth cor. between secs. 3 and 4, 17 ft N., 30 ft W. and 0.9 ft higher than T-rd. W. of offset crossroads, center of N. concrete headwall of 1.5 ft culvert; chiseled square	688.71
3.7 UE 33 B, 2 mi S. along State Hwy. 121 from tablet, at road leading W. to Mt. Zion, T. 15 N., R. 3 E., near cor. Secs. 3, 4, 9 and 10, 250 ft NW. along RR., 10 ft NE. of center of RR. and 2.1 ft lower than RR. at E.-W. road crossing; center of N. end and 1 ft S. of N. edge of old concrete semaphore base; chiseled square	697.43
5.2 At Hervey City, on the Pennsylvania RR., at the crossing of State Hwy. 121, 16.5 Poles W. of milepost 84, 30 ft N. of main track, 27 ft E. of edge of pavement; the top of a valve set in the top of a concrete post, stamped "BM 8" (ISHD) (Recovered as described in good condition)	699.073
 LINE 2 	
<u>K.E. Daly, 1966; Book CV-1986</u>	<u>DECATUR QUAD. – 128</u>
0.0 Decatur, about 0.1 mi S. along I.C. RR. from the Wabash Station at, thence about 4.1 mi SE. along U.S. Hwy. 36 from the crossing of the I.C. RR., thence about 0.95 mi N. along asphalt road known as the airport road, in sec. 21, T. 16 N., R. 3 E., set in top of SW. cor. of the 6 x 10 ft concrete box around and over water mains for the airport, 240 ft SW. of SW. cor. Of the service hangar; 88 ft E. of the center of the asphalt road known as the airport road, 19 ft S. of the extended centerline of Cantrell St. leading W., about 4-in. above ground, a USC&GS standard disk stamped "Z 262 1961"	676.557
0.7 Antioch, 1.6 mi N. and 0.5 mi W. of, 1.6 mi N. of junction of State Hwy. 121 and U.S. Hwy. 36, at intersection of Mt. Zion Road and N. country Club Road; T. 16 N., R. 3 E., near quarter cor. between secs. 16 and 17, 33.5 ft S., 43 ft E. and 1.5 ft higher than T-street S., in a concrete post projecting 2-in., a City of Decatur Dept. Public Property tablet stamped "17-671.77" (Elev. by USC&GS)	671.471

Figure 2.9

CHAPTER THREE

GPS

BUREAU OF DESIGN AND ENVIRONMENT
SURVEY MANUAL

May 2015

CHAPTER THREE

GPS

Table of Contents

	Page
I. INTRODUCTION.....	3-1
A. General Categories of GNSS Surveys	3-2
A.1 Post-Processed GNSS Surveys	3-2
A.2 Real-Time Kinematic GNSS Surveys	3-2
II. POST-PROCESSED GNSS SURVEYS	3-2
A. Equipment	3-3
A.1 GNSS Receivers	3-3
A.2 GNSS Antennas.....	3-3
A.3 Supplemental Equipment and Accessories	3-3
A.4 Office Equipment and Accessories.....	3-4
B. General Methods and Procedures	3-4
B.1 Survey Methods	3-4
B.2 Network Design and Session Planning.....	3-5
B.3 Overview of Field Procedures	3-6
B.4 Overview of Office Procedures.....	3-7
III. REAL-TIME KINEMATIC (RTK) GNSS SURVEYS	3-7
A. Equipment.....	3-7
A.1 GNSS Receivers	3-7
A.2 GNSS Antennas.....	3-7
A.3 Supplemental Field Equipment and Accessories.....	3-8
A.4 Office Equipment and Accessories	3-8
B. General Methods and Procedures	3-8
B.1 Real-Time Kinematic GNSS Survey Methods.....	3-8
B.2 Real-Time Kinematic GNSS Survey Procedures	3-11
B.3 Overview of Field Procedures	3-15
B.4 Overview of Office Procedures.....	3-16
IV. GNSS FOR CONTROL SURVEYS	3-16
A. Introduction.....	3-16
B. Large Scale Geodetic Control Surveys	3-16
C. Guidelines for Post-Processed GNSS Control Surveys	3-17
D. Long Corridor Control Surveys	3-19
E. Local Control Surveys.....	3-19
V. GNSS FOR DATA COLLECTION AND STAKING SURVEYS.....	3-19
A. Introduction.....	3-19

B. Design and Construction Surveys 3-22
C. Cadastral Surveys 3-22
D. Photo Control and LIDAR Checkpoint Surveys 3-22
VI. REFERENCES 3-23
VII. APPENDICES 3-24
 A. Definitions 3-24
 B. GPS Ellipsoid Height Hierarchy and Basic Guidelines 3-25

CHAPTER THREE

GPS

I. INTRODUCTION

Recent advances in technology have brought great advancements to GPS surveying. The realization of full functionality of the Russian Global Orbiting Navigation Satellite System (GLONASS), in addition to new satellites in the United States Department of Defense NAVSTAR Global Positioning System (GPS), has created the worldwide Global Navigation Satellite System (GNSS). GNSS is now used in virtually every aspect of survey work. Surveyors use GNSS surveying daily to both set new points and collect positions of existing points.

Recent efforts by the National Geodetic Survey (NGS) and the International GNSS Service (IGS), resulting in the publication of the National Adjustment of 2011 and the hybrid geoid model GEOID12A, have yielded new geometric coordinates and velocities on Continuously Operating Reference Stations (CORS). New coordinates have been established on passive stations, or “conventional” ground stations that are more consistent with the CORS. The expansion of Real-Time GNSS Networks and densification of NAVD 88 vertical control being provided by the Illinois Height Modernization program continue to offer increased opportunity for GNSS survey methods.

The Illinois Department of Transportation (i.e., Department) has established the following specifications with full knowledge that the GPS technology is so rapidly changing that there will be equipment and procedures available after this writing that will accomplish the standards outlined, but using different specifications. Department staff or consultants are encouraged to present innovations in both for consideration by the Department. In addition, this Chapter is not meant to be a basic tutorial on GPS. The Department assumes that all users are well trained and experienced in the many aspects of GPS before they are assigned to perform GPS Surveys on any projects of the Department.

A. GENERAL CATEGORIES OF GNSS SURVEYS

A.1 Post-Processed GNSS Surveys

As the name implies, Post-Processed GNSS Surveys are surveys where GNSS data is logged in the field for future processing and analysis. Such surveys require GNSS data to be logged using three or more receivers simultaneously occupying a combination of known and new survey control points. While it is theoretically possible to perform a GPS survey with only two receivers, the Department requires that at least three be used. This ensures that at each session at least two non-trivial vectors are measured.

The raw survey data is later processed and adjusted using proprietary GNSS office software or online systems such as NGS' OPUS and OPUS Projects and Trimble's new CenterPoint RTX post-processing service. Post-Processed GNSS Surveys are required for Geodetic and Large-Scale Control Surveys such as a District or County Control Network, and on surveys of any size where GNSS Surveying is being used to establish new Vertical Control.

A.2 Real-Time Kinematic GNSS Surveys

Real-Time Kinematic (RTK) GNSS Surveys are surveys where GNSS data is logged and simultaneously processed by a rover and data collector capable of receiving GNSS correction data sent by a data transfer link from a GNSS base station. The position of the rover is computed in real time. RTK Surveys include both conventional Single Base-Rover Surveys, which use a Base Receiver occupying a known control point and transmitting correction data to a Roving Receiver via data transfer link, and Real-Time Network (RTN) Surveys, in which correction data is computed using data from a network of continuously operating GNSS base stations and transmitted to the rover by Internet connection.

In practice, surveys are often done using a combination of both Post-Processed and RTK, or RTN, methods. The data memory available in modern GNSS equipment allows full logging of raw data for all GNSS surveys. It is possible to design a survey network that allows the use of Real-Time (RT) methods, with raw data logging enabled and sufficiently long observation sessions to allow for real-time field solution and later post-processing of static base lines and network adjustment. The Real-Time (RTK or RTN) solutions can then be compared with the network solutions as QA/QC.

II. POST-PROCESSED GNSS SURVEYS

A. EQUIPMENT

A.1 GNSS Receivers

Post-Processed GNSS Surveys require GNSS receivers capable of recording raw data. Receivers used shall be appropriate for the specific type of post-processed survey being performed, as specified by the manufacturer. The receivers used shall be dual frequency and shall have the capability of tracking a minimum of five GPS satellites simultaneously. The use of GNSS receivers, which track GLONASS as well as GPS satellites, allows for increased accuracy and shorter occupations due to the improvements in satellite geometry offered by the additional satellites. A minimum of three receivers shall be used simultaneously during all static GPS sessions. Use of more than three receivers yields substantial time savings to larger campaigns. Appropriately located CORS stations can be used in the network and should be included when available.

A.2 GNSS Antennas

If at all possible, all receivers used in a given survey should have identical antennas. If the antenna type employed includes a ground plane it shall be used at all times, as specified by the manufacturer. Antennas shall be mounted on a suitable tripod or tower. Fixed height tripods are mandated for vertical control surveys and are recommended for all static occupations. Fixed height poles supported by a tripod or bipod are recommended for shorter occupations. If fixed height mounts are not used, antenna heights shall be measured in both feet and meters and input measurements verified at the beginning and end of every occupation. Incorrect antenna heights cause large errors in post-processing even on horizontal networks and generally require re-observation of the suspect occupations. It is imperative that the software used for post-processing have the appropriate antenna definitions for the equipment used.

A.3 Supplemental Equipment and Accessories

Poorly maintained equipment is a source of error and wasted time in any survey. All equipment associated with the GNSS survey including tripods, rods, batteries, cables, level vials, optical plummets, etc., shall be kept clean, fully charged, and in good operating order. Dead batteries and shorted cables are notorious for undermining an otherwise well-planned survey mission.

A.4 Office Equipment and Accessories

GNSS post-processing can be done on any computer typically used for CAD applications. The major GNSS equipment vendors provide comprehensive software packages that allow the user to handle all aspects of GNSS data processing. In some cases processing can be done using online services that do not require investment in a full GNSS software package.

B. GENERAL METHODS AND PROCEDURES

B.1 Survey Methods

There are three basic methods of conducting post-processed GNSS surveys: Static Surveys, Fast/Rapid-Static Surveys, and Kinematic (or Stop-and-Go) Surveys. The field techniques are essentially the same for each, but differences in occupation times, network design, and processing methods provide the requisite accuracy for a wide range of survey requirements.

Static GNSS surveys are used when high-accuracy positioning is required. Static surveys allow for solutions of highly accurate base lines between stationary GNSS receivers. Recording data over a period of time in which satellite geometry changes allows for better resolution of systematic errors. The required length of occupation is a function of base line length and number of satellites available. Recommended observation times are discussed later in this Chapter. Static surveys are appropriate for large-scale control surveys, such as District or County control networks or long-corridor control surveys.

Fast/Rapid-static GNSS surveys are similar to static GNSS surveys but use shorter occupation times, typically between 5 and 10 minutes. Allowable base line lengths and expected accuracies are less than those accomplished by static surveys. Fast/Rapid-static survey methods are appropriate for establishing control for photogrammetric, design, and cadastral surveys of small to medium size and where appropriate known control exists close enough to the project area.

Post-processed kinematic GNSS surveys use short observation periods, often three minutes or less, and can be used for base lines under 5 km (3 miles) in length. Post-processed kinematic surveys are not often used but are worthy of considering for control densification and data collection on smaller projects where conditions are not conducive to transfer of real-time correction data from a base.

B.2 Network Design and Session Planning

The first step of network design is the selection of the location of new project control points. The location of the new control points shall depend on the optimum layout to carry out the required needs of the survey. Stations shall be situated in locations with a clear view of the sky and free from horizon obstructions.

Locations near sources of radio transmission or sources of multipath error, such as large, flat surfaces such as buildings and billboards, should be avoided and consideration must be given to the safety of the observer. Vehicles parked close to the station during the survey are sources of multipath errors. Ensure there is a place to park vehicles at least 50 feet from the station.

The second part of network design involves selecting appropriate known points from the NGS database and prior Department projects to control the survey and relate it to both the NSRS and prior Department or other local control. NGS distributes the program DSWorld, which links the NGS database with Google Earth and is an extremely useful planning tool. Checks shall be made to ensure that no existing or known network control points have been moved or disturbed. If any are doubtful, additional existing points shall be tied into the network. The Department encourages consultants to file a recovery report on the NGS website for any NGS station used whose condition varies from the published description.

Proper field reconnaissance is essential during the planning stages of a GNSS survey. This should include the setting of new stations and recovery of known control stations and preparation of suitable field descriptions and reference ties. Good field reconnaissance will provide the needed information for the Project Manager to create the best network design and session plan.

Horizontal networks should be connected to a minimum of three National Geodetic Survey (NGS) stations. The use of eccentric horizontal stations is not permitted. Any CORS stations within a reasonable distance shall be included in the network. If only a horizontal survey is being done, at least one published NAVD 88 control point shall be used and held fixed in the adjustment.

Vertical networks shall be connected to three or more published NAVD 88 control points of first- or second-order accuracy. At least three of the NAVD 88 control points shall be near or outside the boundary of the project to best define the geoid separation for the area. In areas of sparse NGS vertical control, the Department may be able to provide alternative bench marks from prior Department projects.

The use of eccentric vertical stations is permitted provided they are located within 100 meters of the original mark and digital bar-code leveling is used to determine the elevation of the eccentric point.

The existing control, both horizontal and vertical, used to control a network shall lie in a minimum of three quadrants using the geographic center of the project as the reference point.

A session plan detailing specific stations and occupation times should be prepared in advance of field work and distributed to the field crew. Careful execution of the session plan will ensure that no occupations are missed.

B.3 Overview of Field Procedures

After initial reconnaissance, field work on post-processed GNSS surveys consists of collecting observations based on the session plan. Each individual observer shall keep an observation log which records pertinent information on the stations occupied, occupation times, receiver and antenna serial numbers, file names, antenna heights, and any other information deemed appropriate by the Project Manager. The Crew Chief should keep a master observation schedule tracking the individual crew members. Good field notes are essential for office post-processing.

Fixed height tripods or rods are required. Antenna heights must be measured and recorded at the beginning and end of each session. It is imperative that the observer ensures the antenna remains stationary during the session. Use of sandbags or other weights on the tripod legs is recommended when there is a risk of the tripod being blown over.

Observations should not be collected during geomagnetic or electrical storms or during passing weather fronts. The NOAA Space Weather Prediction Center should be consulted to confirm space weather; presently available at <http://www.swpc.noaa.gov>.

The Department requires observation periods of 30 to 60 minutes with dual-frequency receivers. Shorter or longer observations may be allowed based on number of satellites, geometry, and base line length. A minimum of five satellites are required. The satellite mask angle above the horizon should be set to 10 degrees, and a maximum epoch interval of 15 seconds should be used.

B.4 Overview of Office Procedures

Post-Processing of GNSS data consists of four main steps: Base Line Processing, Loop Closure, Repeat Base Line Analysis, and a Least-Squares Adjustment. Review and analysis of the results of each step is required. The Least Squares Adjustment should be performed in a minimum of two steps. A minimally constrained adjustment followed by the fully constrained adjustment together with a detailed report of the results is required as a minimum. The GPS Report may be a part of a more comprehensive Project Survey Report, if appropriate.

Post-processing of static networks currently requires proprietary GNSS software, which is available from various vendors. Some processing can be done without investment in a full GNSS software package by using online services offered by both NGS and private vendors.

The Federal Geodetic Control Committee and NGS have published specifications and guidelines for both field and office procedures for post-processed GNSS surveys which will be discussed in [Section IV](#) of this Chapter.

III. REAL-TIME KINEMATIC (RTK) GNSS SURVEYS

A. EQUIPMENT

A.1 GNSS Receivers

In addition to the requirements for Post-Processed GNSS Surveys, receivers to be used as Real-Time GNSS Rovers require a data transfer connection to receive GNSS correction data. This can be either an internal radio or cellular data connection.

A.2 GNSS Antennas

Most receivers designed to be used as GNSS rovers have integrated antennas. Nonetheless, a number of receiver and antenna combinations can be appropriately set up for Real-Time GNSS Surveys.

Antenna concerns for Real-Time GNSS Surveys are the same as those for Post-Processed GNSS Surveys.

A.3 Supplemental Equipment and Accessories

Conventional Base-Rover RTK Surveys require a radio or cellular modem to transmit GNSS correction data from the base to the rover. Radios will require an FCC license. A fixed height tripod is required for the base, and a tripod or other mount is required for the radio antenna. The rover will require a fixed height rod, and if setting control points or locating important features, a bipod or tripod. Rovers used for RTN survey require an Internet connection to receive correction data broadcast by the network servers.

A.4 Office Equipment and Accessories

Office review and data processing for smaller RTK surveys can often be done entirely in the data collector; however, a PC and appropriate software allow a greater depth of review and data processing and are recommended for all RTK surveys. Most major GNSS software allows both post-processing of real-time GNSS data and preparation of various reports.

B. GENERAL METHODS AND PROCEDURES

B.1 Real-Time Kinematic GNSS Survey Methods

Real-Time Kinematic GNSS Surveys can be performed using conventional Base-Rover Techniques or by using correction data provided by a Real-Time GNSS Network. Each method has unique factors which impact achievable survey accuracies and must be considered when determining their suitability for various survey projects.

Real-Time Kinematic GNSS Surveys are appropriate for use on projects where sufficient known control exists, and site conditions allow for reliable reception of broadcast correction data by the roving receiver.

Conventional Base-Rover Techniques are particularly useful for control densification and data collection on projects less than six square miles in size. With base lines less than three miles in length and appropriate redundancy, local 3D accuracies approaching those obtained by Total Station Survey methods can be accomplished. Larger projects can be done with a combination of conventional RTK and post-processed methods.

Real-Time Networks (RTN) are similar in concept to Conventional Base-Rover RTK Survey in that corrections sent from a base station improve rover positional precision in real time. The primary difference is that unlike RTK surveying, where the reference station is located at a known fixed position, RTN surveying uses

interpolated correction data based on the position of the rover relative to multiple reference stations.

A Real-Time Network consists of a permanent network of GNSS reference stations which continuously log data and stream it to a central server. The server stores the GNSS data in RINEX format, and performs quality assurance tests on the raw data, network modeling, and estimation of systematic errors, which allow calculation of correction data which is sent to the roving receiver via Internet connection. Such networks allow for survey by appropriately equipped rover receivers without the need to set up a conventional RTK base station.

A typical RTN survey involves visiting the site with a GNSS rover equipped with an Internet connection and appropriate data collection software. Ideally, the site is surrounded by the network base stations. Work can be performed around the perimeter of a network; however, the accuracy of modeled correction data will decrease as the rover travels further outside the network. The rover user will need to consider the possible impacts of this reduced accuracy when deciding how far outside the network they can work. The user sets up a survey project in the rover and logs into the RTN system via Internet.

The login process sends the position of the rover to the network server. The network server computes a “virtual reference station” in the vicinity of the rover, using input from the closest surrounding reference stations. Correction data is modeled at this virtual reference station and sent to the rover just as if a physical base were set up at the virtual base. If the rover travels a significant distance from the virtual base, a new virtual base is computed by the network. This ensures that corrections are based on short base lines.

As with any style of surveying, the accuracy of RTN surveying depends on many factors including the reference station distances, equipment and its settings, survey procedures, and the survey environment. Accuracy typically is in the range of, and in some cases can exceed, that of traditional RTK surveying.

Benefits of RTN surveying over traditional RTK surveying include:

1. No user-provided base station is required. This eliminates equipment expense and labor expense for initial site selection, base set-up, and issues of security, power supply, and the possibility of set-up errors.

2. Base line length-dependent error is reduced or eliminated because ionospheric, tropospheric, and orbital errors are interpolated at the site of the rover rather than assumed to be the same as those at the base. This enables centimeter level positioning at extended ranges from a reference station.
3. The network can be aligned with the National Spatial Reference System (NSRS) with high accuracy, ensuring that positional data will fit together over the entire network coverage area. The network can be set up to provide different formats and accuracies of correction data to a variety of users of geospatial data, including surveyors, GIS professionals, and emergency management personnel, with all users of the system using a common, established reference coordinate frame.
4. The RTN can be quality checked and monitored in relation to the NSRS and to detect if a problem occurs with an individual reference station.

Drawbacks and limitations include:

1. There is a high cost of setting up and maintaining the RTN and network subscription fees can be considerable.
2. Use of the RTN can be limited by wireless data access issues and system down times.
3. Interpolation issues may exist due to network spacing, communication, and error modelling methods. Work outside the network envelope may provide less accurate results than single base RT methods.
4. Network solutions may not fit local passive control, or the network datum may not be the same as the user's project datum. Sufficient checks to local passive control or individual project control are mandatory. If differences exist, a calibration or localization to this control may be required.

Currently all Real-Time GNSS Networks available in Illinois are operated by private vendors and require a fee subscription to use. Available networks include Trimble's VRSNow Illinois service, which offers coverage of the majority of the state with a network currently containing 39 reference stations, and Kara Company's ReIL-Net system, on which currently Kara streams RTK data from 32 CORS sites covering Illinois and Missouri. Information on Trimble's system is available at <https://www.trimble.com/positioning-services/vrs-now.aspx> and information on Kara's system is available at <https://www.karaco.com>.

Indiana, Iowa, Kentucky, Missouri, and Wisconsin all offer statewide Real-Time Networks administered by their respective Departments of Transportation. Subscriptions to these services are available free of charge by application to the appropriate state agency. These networks can often be utilized on projects in Illinois that are close to the state boundary.

B.2 Real-Time Kinematic GNSS Survey Procedures

There are a number of key points that apply to all RTK surveys, regardless of method or accuracy requirements. It is important to know the required accuracy for a survey and to design field procedures to obtain this accuracy. [Chapter 4](#) of this Manual specifies Accuracy Standards.

Reliable communication between the base and rover is essential. When using a conventional base, the broadcast radio antenna should be raised to the maximum height possible, and a fully charged 12-volt battery should be provided. RTN surveys are best conducted with a reliable cellular connection using a static IP address.

RTK survey requires redundancy of observations to verify survey accuracy. Redundancy is critical for control points or other important points. The rover must be initialized before collecting any data. Known points must be checked before, during, and after every surveying session. Control or other important points should be shot in the same initialization as check points. Multipath cannot be modelled with the short observation times used for RTK surveys and can induce vertical errors of over 20 cm.

RTK survey should not be performed during geomagnetic storms, passing of weather fronts, or if weather conditions are different at the base and rover. Adjust the base and rover circular level vial before every survey and check at regular intervals.

When using conventional base-rover RTK, the base must be placed in a location that has unobstructed sky visibility in all directions above a 10-degree elevation angle. It is better to establish a new control point in a wide open area than use a known point that is partially obstructed.

The Department has modeled the guidelines according to NGS's published User Guidelines for Single Base Real-Time GNSS Positioning ([V 2.1, August 2011](#)) which provided recommended best methods and background information intended to allow the user to obtain accurate, consistent three-dimensional positions using Single Base Real-Time GNSS techniques.

Listed below are data collection parameters to achieve various accuracies with a reliable confidence (95% level). These have been developed from years of best practices from the experiences of many RT users and also reflected in some existing guidelines (e.g., Caltrans, 2006). The rationale for publishing these guidelines without extensive controlled scientific testing is correlated to their use life and the needs of the user community. To run controlled experimentation with the plethora of variables associated with single base Real-Time positioning would take an inordinate amount of time and effort and would likely produce results that would be outdated by the time of their release. Additionally, the changing GNSS constellations and other new or improving technologies require a dynamic stance with these guidelines. New signals, frequencies, and satellite constellations will undoubtedly change the recommended procedures and accuracy classes that follow. Finally, the rapid growth of RTN stresses the need to port these single base guidelines to those for users of the networked solutions, rather than spend extensive time in research for single base applications.

Using newer GNSS hardware, firmware, and algorithms may produce the various accuracies over much longer baseline distances. Additionally, redundant positions at staggered times are showing a much closer positional comparison than previously seen. This may mean the Level 1 accuracies could be obtained using the criteria for Level 2, etc. Regardless of this, the user should at least be able to achieve the desired accuracy by using the appropriate criteria herein.

Level 1 Precisions: Typically 0.03-0.07 feet horizontal, 0.06-0.13 feet vertical (95% confidence), two or more redundant locations with a staggered time interval of two hours from different bases adjusted in the project control, each location differing from the average no more than the accuracy requirement. Discard outliers and re-observe if necessary. Base stations shall use fixed height tripods and be on opposite sides of the project, if possible. Base lines ≤ 6 miles. Data collected at a one-second interval for three minutes (180 epochs), PDOP ≤ 2.0 , ≥ 7 satellites, position solution RMS ≤ 0.03 feet. No multipath conditions observed. Rover range pole must be firmly set and leveled with a shaded bubble before taking data. Use fixed height rover pole with bipod or tripod for stability.

Level 2 Precisions: Typically 0.06-0.13 feet horizontal, 0.09-0.16 feet vertical (95% confidence), two or more redundant locations staggered at a two-hour interval, two different bases recommended, bases within the project envelope, each location differing from the average no more than the accuracy requirement. Discard outliers and re-observe if necessary. Base stations shall use fixed height tripods. Base lines ≤ 9 miles. Data collected at a five-second interval for one minute (12 epochs), PDOP ≤ 3.0 , ≥ 6 satellites, position solution RMS ≤ 0.05 feet. No multipath conditions observed. Rover range pole must be level before taking data. Use fixed height rover pole with bipod or tripod for stability.

Level 3 Precisions: Typically 0.13-0.19 feet horizontal, 0.13-0.26 feet vertical (95% confidence). Redundant locations not necessary for typical locations; important vertical features such as pipe inverts, structure inverts, bridge abutments, etc. should have elevations obtained from leveling or total station locations, but Real-Time horizontal locations are acceptable. Base lines ≤ 20 12 miles. Data collected at a one-second interval for 15 seconds (15 epochs) with a steady pole (enter attribute information before recording data). PDOP ≤ 4.0 , ≥ 5 satellites, position solution RMS ≤ 0.09 feet. Minimal multipath conditions. Okay to use Rover pole without bipod; try to keep pole steady and level during the location.

Level 4 Precisions: Typically 0.3-0.6 feet horizontal, 0.3-0.9 m vertical (95% confidence). Redundant locations not necessary for typical locations. Any base line length okay, as long as the solution is fixed. Data collected at a one-second interval for 10 seconds (10 epochs) with a steady pole, but okay to enter attributes as data is collected. PDOP ≤ 6.0 , ≥ 5 satellites, position solution RMS ≤ 0.16 feet. Any environmental conditions for data collection are acceptable with the previous conditions met. Rover pole without bipod okay.

With a base station considered as coordinate “truth,” the precisions of the observations taken at the rover reflect the accuracy to this truth. That is, the precision is the measure of local accuracy. If constraints have been applied to local passive monuments, it is important the base station be related to the localization performed. Therefore:

For Accuracy Levels 1 and 2:

If a localization has been performed, the base station must be inside the localization envelope and must be connected to the nearest localization control monument by a maximum of 1 cm + 1 ppm horizontal and 2 cm + 1 ppm vertical tolerances at the 95% confidence level.

For Accuracy Levels 3 and 4:

If a localization has been performed, the base station must be inside the localization envelope and should be connected to the nearest localization control monument at the accuracy level of the survey.

The following guidelines established both accuracy Levels and the data collection parameters intended to achieve the designated level of accuracy at a 95% confidence. Although developed for single-base positioning, the practices recommended by these guidelines are also applicable to Real-Time Network positioning.

ACCURACY LEVEL SUMMARY TABLE				
User Guidelines for Real-Time GNSS Positioning				
	Level 1	Level 2	Level 3	Level 4
ACCURACY (TO BASE)	0.05 FT HORIZONTAL 0.08 FT VERTICAL	0.08 FT HORIZONTAL 0.13 FT VERTICAL	0.16 FT HORIZONTAL 0.20 FT VERTICAL	0.49 FT HORIZONTAL, 0.82 FT VERTICAL
REDUNDANCY	≥2 LOCATIONS, 2-HOUR DIFFERENTIAL	≥2 LOCATIONS, 2-HOUR DIFFERENTIAL	NONE	NONE
BASE STATIONS	≥ 2, IN CALIBRATION PROJECT CONTROL	RECOMMEND 2 IN CALIBRATION	≥1, IN CALIBRATION	≥1, IN CALIBRATION RECOMMENDED
PDOP	≤ 2.0	≤ 3.0	≤ 4.0	≤ 6.0
RMS	≤0.03 FT	≤0.05FT	≤0.10 FT	≤0.16 FT
COLLECTION INTERVAL	1 SECOND FOR 3 MINUTES	5 SECONDS FOR 1 MINUTE	1 SECOND FOR 15 SECONDS	1 SECOND FOR 10 SECONDS
SATELLITES	≥7	≥6	≥5	≥5
BASE LINE DISTANCE	≤ 6.2 Miles	≤ 9.3 Miles	≤ 12.4 Miles	ANY WITH FIXED SOLUTION

B.3 Overview of Field Procedures

Awareness of sources of error and following a set of accepted field procedures will ensure that RTK surveys provide results that can be confidently shown to meet the intended survey accuracy.

In addition to the general procedures discussed in [Section III, B.2](#), field crews should be aware of the following:

- The more satellites and the lower the positional dilution of precision (PDOP), the better the results will be. Do not try to “force” use of RTK in inappropriate circumstances.
- The more redundancy, the better. Always observe important points multiple times and compare individual observations with the average of the results. Discard any outliers and re-observe the point until all observations fall within an acceptable range.
- Remember that RTK does not work well around tree canopy or tall buildings, and beware of sources of multipath.
- Beware of long initialization times. If initialization takes longer than normal, it may indicate issues with communication or ionospheric/tropospheric interference.

Perform a localization or site calibration to passive monuments, particularly for vertical surveys. Carefully review the residuals and other parameters, including the scale of the calibration and the slope of the correction surface to verify the validity of the calibration.

Be sure to record all pertinent metadata (data about data). This should include the source of the data and the datum; adjustment and epoch of the base station or network; field conditions including weather; serial numbers of all receivers, antennas and data collectors; details on receiver and collector firmware and software; discussion of redundancy, localizations, and checks; data file names; the date and time of the survey; and the names of all observers. Without this data the results of a RTK survey may amount to a file of coordinates of unknown value.

B.4 Overview of Office Procedures

Some basic office review should be performed on all RTK surveys, including checking of antenna heights, PDOP and RMS values, and consistency of redundant observations and checks. Results of localizations or calibrations should be double-checked, and all field data should be backed up and cataloged. Ensure that the results are consistent with the metadata logged in the field and meet project requirements, and a record of the review is stored in the project file.

Real-time surveys and the NGS guidelines will be discussed in greater detail in [Section V](#) of this Chapter.

IV. GNSS FOR CONTROL SURVEYS

A. INTRODUCTION

Both Post-Processed and Real-Time GNSS Techniques can be used for Control Surveys. The main factors to be considered when deciding which technique or combination of techniques to use are the size of the survey area, the density of control points to be established, the availability of existing record control of sufficient accuracy to control the new survey, and the desired accuracy of the new survey points.

The recent high-resolution geoid models and the increased density of high-quality GNSS observable bench marks being provided in Illinois by the Height Modernization Program have made GNSS survey a viable method of establishing vertical as well as horizontal control in much of the state. Control surveys of long corridors such as highways and railroads do offer unique challenges due to their geometry and the location of known record control relative to the project.

B. LARGE SCALE GEODETIC CONTROL SURVEYS

Large scale control networks such as District or County control networks tend to have individual control points or intervisible pairs of points placed at intervals of 2-5 miles. Control campaigns of this density are best suited for post-processed static GNSS surveys. The accuracy desired for such networks will be most likely achieved with static techniques, and the travel time between stations precludes the time savings and efficiency offered by real-time methods. Field procedures are simplified by not requiring real-time communication between receivers, and a simpler multi-receiver work flow can be maintained.

C. GUIDELINES FOR POST-PROCESSED GNSS CONTROL SURVEYS

The primary guidelines for performing Post-Processed GNSS Control Surveys are contained in the Federal Geodetic Control Committee's "[Geometric Geodetic Accuracy Standards and Specifications for Using GPS Relative Positioning Techniques](#)," published May 11, 1988.

This publication establishes minimum accuracies for six classifications or orders of surveys using a distance accuracy standard, which is the ratio of the relative positional error of a pair of points to the horizontal distance between these points. This publication also summarizes recommended field and office procedures for GNSS surveys. It is somewhat dated, but is still an excellent overall guide for post-processed GNSS control surveying.

NGS has more recently developed [Guidelines for Establishing GPS-Derived Orthometric Heights](#), published as NOAA Technical Memorandum NOS NGS 59, which are designed to achieve orthometric height network accuracies of 2 cm and orthometric height local accuracies of 2 cm to 5 cm. The 3-4-5 System developed in this memorandum is summarized below and provides excellent guidance for post-processed control surveys in general, and is considered mandatory for GNSS vertical control surveying. The 3-4-5 System uses three basic rules, four control suggestions, and five procedures necessary for estimating GNSS-derived orthometric heights.

Three Basic Rules:

Rule 1: Follow NGS' guidelines for establishing GNSS-derived ellipsoid heights for the desired accuracy of orthometric heights (2 cm or 5 cm).

Rule 2: Use NGS' latest national hybrid geoid model, currently GEOID12A, when computing GNSS-derived orthometric heights.

Rule 3: Use NAVD 88 height values to control the project's adjusted orthometric heights.

Four Basic Control Requirements:

1: Occupy stations with valid NAVD 88 orthometric heights, evenly distributed throughout the project. Stations with previously determined GPS-derived Helmert orthometric heights accurate to 2 cm and published in the NGS database are considered valid NAVD 88 stations, as well as stations with published NAVD 88 heights established by differential leveling. Occupations shall be for the recommended duration, on different days and during periods of significantly different satellite geometry.

2: For projects less than 20 km on a side, surround the project with a minimum of four NAVD 88 stations, one in each corner of the project. This may require enlarging the project area beyond the original area of interest.

3: For project areas greater than 20 km on a side, keep distances between valid occupied NAVD 88 bench marks to less than 20 km. When possible include extra NAVD 88 bench marks as checks.

4: Projects in mountainous regions should include occupations of valid bench marks at the highest and lowest elevation in the area. This is not particularly relevant in most of Illinois but worthy of consideration when working in areas of significant relief.

Five Basic Procedures:

Procedure 1: Perform a 3D minimum constrained least squares adjustment of Helmert orthometric heights for the project; i.e., constrain the latitude and longitude of one NSRS control station and one NAVD 88 orthometric height value.

Procedure 2: Detect and remove all outliers from the Procedure 1 adjustment. If needed, observe additional base lines and repeat Procedures 1 and 2 until all outliers are removed.

Procedure 3: Compute the differences between the results of the minimum constrained adjustment (using the latest national geoid model) and published NAVD 88 orthometric heights.

Procedure 4: Based on results of Procedure 3, determine which NAVD 88 control stations have small enough residuals to be considered valid for inclusion in the final constrained adjustment.

Procedure 5: Using the results from Procedure 4, perform a constrained orthometric height adjustment by fixing all valid NAVD 88 heights. As a check on the influence of the additional constraints, the results of the Procedure 5 and Procedure 2 adjustments should be compared.

If differences exceed 2 cm, it is possible that an invalid NAVD 88 value was held fixed, or that there are discrepancies in the local control.

D. LONG CORRIDOR CONTROL SURVEYS

Long Corridor Control Surveys are generally performed to provide control for photogrammetric, design, and cadastral surveys along routes. The long narrow configuration of such a survey provides unique challenges, particularly when sufficient record vertical control does not surround the project. Projects far removed from NGS level lines will require a static GNSS survey, as discussed above, or even possibly differential leveling to establish sufficient vertical control to allow densification by fast-static, kinematic, or real-time methods.

E. LOCAL CONTROL SURVEYS

Local Control Surveys are those which are performed for control densification for design or cadastral surveys on projects under 10 miles on a side, where primary horizontal and vertical control has been established by a larger area survey. Post-Processed Fast Static and/or Real-Time GNSS Survey techniques (Level 1 and Level 2 per [Summary Table](#) (discussed in [Section III](#)) are appropriate for such surveys.

Appendices from NOS NGS 59 are included as [Appendices](#) to this Chapter. Department staff and Consultants performing GNSS control surveys for the Department are strongly encouraged to study the full publications and incorporate the specified procedures in their surveys.

V. GNSS FOR DATA COLLECTION AND STAKING SURVEYS

A. INTRODUCTION

The majority of GNSS data collection surveys will use Real-Time (RT) methods, although there are some circumstances where post-processed kinematic methods are appropriate, such as continuous data collection from a vehicle or boat.

This section will discuss the specifications for RT surveys and the data collection procedures necessary to obtain results meeting various accuracies at a high level of confidence. These procedures have been developed by the Department from practical experiences of RT users and NGS guidelines “User Guidelines for Single Base Real Time GNSS Positioning” ([V 2.1, August 2011](#)).

Empirical evidence has shown that with improvements in GNSS hardware and firmware, various accuracies may be obtained without rigorous adherence to all aspects of these specifications. It is the responsibility of the individual user to ensure that they can demonstrate that the methods used on a specific project meet the required accuracy.

Accuracy of GNSS measurements can only be verified by a combination of analysis of redundant measurements of individual points and comparison of measured values with published values of NGS, or other existing control points of known accuracy. Higher accuracy classes require a localization or calibration to existing known control. All classes require checks to existing project control points. Review of the NGS Accuracy Class Summary Table (NGS’ User Guidelines, V 2.1) shows that as accuracy requirements increase, the requirements for redundancy, control checks, and calibrations increase along with requirements for satellite geometry, base line distance, and observation time.

Proper GNSS data collection practice requires that check shots be taken before, during, and after the data collection session. Higher accuracy classes require checks to be taken at different times of day to ensure use of different satellite configurations. Control points surrounding the survey area shall be selected to demonstrate that accuracy is consistent throughout the survey.

Redundant measurements on survey points shall be compared to the average of all observations. Individual observations that deviate from the average by more than the project accuracy should be re-observed. Inability to obtain redundant measurements within the specified accuracy is an indication the methods being used are not appropriate for the desired survey accuracy.

Checks to NGS or other known control allow for analysis of how the survey fits with the NSRS and local project control. Most RTNs are well aligned with the NSRS as far as horizontal position; however, the CORS or other base stations used in the network may not be tied to an orthometric height. All vertical RT surveys require checks to local vertical control.

The following blunder detection technique should be used by the rover operator when observing check points or other important points:

- After observing the point, step away from the point and invert the rover for a few seconds to force it to lose initialization. Re-initialize and take another shot on the point. The second shot can be a 5 epoch shot.
- Compare the two results and verify that they do not grossly differ. In case of gross difference, re-initialize and repeat the pair of shots.

Checks to NGS or other known control also provide the basis for a localization or site calibration. Levels 1, 2, and 3 surveys (and any survey requiring accurate elevations) all require a calibration be performed. While RTN surveys may only require a vertical calibration, conventional base-rover surveys will generally require both a horizontal and vertical calibration to determine both network accuracy relative to the NSRS and local vertical accuracy.

A vertical calibration requires a minimum of four NAVD 88 orthometric height bench marks be observed, and the GNSS rover should be configured to use the latest hybrid geoid model. These bench marks should form a rectangle around the project area. If this is not possible they must be as widely distributed as possible, in as many quadrants as possible, and as close to the project perimeter as possible. Additional bench marks within the project area should be included as checks on the calibration results and can be fixed in the calibration if appropriate. As previously discussed, static GNSS survey or differential leveling may be required to establish control to use in a calibration prior to RT survey.

A horizontal calibration requires a minimum of three known horizontal control points and one NAVD 88 bench mark. In areas with sparse NGS control, OPUS offers a good method to establish NSRS values on a RTK base or other horizontal calibration points.

The results of the site calibration, including residuals, scale, and slope of the inclined plane computed by a vertical calibration, must be carefully analyzed before accepting and applying to the collected data. Residuals exceeding the survey accuracy determined by analysis of redundant observations, a scale factor significantly different than 1.0 or excessive slope of the inclined plane may indicate inconsistencies in the record control. If so, additional record control points may need to be added, or the record control may need to be verified by static GNSS or differential leveling.

Results of all control checks, comparison of redundant observations, and results of localizations or calibrations shall be included in the Project Report.

B. DESIGN AND CONSTRUCTION SURVEYS

Design and Construction surveys require accurate elevations. Level 2 and 3 RT surveys can often provide the requisite vertical accuracy, but this can only be confirmed by checks to local passive monuments related to the design vertical datum and calibrations as discussed above. Redundant measurements and calibration results must be carefully analyzed to determine if RT methods meet project requirements. Critical elevations, such as those on pavements, bridges, and drainage structures, may require conventional total station or differential level survey to obtain required project vertical accuracy. While RT GNSS can meet the accuracy requirements for general grading and construction staking, the Department does not allow the use of GNSS for staking of pavement grades or as-built survey for pavement and other like improvements.

C. CADASTRAL SURVEYS

Cadastral surveys requiring only horizontal locations can generally be accomplished with Class Level 2 and in some cases Level 3 methods, providing objects to be surveyed are located in GNSS-friendly environments. Surveys in wooded areas or near obstructions such as buildings and other property improvements may require conventional total station survey to achieve the required horizontal accuracy for a boundary survey. Control points set for such conventional survey should be established using a minimum of Level 2 methods.

When the cadastral survey is being performed for land acquisition on a design project it is mandatory that control points from the design survey are checked in the cadastral survey. A localization or calibration can be performed if needed to fit the design survey control.

Analysis of redundant measurements on horizontal check points is required to demonstrate achieved accuracy. Results of this analysis and of any localizations or calibrations are to be included in the Project Report.

D. PHOTO CONTROL AND LIDAR CHECKPOINT SURVEYS

Depending on mapping accuracy requirements, control for aerial mapping surveys can often be established using Levels 1, 2, or 3 methods. Level 1 and 2 methods shall be used to support the large-scale photogrammetric mapping surveys. This includes both aerial targeting control and any post-marked photo control identities.

The Department prefers that Levels 1 or 2 be utilized to support both small-scale photogrammetric mapping where Airborne GPS is considered the primary control in support of the mapping efforts and checkpoint surveys supporting both LiDAR and aerial mapping. However, Level 3 methods could be utilized where the density of points to be surveyed or the location of selected points do not lend themselves to multiple base stations since the surveying efforts were only to validate the mapping effort and not as the primary support.

As with all RT surveys, specific project accuracy requirements will need to be considered when choosing the appropriate method, and analysis of control checks and redundant measurements will need to be performed to verify the specific accuracy is being met.

VI. REFERENCES

Hull, Wesley V., Rear Admiral, Federal Geodetic Control Committee, 1988, Geometric Geodetic Accuracy Standards and Specifications for Using GPS Relative Positioning Techniques, Federal Geodetic Control Committee.

http://www.ngs.noaa.gov/FGCS/tech_pub/1984-stds-specs-geodetic-control-networks.htm

Henning, W., NGS, 2010, NGS User Guidelines for Single Base Real-Time Positioning, National Geodetic Survey.

http://www.ngs.noaa.gov/PUBS_LIB/NGSRealTimeUserGuidelines.v.1.1.pdf

Henning, W., et al., NGS, 2011, NGS Guidelines for Real-Time GNSS Networks, National Geodetic Survey.

http://www.ngs.noaa.gov/PUBS_LIB/NGS.RTN.Public.v.2.0.pdf

Zilkoski, D.B., Carlson, E.E., & Smith, C., March 26, 2008, Guidelines for Establishing GPS-Derived Orthometric Heights (Standards: 2 cm and 5 cm) NOAA TM NOS NGS-59.

http://www.ngs.noaa.gov/PUBS_LIB/NGS592008069FINAL.2.pdf

VII. APPENDICES

A. DEFINITIONS

NSRS Stations (~75 km spacing):

High accuracy NAD83 three-dimensional stations (CORS, FBN, HARN stations) surrounding the project area in a minimum of three different quadrants. Stations assist in providing the network accuracy, and they may be newly established stations in the survey project, if specifications and procedures are used to establish them. These procedures are not covered in this document.

Primary Base Stations (~40 km spacing):

Evenly distributed stations surrounding the local survey. These stations relate the local network to NSRS to the 5 cm, or better, standard through simultaneous observations with NSRS control stations. They may be newly established stations, and they may be part of the local network.

Secondary Base Stations (~15 km):

Stations are evenly distributed throughout the local network to ensure the local network does not contain a significant medium wavelength (20-30 km) ellipsoid height error through simultaneous observations with primary base stations. These stations may be newly established stations and are part of the local network. They are located between Primary Base Stations.

Local Network Stations (<10 km):

Stations that are not primary or secondary base stations, but are part of the local network. They provide the local accuracy standard through simultaneous observations between adjacent stations.

B. GPS ELLIPSOID HEIGHT HIERARCHY AND BASIC GUIDELINES

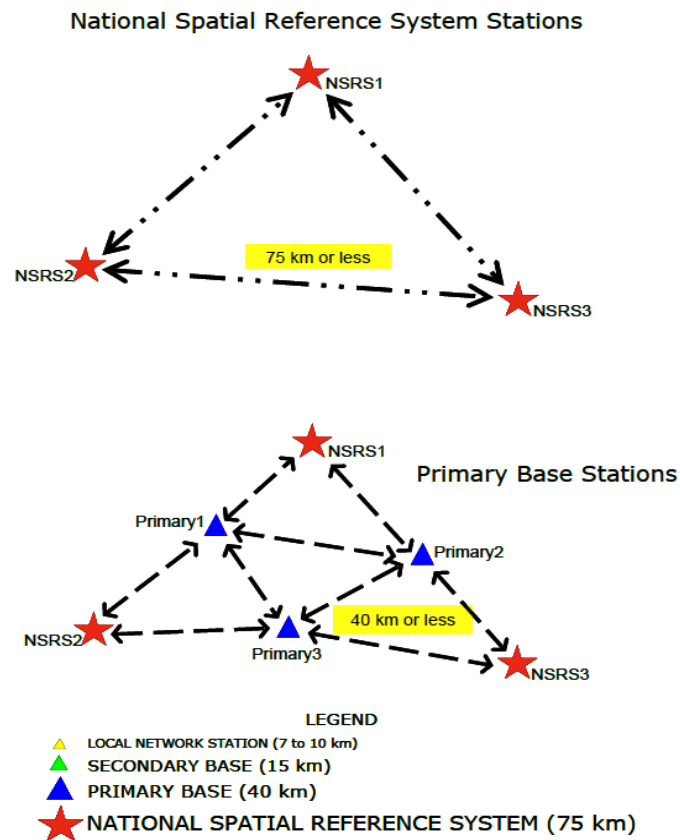

Basic Guidelines for Establishing Primary Base Stations:

- 5-hour sessions for three days
- Spacing between primary base stations should not exceed 40 km
- Each primary base station should have observational vectors connecting it to at least its nearest primary base station neighbor and nearest NSRS control station. Primary base stations should be traceable back to two NSRS control stations along completely independent paths; i.e., base lines Primary1-NSRS1 and Primary1-NSRS2, or Primary1-Primary2 plus Primary2-NSRS3.

Secondary Base Stations

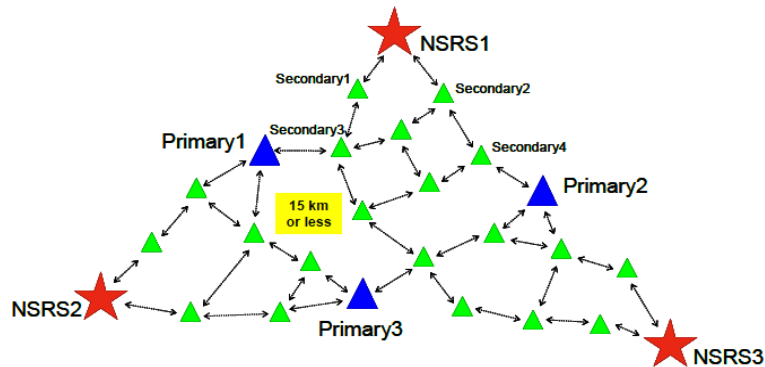

LEGEND

- ▲ LOCAL NETWORK STATION (7 to 10 km)
- ▲ SECONDARY BASE (15 km)
- ▲ PRIMARY BASE (40 km)
- ★ NATIONAL SPATIAL REFERENCE SYSTEM (75 km)



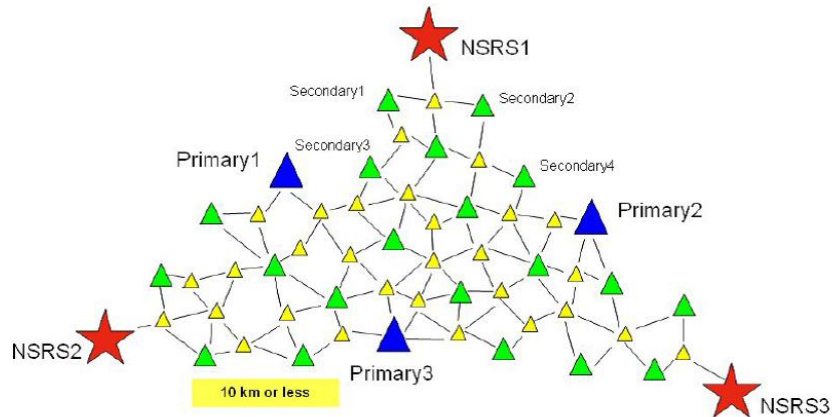

Basic Guidelines for Establishing Secondary Base Stations:

- 30-minute sessions / 2 days / significantly different satellite geometry. (Note: 30-minute sessions should be the minimum. In some locations, due to abnormal atmospheric conditions, poor satellite geometry, and local multipath effects, it may be necessary to collect more than 30 minutes of data to meet the 2 cm repeat base line requirement.)
- Spacing between secondary base stations (or between primary and secondary base stations) should not exceed 15 km.
- All base stations (primary and secondary) must be connected to at least the two nearest primary or secondary base station neighbors.
- Secondary base stations should be traceable back to two primary or NSRS base stations along independent paths; i.e., Secondary1-NSRS1 and Secondary1-Secondary3 plus Secondary3-Primary1.
- Secondary base stations need not be established in “small” area surveys.

Local Network Stations



LEGEND

-  LOCAL NETWORK STATION (7 to 10 km)
-  SECONDARY BASE (15 km)
-  PRIMARY BASE (40 km)
-  NATIONAL SPATIAL REFERENCE SYSTEM (75 km)

Basic Guidelines for Establishing Local Network Stations:

- 30-minute sessions / 2 days / significantly different satellite geometry. (Note: 30-minute sessions should be the minimum. In some locations, due to abnormal atmospheric conditions, poor satellite geometry and local multipath effects, it may be necessary to collect more than 30 minutes of data to meet the 2 cm repeat base line requirement.)
- Spacing between local network stations (or between base stations and local network stations) should not exceed 10 km.
- All local network stations should be connected to at least its two nearest neighbors.
- Local network stations should be traceable back to two primary base stations along independent paths.

CHAPTER FOUR
ACCURACY STANDARDS

BUREAU OF DESIGN AND ENVIRONMENT
SURVEY MANUAL

May 2015

CHAPTER FOUR
ACCURACY STANDARDS

Table of Contents

	Page
I. INTRODUCTION.....	4-1
II. ACCURACY AND PRECISION.....	4-2
III. RELATIVE POSITIONAL ACCURACY STANDARDS.....	4-2
A. Relative Positional Accuracy	4-2
B. Data Categories.....	4-3
C. Error Propagation	4-3
IV. STANDARDS AND SPECIFICATIONS.....	4-4
A. Project Control.....	4-4
B. Design Surveys	4-5
C. Right-of-Way Surveys.....	4-6
D. Hydrographic Surveys	4-7
E. Construction Surveys	4-8
V. DATUM	4-8
A. National Spatial Reference System.....	4-8
B. Illinois State Plane Coordinate System	4-8
C. Vertical Datum.....	4-9
VI. ACCURACY TESTING	4-10
A. Least Squares Adjustment.....	4-10
B. Root Mean Square Error.....	4-10
C. RMSE Reporting.....	4-11
VII. REPORTING AND DELIVERABLES.....	4-12
A. Survey Report	4-12
VIII. SURVEY STATISTICS	4-13
A. General Statistics	4-13
B. Geospatial Positioning Accuracy Standards.....	4-15
C. Relative Closure Ratio Accuracy.....	4-15

CHAPTER FOUR

ACCURACY STANDARDS

I. INTRODUCTION

The Illinois Department of Transportation has adopted accuracy standards to be used for the various types of surveys that are required to produce the plans, plats, maps, and drawings required to support the activities of the Department. Accuracy as a separate Chapter is a completely new addition to the Survey Manual. The previous Manual addressed accuracy specifically to closure. However, this new Chapter addresses accuracy as the basis for all professional services provided and its connection to the surveying standard of practice.

A Standard, as used in surveying, is a minimum or maximum value or range of acceptable units of measure obtained by a set of specifications used to obtain the value. Specifications are the minimum operations or procedures required to meet a specific standard, often referred to as Performance Based Specifications. Performance specifications focus more on the results to be achieved and less on the methods of accomplishing the results.

The standards will help to ensure uniformity and allow the survey professional to know what results are expected of the various services that are to be performed. The surveying industry is dramatically changing at ever-increasing rates. The equipment and procedures available at the writing of this Manual will be outdated in the very near future. Therefore, the Department prefers to only establish accuracy standards that will meet the needs of the program instead of dictating procedures and equipment to accomplish those standards. The procedures and specifications outlined in this and subsequent Chapters are guidelines that will allow the user to meet the standards based on today's technology.

It is entirely at the discretion of those professionals working for the Department to select the procedure, methodology, and instrumentation that will meet the standards. While this discretion allows a great degree of freedom to the professional, it also requires that rigorous testing and reporting will be required to ensure the standards have been met.

II. ACCURACY AND PRECISION

Accuracy relates to the quality of the result obtained when compared to the standard. Accuracy is defined as the degree of conformity with a standard or a measure of closeness to a true value.

Precision is the degree of refinement in the performance of an operation (procedures and instrumentation) or in the statement of a result. The term precise also is applied, by custom, to methods and equipment used in attaining results of a high order of accuracy, such as using three-wire leveling methods or a one-second theodolite. The more precise the survey method, the higher the probability that the survey results can be repeated.

Survey observations can have a high rate of precision, but be inaccurate; for example, observing with a poorly adjusted instrument. Precision can also indicate the number of decimal places to which a computation is carried and a result stated. However, calculations are not necessarily made more precise by the use of tables or factors of more decimal places. The actual precision is governed by the accuracy of the source data and the number of significant figures, rather than by the number of decimal places.

Accuracy should not be confused with precision, which relates to the characteristics of the procedure or operation used to obtain the result. Often accuracy is more simply described as the minimum quality necessary to meet a specific objective.

III. RELATIVE POSITIONAL ACCURACY STANDARDS

A. RELATIVE POSITIONAL ACCURACY

Today, survey standards use a concept of Relative Positional Accuracy as opposed to the classical Error of Closure such as 1:50,000. Current standards throughout the nation use positional accuracy standards for predesign surveys, property surveys, topographic surveys, and construction surveys. When providing geodetic point coordinate data, a statement can be provided that the data meets a particular accuracy standard for both the local accuracy and the network accuracy. For example, geodetic control data may meet the 2-cm local accuracy standard for the horizontal coordinate values and the 5-cm local accuracy standard for the vertical coordinate values (heights) at the 95% confidence level, while meeting a network positional accuracy of a different value.

For the purpose of the Department's Standards, Relative Positional Accuracy is a value that represents the uncertainty of the location of any point in the survey relative to any other point in the same survey at the 95% confidence level.

B. DATA CATEGORIES

The following table depicts groups of data arranged by categories and is based on the Department's Point Code format for collection of various topographic features. The Relative Positional Accuracy Standards shown for each feature represent the plus or minus tolerance of the feature. The Relative Positional Accuracy Standard of the feature should be expressed as the feature position compared to another feature in the same survey based on test results at the 95% confidence level (2 sigma).

C. ERROR PROPAGATION

It is common standard of practice to record survey measurements in specific units of measure to a prescribed significant figure. Elevations for hard surface features are recorded to the nearest 0.01 foot. Elevations for ground surfaces are recorded to the nearest 0.1 foot. Distance measurements are recorded to the nearest 0.01 foot when measuring control and boundary features, as well as other important topographic features. The Positional Accuracy and the Tolerance levels shown in Table 4.1 do not imply those standards of care are to be relaxed.

On the contrary, they represent realistic values for accuracy of measurements that take all errors into account. All surveys performed by or for the Department should have all survey errors accounted for as is reasonably possible. Common survey errors include pointing, reading, instrument centering, target centering, distance measurement, etc. Least squares adjustments routines and typical real-time collection devices account for these combined errors.

Category	Northing +/- ft.	Easting +/- ft.	Elevation +/- ft.	Relative Local Positional Accuracy
Control, Horizontal	0.04	0.04	NA	0.08
Control, Vertical	NA	NA	0.04	0.08
Boundaries	0.04	0.04	NA	0.08
Alignments	0.04	0.04	NA	0.08
Pavement Features	0.08	0.08	0.04	0.16/0.08
Shoulders, Medians, C&G	0.08	0.08	0.04	0.16/0.08
Aboveground Utilities	0.4	0.4	0.1	0.8/0.2

TABLE 4.1 – Accuracy Value Reported at 95% Confidence (continued)				
Category	Northing +/- ft.	Easting +/- ft.	Elevation +/- ft.	Relative Local Positional Accuracy
Traffic Signals	0.4	0.4	NA	0.8
Sidewalks & Driveways	0.08	0.08	0.04	0.16/0.08
Drainage	0.4	0.4	0.1	0.8/0.2
Buildings, Fences & Mailboxes	0.4	0.4	NA	0.16
Bridges, Structural	0.04	0.04	0.04	0.08/0.08
Bridges, Topographic	0.08	0.08	0.04	0.16/0.08
Railroad Features, Rails	0.08	0.08	0.04	0.16/0.08
Railroad Features	0.4	0.4	0.1	0.8/0.2
Underground Utilities	0.8	0.8	NA	1.6
Vegetation Features	0.8	0.8	0.1	1.6/0.2
Water Features	0.8	0.8	0.1	1.6/0.2
Profiles, Hard Surface	0.4	0.4	0.04	0.8/0.08
Profiles, Ground	0.4	0.4	0.1	0.8/0.2
Cross Sections, Hard Surface	0.4	0.4	0.04	0.8/0.08
Cross Sections, Ground	0.4	0.4	0.1	0.8/0.2
Hydrographic Soundings	1.4	1.4	0.4	2.8/0.8

IV. STANDARDS AND SPECIFICATIONS

A. PROJECT CONTROL

All horizontal project control should be based on the National Spatial Reference System (NSRS). A minimum of three (3) existing NGS control stations should be used from which to base the proposed project control. The Department may, at its discretion, allow the use of only two (2) existing control stations. Regardless of the method of survey, GPS or otherwise, all project control shall be set to a Relative Positional Accuracy Standard as outlined in [Table 4.1](#).

All control established by GPS shall be surveyed using 100% redundancy and a network of closed loop(s). Real-Time Kinematic (RTK) shall not be used to establish project control. Control established by conventional optical survey equipment shall be in the form of a closed traverse(s). A rigorous least squares adjustment shall be made for all control points. At a minimum, both a minimally constrained adjustment to help eliminate blunders and errors and a fully constrained adjustment holding the existing NGS control stations fixed shall be made and the results included in the Project Survey Report.

All vertical project control shall commence on an existing NGS bench mark and close on a second existing NGS bench mark. On small projects, the Department may at its discretion allow only one bench mark to be used. All vertical project control shall be set to a Relative Local Positional Accuracy, as outlined in [Table 4.1](#). A minimum of two (2) project bench marks shall be set along the project limits. Spacing shall be as determined by the Department, but shall not exceed a maximum of 5,300 feet. All vertical control set in a network configuration shall be adjusted by least squares adjustment. Simple linear level loops along a corridor may be adjusted by other acceptable error propagation techniques. Linear level loops along a corridor, such as lines run on each side of a highway where forward and backward level runs are separated by a short distance (less than 500 feet), cross ties will be required to properly adjust the level lines using least squares adjustment.

B. DESIGN SURVEYS

Design Surveys for the Department are those surveys required to collect existing topographic features and elevations to prepare maps and drawings depicting those features and elevations. A separate Chapter is devoted to the discussion of Design Surveys ([Chapter Five](#)). This section addresses the Accuracy Standards anticipated by the Department while performing Design Surveys.

Design surveys can be collected by a wide variety of methods, including direct measurements and remote sensing techniques. In the past, most topography was collected by a station offset procedure where the station along a base line was measured and the offset from the same base line was measured at approximate right angles to the base line. This method is still a valid survey technique if the survey can be accomplished to the standards set forth. This method has long been replaced by use of modern survey techniques including total stations, GPS, and terrestrial-based LiDAR (Light Detection and Ranging, also laser scanning). In addition, many larger projects are mapped by traditional aerial photography and/or aerial LiDAR. Regardless of the technique employed by existing technology, or even technology that may not yet exist, the Department has set forth accuracy standards that are important for the Department to meet the needs of designs based on those surveys.

Regardless of the survey technique employed, it is reasonable to expect a certain accuracy for a specific feature. If it is not possible to obtain the level of accuracy required for that feature by a certain survey technique, then an alternate technique should be employed. As an example, if aerial surveying is selected to collect design survey information and the project area contains pavement where vertical accuracies cannot be met by aerial mapping, then an alternate survey technique must be used to collect the pavement elevations.

Feature categories and their required Positional Accuracy Standards are listed in [Section III](#) above, [Table 4.1](#).

C. RIGHT-OF-WAY SURVEYS

Right-of-way surveys include those surveys performed in support of Land Acquisition surveys for the preparation of plats and plans. There is a separate manual that addresses [Land Acquisition Policies and Procedures](#). However, that manual does not set forth standards or specifications with respect to measurement “accuracy standards” that a professional surveyor must achieve to meet the needs of the Department. Likewise, the State of Illinois Minimum Standards for performing boundary surveys details many requirements the Professional Surveyor must meet, but also does not dictate a set of accuracy standards that a professional must know in advance in order to properly plan and execute a survey. In Illinois, at present, the only standard that requires Professional Surveyors to perform to a specific accuracy standard is the [2011 ALTA/ACSM Land Title Survey Standards](#).

This standard currently requires all surveys to be performed to a “relative positional precision of 0.07 foot plus 50 PPM.” The new ALTA Standard specifies “Relative Positional Precision” as “the length of the semi-major axis, expressed in feet or meters, of the error ellipse representing the uncertainty due to random errors in measurements in the location of the monument, or witness, marking any corner of the surveyed property relative to the monument, or witness, marking any other corner of the surveyed property at the 95% confidence level (two standard deviations). Relative Positional Precision is estimated by the results of a correctly weighted least squares adjustment of the survey.” Based on its definition, Relative Positional Precision can be considered the same as defined in the Relative Positional Accuracy Standards in [Section III](#) above.

D. HYDROGRAPHIC SURVEYS

Hydrographic surveys include surveys performed in a body of water to collect topographic features. Drainage surveys are considered part of a topographic survey, and while hydrographic surveys may be a part of a drainage survey, hydrographic surveys may be performed independent of a drainage survey. Drainage surveys are more fully discussed in the Department's [Drainage Manual](#).

Hydrographic surveys performed in any body of water face similar challenges. There are a variety of methods available to accomplish the required results. Those survey methodologies are more fully discussed in [Chapter Nine](#) of this Manual. This section details the accuracy standards expected from the results of those surveys.

Hydrographic surveys can be collected by conventional surveying techniques which include a leveling rod, a prism pole using a total station, or a fixed pole using GPS rover during RTK surveys. The primary limitation to conventional surveys is water depth and bottom material. Water depths exceeding eight (8) feet are exceedingly difficult to measure based on wind, current, and access. While the use of rods and poles (referred to as sounding poles) is not necessarily the only conventional technique that can be employed, it is the primary conventional method. The use of lead lines, which allows measurements to be made in deeper water, is an alternate conventional survey technique where elevation of the bottom is based on water depth. This method requires an alternate means of positioning as well as a more accurate means of water level determination such as portable stilling wells or gauge stations.

Bottom material is an important consideration in hydrographic surveys and sounding poles should be fitted with suitable plates to meet the project needs. Bottom materials can range from hard packed to fluff, where the actual bottom is very difficult to determine.

The primary method of performing hydrographic surveys today is the use of remote sensing equipment such as "echosounders." Echosounders are a form of Sonar (originally an acronym for Sound Navigation and Ranging), a technique that uses sound propagation to measure water depths. The use of echosounders is a complex technique that should only be performed by those trained and experienced in the many intricacies of the process to ensure adequate results are obtained. Echosounders are available from many manufacturers using a variety of technologies but all are based on sound propagation through a water column. There are single beam echosounders (SBE), multi beam echosounders (MBE), and even arrays of the combined units.

The many variables present in hydrographic surveys include water quality to determine the speed of sound in the water column; bottom material to determine where the bottom is; echosounder frequency appropriately chosen for the conditions; positioning of the reference point on the vessel; and, most importantly, heave, pitch, and roll compensation to correct for slope measurement as the vessel moves during data collection. These factors require a separate and distinct set of standards with respect to position and depth. (See [Table 4.1](#)).

E. CONSTRUCTION SURVEYS

Construction surveys vary on a project-by-project basis in regard to what is required of the Department. Some projects may require the Department to furnish all construction staking for the contractor, while others may only be to check the contractor's staking. In addition, the use of machine control construction with GPS-controlled equipment is quickly advancing and will eventually be the norm rather than the exception.

Regardless of what the construction circumstance is, project control is the responsibility of the Department. Project control should be recovered from the original survey where possible.

Additional control that must be set to augment the original project control should follow the same standards that were used on the original survey. Base station(s) set for machine control should follow the same standards required of the original project control. Staking of individual components of the construction may follow standards appropriate for the pay item being staked.

V. DATUM

A. NATIONAL SPATIAL REFERENCE SYSTEM

The National Spatial Reference System (NSRS) is more fully discussed in [Chapter Two](#). It provides the Department the opportunity to reference all of its projects statewide to a uniform well-adopted precise framework.

B. ILLINOIS STATE PLANE COORDINATE SYSTEM

At present the Department has adopted the Illinois State Plane Coordinate system as the reference framework for all surveys performed by or for the Department. The Illinois State Plane Coordinate System is likewise more fully discussed in [Chapter Two](#).

However, the Department has adopted certain procedures that impact the use of state plane coordinates that are more fully discussed here.

On a project basis, as directed by the Chief of Surveys, projects will require that horizontal control shall be established along the project limits, preferably outside of future construction limits. A series of primary control stations should be set. These stations will be monumented with semi-permanent monuments as approved by the Department. The monument type and spacing shall be determined by the Department on a project-by-project basis.

It is a common practice at the Department to perform project aerial mapping on the state plane grid. Even projects that are small and will not be mapped by aerial mapping will require that control brought to the project start from State Plane Control Stations. Regardless of the instrumentation used to establish project control, whether GPS or classical optical instrumentation, a thorough understanding of State Plane Coordinates is required to properly perform the work.

All surveys performed for or by the Department will be established in the appropriate State Plane Zone, as determined by the Chief of Surveys. The survey control and data points collected in the process of the survey shall be computed as State Plane Grid coordinates by applying an appropriate combination factor as directed by the Department. Data may be delivered in State Plane Grid or as ground coordinates at the sole discretion of the Department.

C. VERTICAL DATUM

The Department has adopted the North American Vertical Datum of 1988 (NAVD88) as the vertical reference framework for all projects performed by or at the request of the Department.

At the writing of this Manual, Illinois is currently in the process of performing a comprehensive Height Modernization Program (HMP) throughout Illinois. These bench marks are stable, high-quality marks that should be incorporated into any vertical project control campaign when reasonably proximate to the project. The Department will dictate during the scope meeting for a project when the HMP bench marks should be used.

Project bench marks shall be permanent in nature. Iron rods driven in the ground are not acceptable bench marks. The Department will approve bench mark type and spacing at the scope meeting.

VI. ACCURACY TESTING

A. LEAST SQUARES ADJUSTMENT

Accuracy testing is required for both project control and where data points are collected from a single point reference, in other words, from a side shot during a total station survey or from GPS during an RTK campaign, regardless if it is a local base or an RTN. When project control is established it should be adjusted by least squares and have sufficient redundancy to report statistical analysis of the survey. No primary control should be established by a side shot (radial survey) regardless of the current technology being used.

B. ROOT MEAN SQUARE ERROR (RMSE)

When single point data is collected radially from a single control point, it too needs to be tested. Generally, statistical testing requires analysis of a sample population based on certain hypothesis of the general population. Thus when the population is considered infinite, you may assume certain conditions to be true when testing. Given that survey data (raw data) is not infinite, but its errors should still follow the normal distribution, the sample population (test data) statistics can be determined by the standard error. The Root Mean Square Error (RMSE) should be used to evaluate test data taken from a population of radial surveyed data points. Classical statistics state that it is generally an accepted practice to predetermine the number of data points in a test population. However, the Department has set minimum test criteria based on the size of the project in the interest of keeping testing to a minimum. Accuracy testing should be made on a minimum of thirty (30) data points per category. In other words, whether there are 100 underground utility features (categories) collected or 500, there should still be only 30 underground utility features tested by a redundant measurement in addition to 30 each for each of the feature categories in the project. Obviously if any feature category occurs less than 30 times on the entire project, then it is only necessary to test a smaller number. At least two (2) features and a maximum of 20% of features should be tested when total features are less than 30. The test data should be distributed throughout the project and obtained by either a method that is more accurate than or equally as accurate as the method used to collect the data. In other words, RTK GPS horizontal features might be tested by Total Station or RTK GPS. Total Station elevations might be tested by differential leveling or total station.

C. RMSE REPORTING

Since there are feature categories with varying relative accuracy standards, the RMSE analysis should be arranged in a chart for each feature category. A sample is shown below, but the format is not considered mandatory.

Table 4.2 (Assumes $RMSE_x = RMSE_y$)									
Point	x_{meas}	x_{test}	Δ_x	Δ_x^2	y_{meas}	y_{test}	Δ_y	Δ_y^2	$\Delta_x^2 + \Delta_y^2$
1									
2									
..									
30									
								Sum	
								Average	
								$RMSE_r$	
								Accuracy	

In Table 4.2 above, note there is no elevation (Z) value. A feature containing all three elements of position would require an additional table for Z values. The “Sum” is the sum of the squares of the differences. The “Average” is the average (mean) of the sum of the squares. The “ $RMSE_r$ (root mean square error)” is the square root of the average of the squares divided by the number of differences (count). In addition, note that Accuracy is computed based on two separate conditions; $RMSE_x = RMSE_y$ and $RMSE_x \neq RMSE_y$. Accuracy is 1.7308 ($RMSE_r$) and 1.2239 ($RMSE_x + RMSE_y$), respectively. For elevation data, $Accuracy_z = 1.9600$ ($RMSE_z$).

It could be argued that only one redundant measurement is insufficient to statistically analyze a measurement or position. However, even where there is only one degree of freedom, some statisticians recognize that when measurements are performed over and over using similar techniques and equipment, this “experience” can be related to the current measurement. In other words, the degrees of freedom may be perceived as increasing tremendously, approaching a “t value” of 1.96 (infinite population).

This distribution is sometimes referred to as a “Reference Distribution” or “Sampling Distribution.” This is founded on the principal that the probability of the measurements approaching the “Normal Distribution” is greater as the degrees of freedom increase.

VII. REPORTING AND DELIVERABLES

A. SURVEY REPORT

A Survey Report is required for each project. The Report must be prepared by or under the direct supervision of the Professional Surveyor in charge of the project and contain a Surveyor’s Certificate and Seal. The survey report should discuss all aspects of the Scope of Work based on the requirements of the project. There is no specified format, although the minimum contents are listed below and each surveyor is free to prepare the report in accordance with their professional opinion. The report is meant to record the aspects of the work that will enable others to understand the strengths and weaknesses of the survey. In particular, it will serve others expanding on this particular survey or using the data from this survey to perform other functions. It is important to note any unusual circumstances as well as to include all QA/QC checklists and documentation.

The report shall be in a format approved by the Department, but shall contain at a minimum the following information:

Title Page – Name of project, project number, consultant contact information.

Table of Contents – Reference section and page numbers, tables, figures.

Introduction – Project description, location, purpose, scope of work, dates.

Planning and Research – Detailed narrative of research items and tasks, Safety Plan.

Survey Tasks – Detailed narrative of all survey tasks, methodologies, equipment.

Data Processing – Detailed narrative of processing, software, results, scope items.

Testing and QA/QC – Detailed narrative of testing procedures, results, QA/QC checks.

Conclusions and Project Summary – Detailed narrative of deliverables, Certification.

Attachments – Research copies, raw data, adjustment results, QA/QC Plan, Safety.

Deliverables – Hard copies and digital files in accordance with Scope of Work.

VIII. SURVEY STATISTICS

A. GENERAL STATISTICS

The familiar tenet “no measurement is without error” is the basis for the need to analyze and compare measurement data. Statistics is the body of knowledge used to collect, organize, summarize, and analyze data (variables). Today’s survey standards, more than ever, rely on statistical evaluation to interpret survey measurements. Competent surveyors and engineers performing surveys for the Department need not be statisticians. However, a rudimentary understanding of the basic concepts of statistics is required to adequately adjust and report survey results. The primary goal of this Manual is not to teach anyone how to perform certain measurement functions, but rather to determine what is expected from the surveys and outline Department standards together with methodologies available today that will achieve those standards. To that end, a brief discussion of statistical terms, nomenclature, and functions is necessary to better understand the Standards required for various surveys and how to test and report the achieved results.

Data (variables) can be qualitative or quantitative, as well as discrete or continuous. Continuous variables can assume all values between two specific values as may be determined in any measurement. Data in its original form is raw data. Raw data can be grouped into frequency distributions from which data can be analyzed. Frequency distributions are no more than raw data listed in a table by class, number, and frequency of occurrence. One common analysis of the data would be an average. The term Average is sometimes an ambiguous term. There are different terms for average in statistics. Average is also called a “measure of central tendency.” Common measures of central tendency in statistics include the “mean (μ),” “median (MD),” “midrange (MR),” and “mode.” Knowing how data is dispersed around these central tendencies is useful in analyzing data.

These measures of dispersion are called measures of variation. Common measures of variation include the “range (R),” “variance (σ^2),” and “standard deviation (σ).” Simple equations to compute these values are readily available.

Continuous variables have distributions that are called “approximately normally distributed,” the familiar “bell curve” distribution. The standard normal distribution has a mean (μ) of 0 and a standard deviation (σ) of 1. In this normal distribution no variables fit the theoretical distribution curve perfectly, but the deviation from the normal curve should be small in most instances. The normal distribution is said to be symmetrical when data values are evenly distributed about the mean.

Distributions may also be negatively skewed or positively skewed. The area under the curve of a standard distribution is equal to 1.00 (100.00%). The area under the curve that lies within one standard deviation of the mean is approximately 0.6826 (68.26%); within two standard deviations of the mean approximately 0.9544 (95.44%); and within three standard deviations of the mean approximately 0.9970 (99.70%).

A “confidence interval” is a specific interval estimate of a parameter using data obtained from a sample (test population) and the “confidence level” of the estimate. The confidence level of an interval estimate of a parameter is the probability that the interval estimate will contain the parameter. Common confidence intervals used in analyzing data are 90%, 95%, and 99%. An interval of 95% is greater than an interval of 90%, giving greater confidence that the parameter will be contained in the range of the interval. The Central Limit Theorem states that when data (population) is large, approximately 95% of the sample means will fall within 1.96 standard errors of the population mean. The standard error is the standard deviation of the sampling distribution of a statistic. The term may also be used to refer to an estimate of that standard deviation, derived from a particular sample used to compute the estimate. There is a subtle difference in the equation for the standard deviation compared to the equation for the standard error.

An often-used estimate of positional accuracy is the “root mean square error (RMSE).” RMSE is the square root of the mean of a set of squared differences between the original data and the check (test) data. Some physical sciences use RMSE as a synonym for standard deviation (σ). Other disciplines note subtle differences.

The Federal Geographic Data Committee (FGDC) Geospatial Accuracy Standards suggests when testing mapping products, that when $RMSE_x = RMSE_y$, accuracy may be determined by 1.7308 (RMSE_r) at the 95% confidence level. When $RMSE_x \neq RMSE_y$, accuracy may be determined by 1.2235 ($RMSE_x + RMSE_y$). And, with respect to vertical accuracies, since it is linear in nature and not circular, $ACCURACY_v = 1.9600 (RMSE_v)$.

Least Squares Adjustments are an integral part of most every surveyor's and many engineers' understanding of error propagation. Since the onset of personal computers, a wide range of software has made the use of Least Squares Adjustments commonplace. Yet, it is surprising how few really understand the basics of good least squares adjustments. Prior to computers, any complex error propagation using least squares was a long and arduous computation—especially with the availability of much simpler adjustment processes, such as compass rule adjustments or others.

It should also be noted that not all least squares adjustment software is created equal, and the user should be aware of the differences and limitations.

Least squares connects the principals of probability with the normal distribution. In simple terms, its solution “minimizes the sum of the squares of the errors.” It is critical in the evaluation of complex networks that are more than simple closed loops. In addition, great benefits can be gained by the weighted solutions when combining measurements from different sources. To gain the most benefit, least squares adjustments should only be performed by experienced users familiar with the statistics and procedures of error propagation. The software is too easily manipulated by inexperienced users trying to obtain satisfactory results using improper procedures. The results of least squares adjustment yield important information with respect to statistical analysis and the reporting of accuracy standards.

B. GEOSPATIAL POSITIONING ACCURACY STANDARDS

The National Geodetic Survey (NGS) has adopted new accuracy standards for the National Spatial Reference System (NSRS). While these new accuracy standards supersede and replace the accuracy standards from FGCC 1984 and FGCC 1988, they are meant to primarily facilitate the existing and future NSRS. Separate and distinct guidelines are recommended for engineering, acquisition of right-of-way, and construction.

Therefore, the Department has officially adopted, by way of this Manual, separate and distinct accuracy standards to be used to establish project control and data collection for its projects. Geospatial Positioning Accuracy Standards are primarily used to establish points in the NSRS and other geodetic surveys. The Department does not require these standards to be met in the surveys required in support of its program. However, similar accuracy standards are proposed in the appropriate sections.

C. RELATIVE CLOSURE RATIO ACCURACY

Closure Ratios for horizontal and vertical points that have redundant measurements are still a valid standard with respect to both land surveys and engineering surveys and are still in use today by many agencies. However, if there are no redundant measurements it is impossible to compute or predict closure ratios. Traverses, differential leveling, and even differential GPS may all be evaluated using closure ratios. Traverse error can be described as directly proportional to the distance

between the points. Leveling error can be described as directly proportional to the square root of the distance leveled and GPS error can be defined as a constant or base error plus a proportional line length dependent error.

There is no easy correlation nor transformation between positional accuracy and relative closure accuracy. It is possible to estimate local positional accuracy based on closure ratios. For example, for a 1:50,000 closure ratio a distance of 1,000.00 feet between two points may be expressed by $1,000 \times 1/50,000 = 0.02$ foot. Thus the local positional accuracy for two points separated by 1,000.00 feet could be expressed as an estimated 0.04 feet at the 95% confidence level.

Likewise, for a differential level run with bench marks separated by a level circuit of 2.00 miles that does not close by 0.05 feet, it can be expressed as $0.05 \times \sqrt{2} = 0.07$ foot, or approximately 0.14 foot at the 95% confidence level.

The primary issue with closure ratios is that a majority of the various surveys performed today are radial in nature. That is, whether by total station or GPS, most data points are collected from a single control point, either a total station performing side shots, GPS performing RTK from a local base, or GPS performing RTK from a RTN. It is both too costly, as well as inefficient, to propose that 100% redundancy be used to acquire data to ensure that there is a means to perform error propagation. Thus, where no redundancy or closure can be computed, as in radial surveys, it is necessary to acquire test data (check shots) and analyze the data to report an accuracy and level of confidence.

CHAPTER FIVE
DESIGN SURVEYS

BUREAU OF DESIGN AND ENVIRONMENT
SURVEY MANUAL

May 2015

CHAPTER FIVE
DESIGN SURVEYS

Table of Contents

	Page
I. INTRODUCTION	5-1
A. Purpose of Design Surveys	5-1
B. IDOT Reference Guides	5-1
II. PLANNING AND DATA COMPILATION	5-2
A. Determination of Survey Requirements and Scope of Work	5-2
B. Compilation of Record Data	5-2
III. CONTROL FOR DESIGN SURVEYS	5-3
A. Primary Survey Control	5-3
B. Perpetuation of Prior Survey Control	5-3
IV. ALIGNMENTS	5-3
A. Field Establishment of Existing Alignment	5-3
B. Design-Provided Alignments	5-4
V. ROUTE TOPOGRAPHIC SURVEYS	5-4
A. Conventional Design Surveys	5-4
B. Surveys to Supplement Aerial Mapping	5-6
VI. CROSS SECTIONS, ELEVATIONS, AND DIGITAL TERRAIN MODELS	5-7
A. Introduction	5-7
B. Data Collection Process	5-7
VII. SPECIAL SURVEYS	5-8
A. Bridge Surveys	5-8
B. Stream and Floodplain Surveys	5-9
C. Railroads	5-10
D. Pipeline Surveys	5-12
E. Specific Site Surveys	5-12

CHAPTER FIVE

DESIGN SURVEYS

I. INTRODUCTION

A. PURPOSE OF DESIGN SURVEYS

Design surveys are detailed route locations, sometimes referred to as Preliminary Surveys or Existing Conditions Surveys. These surveys provide designers with accurate and specific data required to design the various elements of the proposed roadway improvements and to incorporate them into contract plans. Design surveys incorporate surface topography and terrain modeling; route alignments and profiles; information on above-ground and below-ground utilities; and all improvements within the survey limits. A design survey may be the first survey of a potential improvement corridor and may include setting primary survey control for the project, or may follow a prior survey and use the control previously established. On larger projects, conventional ground survey methods are often used to supplement aerial mapping with accurate pavement elevations, utility information, and areas obscured from aerial view. It may include determination of the existing corridor right-of-way if a separate right-of-way survey is not being done for the project. Design surveys are also performed on specific sites such as bridges, waterway crossings, railroad crossings, utility corridors, and intersection improvement surveys.

B. IDOT REFERENCE GUIDES

The Department has a number of other publications that provide instruction and guidelines to be used in the preparation of roadway plans and surveys. The primary publications are the [IDOT CADD Roadway Drafting Reference Guide](#) and the [IDOT CADD Roadway and Structure Project Deliverables Policy](#), as well as the [Bureau of Design and Environment Manuals and Documents](#). The CADD Roadway Drafting Reference Guide is a continually updated resource created in Portable Document Format (PDF) and is available on the [IDOT website](#).

The CADD Roadway Drafting Reference Guide provides criteria such as cell libraries, levels, text styles, drawing scales, and file names to be used in MicroStation and GEOPAK to generate survey drawings and contract plans.

It discusses the Survey Manager Database (SMD) file which is used by GEOPAK to translate survey data from electronic data collectors to MicroStation design files. It also contains detailed information on the use of GEOPAK for various design functions and calculations.

The CADD Roadway and Structure Project Deliverables Policy contains detailed information and FAQs on IDOT's Survey Point Code Descriptions, and discussion of the use of GEOPAK, which is required on any IDOT project requiring horizontal and vertical control.

The [Drainage Manual](#), particularly Chapter 2 (Drainage Studies and Hydraulic Reports), provides detailed information on topographic surveys done to support these studies and reports. These surveys will be discussed in greater detail in [Section VII. A.](#) and [VII.B.](#) of this Chapter.

II. PLANNING AND DATA COMPILATION

A. DETERMINATION OF SURVEY REQUIREMENTS AND SCOPE OF WORK

Prior to commencing design work for a proposed improvement, the Department will review existing information and determine the need for additional topographic mapping and design surveys. The District Chief of Surveys will coordinate with the designers to determine the survey requirements and prepare a Scope of Work which identifies specific project limits and survey needs, including field survey requirements and the specific format of all deliverables. Once this is complete, a project schedule and budget can be worked out. The Scope of Work is used by the Surveyor as guidance and as a checklist to ensure all required survey information is obtained and provided to the designers in a complete and timely manner. Surveys should be performed in accordance with accuracy requirements specified for the project or as outlined in [Chapter Four](#) of this Manual.

B. COMPILATION OF RECORD DATA

The Department will provide the Surveyor with prior survey data including: horizontal and vertical survey control; construction plans; right-of-way and centerline plats; prior design surveys or aerial mapping; and other pertinent documents from their internal records. Depending on the amount of information available from the Department, the Surveyor may need to perform additional research with sources such as NGS, USGS, local highway departments, cities, villages, utility owners, and survey firms.

III. CONTROL FOR DESIGN SURVEYS

A. PRIMARY SURVEY CONTROL

Design Surveys of a new roadway corridor of a roadway that has not been surveyed in some time may include establishing primary horizontal and vertical control.

[Chapter Two](#), Geodetic Surveying, and [Chapter Three](#), GPS, of this Manual both discuss establishment of primary project control.

B. PERPETUATION OF PRIOR SURVEY CONTROL

Design Surveys may also be performed following a centerline or right-of-way survey, or to supplement aerial design mapping or prior design survey. In these cases, the prior survey control shall be recovered, verified, and densified (if needed) prior to beginning the new design survey. When prior surveys are based on a horizontal datum other than NAD83 (2011), or a vertical datum other than NAVD88, the Department may require the Surveyor to update the project datum and provide a correlation of the prior survey control with the current NGS datum. This decision will be made by the Department on a project-by-project basis.

IV. ALIGNMENTS

A. FIELD ESTABLISHMENT OF EXISTING ALIGNMENT

Many surveys are performed for the purpose of rehabilitating an existing highway. Such a project normally involves horizontal or vertical realignment or regrading the section. In general, this type of survey will attempt to reproduce the original centerline.

Construction plans or surveys of the existing roadway will provide information on the record alignment, including centerline monuments and topographic features that can be used to re-establish the record alignment and stationing. These features shall be searched for in the field and tied during the project control survey.

In cases where the centerline is not monumented, the pavement is “split” and the existing centerline is tied to the project control. Depending on the type of existing pavement and safety considerations, this can be done by digging alongside the edges on both sides of the pavement until a good vertical face is uncovered. The distance from edge to edge is then measured and the pavement centerline is marked at the midpoint, or the edge of pavement may be referenced.

On urban highways, or roads with curb and gutter, the edges of the pavement may be located and “split” in the CADD file. The existing centerline of pavement should be tied to project control in both tangents and curves. A minimum of three points per tangent and three points per curve should be established.

The record alignment is generally computed in GEOPAK and compared with the existing centerline points surveyed in the field. On smaller projects with simple alignments this analysis may be done by the field crew, although the alignment will still need to be computed in GEOPAK for the project deliverables.

Once the alignment is established in the manner described above, the alignment can be stationed and monumented if required. The original survey stationing may or may not be used at the discretion of the Department. Station numerals in the pavement should not be used to establish the stationing for a survey but will provide an approximate check on the original stationing. If neither of these are available, a topographical feature such as a bridge, culvert, or a fence line may be used. In any case when re-establishing existing stationing, it should be checked at more than one location.

Current survey accuracy normally exceeds that of early pavements. Early roadways may have been built using survey accuracies exceeding 1 foot in a mile. In such instances, station equations may be used to establish record stations, but new stationing will likely be established.

B. DESIGN-PROVIDED ALIGNMENTS

In other cases, a design survey will be conducted along either an existing or proposed alignment determined from prior surveys or mapping. In this case, the Surveyor will often be provided with a GEOPAK chain of the alignments and instructed if this needs to be staked in the field or used only as a CADD reference file.

The CADD Roadway and Structure Project Deliverables Policy requirement for creation of a digital terrain model (DTM) and procedures for generating existing ground cross sections in GEOPAK have diminished the need to mark alignment stationing in the field. Many design surveys can be completed without monumenting and stationing the alignment, particularly on roadways with heavy traffic or high speed limits.

V. ROUTE TOPOGRAPHIC SURVEYS

A. CONVENTIONAL DESIGN SURVEYS

Topography shall be obtained within the project limits including, but not limited to: culverts and discharge pipes (with size, type, material, and invert elevation); catch basins; inlets; manholes; marked or visible pipelines; hand holes; transmission cables; overhead utility lines and poles; curb and gutter; pavement; sidewalk; retaining walls; guard rails; fences; and single trees 6 inches in diameter or greater at a point three feet above the highest ground level at the base of the tree or where planted for landscaping purposes.

To determine the diameter of a tree, divide the measured circumference by 3.1416. In areas of multiple trees or rows of trees, the outline should also be located. Generally, trees should be designated as deciduous or coniferous. Calipers or tree tapes may be used in addition to measuring the circumference. Special tree surveys may require genus and/or species indication.

The location of all overhead utility lines shall be recorded together with the ownership. Sometimes a utility pole may be jointly owned and carry more than one utility's cables or wires. If the elevation of the low wire is required, trigonometric leveling can be used to determine the height of power lines, since the use of a rod or tape for this purpose is dangerous. Terrestrial Laser Scanners are also a useful tool in locating overhead wire clearances and locations. Special consideration should be made to record temperature, wind and wind direction, and ice (if necessary). These climate variables can directly impact the position and sag of each line significantly. The climate data capture will at a minimum allow the engineer to make any considerations to the design as necessary.

Invert elevations of underground utility structures must be obtained, including pipe size and type information, along with detailed information on the type and condition of the structure. At valve vaults a top-of-pipe elevation shall be obtained. A predesigned manhole detail sheet is recommended to ensure all necessary information is recorded and noted. The utilities should be properly identified as storm sewer, sanitary sewer, water, telephone, gas, etc.

PLEASE NOTE: The Department's Policy for entry into confined spaces requires survey crews to take extensive safety measures when performing inspections or surveys of sewers, inlets, manholes, and culverts. See [Appendix D](#) for the details of the Confined Space Policy.

All right-of-way markers and property corner monuments discovered during the survey should be tied. Fence lines and the apparent ownership of the various tracts of land affected by the proposed improvement should be noted. Existing property fences should be measured at each cross section line, apparent property corners, and at any fence corner and/or angle point in the fence line.

All drainage structures surveyed shall be detailed with additional shots to accurately indicate drainage courses. Private drains, field tiles, house drains, and similar underground drainage facilities must be located and correctly coded to accurately reference type and size of each opening. Low points that do not drain or any other drainage problems should also be located.

All features that lie 50 feet beyond the proposed right-of-way lines should be included. Any critical buildings which are within 10 feet, and not greater than 25 feet, outside of the proposed right-of-way line shall also be located. The character of the adjoining land should be noted, such as: cultivated, pasture land, wooded, etc.

Information for intersecting roads and driveways must be obtained. Curb returns should be located from the point of curve on the mainline to the point of tangent on the side road, or further depending on project limits. The edges of pavement, centerline location, and profile of all side roads and driveways should be located to the centerline of the mainline.

At bridges, culverts, and railroads, special survey data points are required. [Section VII](#) of this Chapter covers these special surveys in further detail.

B. SURVEYS TO SUPPLEMENT AERIAL MAPPING

Conventional survey methods are also used to provide supplemental topographic survey information to larger projects initially surveyed by aerial methods. Conventional survey is used to provide more accurate pavement elevations, utility information, and elevations, and complete survey information in areas obscured from aerial view by vegetation or buildings.

The Surveyor will be provided with planimetric mapping generated from the aerial survey. The first step of the supplemental survey involves a field check of the aerial mapping to identify features requiring survey. Then check for changed conditions. The control from the aerial survey shall be recovered, verified, and densified as needed to allow survey of the features identified in the field check.

Total Station or GNSS methods may be used to obtain topographic survey information for both conventional and supplemental design surveys depending on accuracy requirements and field conditions. GNSS is not a viable option for all terrain types and attention should be paid to those areas requiring additional control points for conventional data collection methodologies. Overlapping pavement shots shall be observed and checked at the beginning of each setup, as well as additional check shots to any bench marks and control points that are visible, regardless of surveying methods employed.

Conventional survey is then incorporated into the project Microstation and GEOPAK files to update and complete the planimetric survey and DTM created from the aerial mapping.

VI. CROSS SECTIONS, ELEVATIONS, AND DIGITAL TERRAIN MODELS

A. INTRODUCTION

The CADD Roadway and Structure Project Deliverables Policy mandates that ground shots be taken to accommodate creation of a Digital Terrain Model. A Digital Terrain Model (DTM) represents the topography data of a project from which a Triangulated Irregular Network (TIN) can be extracted.

This Policy and the associated CADD Roadway Drafting Reference Guide provide procedures for developing a mathematical model of the terrain surface using GEOPAK within the Microstation graphic environment. The DTM is used by GEOPAK to create ground profiles and cross sections and display contours and drainage flow patterns. DTMs are also used by GEOPAK for computation of earthwork quantities from cross sections or DTM volume differences.

Chapter 3.16 of the [CADD Roadway Drafting Reference Guide](#) discusses earthwork computations.

The data imported to GEOPAK consists of points with known horizontal and vertical positions. The data can be collected through the use of photogrammetry or with survey instruments such as total stations, GPS receivers, and terrestrial or airborne LiDAR. Whichever procedure of collection is used, the data will consist of two types: breaklines and mass points.

Breaklines: Breaklines are lines consisting of data points with known “XYZ” values that define linear terrain features that have a uniform slope on either side of the line. Examples are ditch lines, ridge lines, edges of pavement, etc.

Mass Points: Mass points are points with “XYZ” values normally completed after the breaklines are defined and are used to fill in the areas where there are no breaklines. They are usually points collected on a grid pattern, or randomly at a specified density.

A TIN model is derived from a mathematical process which forms triangles representing the terrain surface based on the mass points and breakline data in the 3D drawing. GEOPAK DTM files are named with a .tin extension.

B. DATA COLLECTION PROCESS

Mass Points: The spacing of the grid pattern for mass point location will be determined by the required accuracy of the terrain model. For normal design work, the spacing should be about 50 feet. If an area requires additional data to further define the terrain, such as low and high spots or bend and curve points, then additional data points shall be collected at a smaller interval to accurately model the terrain.

Breaklines: Breaklines shall be identified to locate linear terrain features that have a uniform slope on either side of the line. A breakline acts as a “hinge” for any triangulation that would pass through them and represent a distinct interruption in the slope of a surface, such as a ridge, road, or stream. No triangle in a TIN may cross a breakline (in other words, breaklines are enforced as triangle edges). This prevents the TIN from “submarining” through ridges or “bridging” over drains.

Field data collected with Total Stations or GNSS rovers can be surveyed as cross sections or as a grid at an interval appropriate for the project terrain and accuracy requirements. IDOT’s Survey Point Codes allow the field crew to properly code the data as mass points or breaklines, as well as label feature attributes. The Survey Manager Database (SMD) ensures that field data is placed in the proper level within the CADD file and that the appropriate field data is used to generate the DTM. Field data collected with LiDAR will generate a “point cloud” of 3D data points. Proprietary software allows individual data points and breaklines to be “picked” from the point cloud using a technique known as “Virtual Survey.” Once the points are picked, they are assigned the appropriate Survey Point Codes and then imported to GEOPAK in the same manner as conventional survey data.

VII. SPECIAL SURVEYS

A. Bridge Surveys

Bridge surveys are uniquely dependent upon structure type and anticipated type of work. Survey equipment technologies can be one or a combination of the following: conventional equipment (Total Station and levels); GNSS; or Terrestrial Scanning. The Project Engineer should direct the survey crew in accordance to the project requirements.

See Chapter 2 of the [Bureau of Bridges and Structures Drainage Manual](#) for more details.

Typical items included in a bridge survey may include one or more of the following: bearing seat elevations; dimension and shape of piers; profile of crown of pavement on bridge deck; profile of edge of pavement along bridge deck; profile of crown of pavement and approach slabs; bottom of beam profile for all beams; distance between the backwall and the edge of all beams; vertical clearance at crown of pavement; alignment and general description of structure including dimensions and elevations; photographs; and all painted edge lines or changes in section grade.

Additional items may be required if the bridge spans a water course, such as: the High Water Mark; cross sections of the watercourse upstream and downstream; or the watercourse bottom measured radially from each pier.

Ensure all profiles include sufficient survey density to accurately depict each item. Include the coordinate location and orthometric height of all surveyed items.

All elevation data should be orthometric heights and referenced to the North American Vertical Datum of 1988 (NAVD88) unless otherwise specified.

The length of a bridge survey should normally start 1,000 feet before the beginning of the bridge, cover the length of the bridge, and extend for 1,000 feet beyond the end of the bridge. The DTM coverage should go from ROW to ROW through the stream for the bridge survey. If a railroad lies beneath the bridge, a railroad survey for 500 feet on each side of the bridge is required. If a bridge is over an existing road, a roadway survey for 300 feet on each side of the bridge is required.

B. Stream and Floodplain Surveys

Stream and floodplain surveys are part of the drainage survey. Drainage surveys are more fully discussed in the Department's [Drainage Manual](#).

Adequate drainage is essential in the design of highways since it affects the highway's serviceability and usable life, including the pavement's structural strength. If ponding on the traveled way occurs, hydroplaning becomes an important safety concern. Drainage design involves providing facilities that collect, transport, and remove stormwater from the highway.

Field surveying for floodplain mapping is uniquely different from topographic design surveys in that the data collected is not necessarily intended to describe a continuous DTM surface. The project complexity will determine the extent of the field survey and need for topographic mapping. These surveys will be discussed with the District Chief of Surveys. Topographic mapping, if available, should be used as part of the determination as to the type and amount of supplemental survey information that will be required. If topographic mapping is not available, please reference the Drainage Manual to determine the criteria and type of survey (field, topographic mapping, or a combination) to be conducted to support the topographic mapping.

Survey cross sections are typically requested in selected locations so as to depict the volumetric capacity of the flood valley. The following guidelines identify some of the typical requirements for floodplain mapping surveys:

- Proposed road alignments with adjacent rivers and their floodplains should have stream cross sections taken every 500-1,000 ft. A minimum of at least four surveyed points (which includes at least two points at the bottom) within the main channel and not be limited to only three points (two overbanks and one bottom of channel elevation).
- Stream profile shots should be taken at horizontal and vertical stream changes to a point just past the 1,000-foot flood plain section upstream and downstream. The stream profile would be used for a base line to generate the floodplain cross sections. The floodplain section locations should be taken as requested by the Hydraulics Engineer.

- Cross section survey points are required at significant breaks in the ground line. The highest density of survey points will probably lie in the flow channels. Floodplain data points should emphasize the general slope of the plain and its width.
- Survey data is also required to define the edge-of-water, high-water marks, change in vegetation (tree lines), high points on gravel bars, top and bottom of channel banks, the stream thalweg (low point in the flow channels), and any other significant physical features (e.g., buildings). This information is useful in developing a comprehensive map of the area.

It should also be known that several counties in Illinois have LiDAR data available, which was collected via aircraft and are complete county collections. Additional counties throughout the state are expected to be available in the next few years, with hopes of having the entire state completed in the near future. The following link contains a list of counties for which LiDAR data is currently available and can be downloaded at: <http://isgs.illinois.edu/nsdihome/webdocs/ilhmp/county/dsm-dtm.html>

C. Railroads

Railroad property is private property and, as such, individuals seeking access to railroad property for any reason are required to contact the railroad prior to entering the property. It is typically railroad policy to treat anyone found on railroad property without authorization as a trespasser. Most railroads charge a fee to provide you with the right to enter their property and contractors will need to purchase liability insurance to cover any damages suffered by the railroad on account of occurrences arising out of the work on or about the railroad right-of-way. The time it takes to submit the right to enter form and receive entry approval can take anywhere from 60-90 days or more. Early anticipation and preparation to obtain right of entry will benefit you in performing your survey within the allotted time frame.

Depending on the railroad and the particular situation, the railroad may require a flag person be present for safety before authorization of the right to enter is obtained. Railroads typically charge the flag person's time to the one gaining the right to enter, and this cost may be substantial.

A survey is required where a highway is constructed parallel or adjacent to a railroad or where a highway and a railroad intersect. The survey shall reference the railroad rails to the highway centerline and subsequent survey information for plan development:

- Location of all railroad accessories.
- Existing drainage structures and flow patterns.
- Railroad right-of-way.
- All mile markers within the project or reference to the nearest railroad mile marker.

If a project involves a parallel encroachment on the railroad right-of-way, include the following information in the survey:

- Distance to tracks (all measurements are referenced from the centerline of the tracks).
- Cross sections from the project to mainline tracks with ground line and top-of-rail elevations and/or base-of-rail.
- Topography to the mainline tracks.
- All drainage structures and channels between the road project and mainline tracks with elevations of flow line and top of structures.
- Nearest railroad right-of-way line to road project.
- Point of frog, point of switch, and any other geometric features within project limits.

If a project involves a grade separating crossing, include the centerline of the railroad a minimum of 300 feet left and right of the roadway survey centerline with appropriate topography and cross section at 25-foot intervals.

Regarding railroad right-of-way, curves are typically based on a simple circular curve. There are some special circumstances where the right of way was purchased a uniform distance from the track and a complex spiral curve was defined as the centerline.

Right-of-way and centerline definitions, especially when more than one track exists, can be extremely difficult to retrace given the changing ownerships over the 100-plus years and surveying measurement techniques; however, ascertaining as early as possible the Valuation Maps of the project area is imperative to successful retracement efforts.

A railroad gauge, the distance between the two rails that comprise a track, is 4 feet, 8-1/2 inches (56-1/2 inches or 4.708 feet or 1435 mm). This dimension is measured perpendicular from a point 5/8-inch below the top of rail. The distance between track centers is not uniform but certain minimum dimensions are controlled by the Federal Railroad Administration (FRA) and the Department of Transportation (DOT). The minimum in Illinois is 13 feet, 6 inches but it is left up to the Railroad to decide and typical ranges are from 14 to 16 feet.

D. Pipeline Surveys

Pipeline surveys are undertaken to locate existing structures for (a) consideration in engineering design, (b) purposes of utility relocation, and (c) right-of-way acquisition and negotiation.

It is important to locate all significant facilities. The following are lists of facilities and critical points to be located. Be sure to check the Chief of Surveys and/or Project Engineer for any required special facilities not listed.

Oil and Gas Pipelines:

- Intersection point with centerlines and/or right-of-way lines.
- For lines parallel to right-of-way—location ties are necessary to show relationship to the right-of-way lines.
- Vents.
- Angle points.
- Meter vaults, valve pits, etc.
- Pipeline Transport—i.e., liquefied petroleum gas, liquid fertilizers, and anhydrous ammonia.

Water and Sewer Lines:

- Intersection point with centerlines and/or right-of-way lines.
- For lines parallel to right-of-way—location ties necessary to show relationship to the right-of-way lines.
- Manholes, valve boxes, meter pits, crosses, tees, bends, etc.
- Elevation on waterlines, sewer inverts, and manhole rings.
- When appropriate, or when requested, draw a sketch of storm and sewer manholes identifying the type and size of pipes and the direction of flow. Also, indicate which structure the pipelines flow to or from.
- Fire hydrants.
- Curb stops.

E. Specific Site Surveys

The Manual cannot account for every type of surveying and recognizes there are many surveys that have not been discussed. The surveys discussed in this Manual are typical surveying solutions that are frequently requested. However, there are other surveys not mentioned including, but not limited to, historical and/or pit surveys.

If a survey has not been defined, the Chief of Survey will be responsible for detailing the surveying methodology (i.e., conventional, GPS, Terrestrial LiDAR, etc.), surveying procedures, data capture requirements, and expected accuracy for this requested surveying service.

CHAPTER SIX
PHOTOGRAMMETRY

BUREAU OF DESIGN AND ENVIRONMENT
SURVEY MANUAL

May 2015

CHAPTER SIX

PHOTOGRAMMETRY

Table of Contents

	Page
I. INTRODUCTION.....	6-1
A. Intended Use.....	6-1
B. Mission.....	6-2
C. Scope.....	6-3
D. Definitions.....	6-3
E. References.....	6-3
F. Trade Names.....	6-3
II. ACCURACY STANDARDS AND SPECIFICATIONS.....	6-4
A. Comparing Evolving Mapping Standards and Specifications.....	6-4
B. FGDC Standards.....	6-7
C. CSDGM Standards.....	6-7
D. Specifications.....	6-7
E. Accuracy Testing Versus Reporting.....	6-8
F. Metrics.....	6-8
F.1 Scales Expressed as Equations or Ratios.....	6-9
F.2 Metric Conversions.....	6-9
III. CHOOSING THE RIGHT TOOLS FOR THE PROJECT.....	6-9
A. General.....	6-9
B. Photogrammetry.....	6-9
B.1 Film Cameras.....	6-10
B.2 Digital Cameras.....	6-10
B.3 Fixed Wing Aerial Photography.....	6-11
B.4 Helicopter Aerial Photography.....	6-11
C. Aerial LiDAR.....	6-11
C.1 Fixed Wing LiDAR.....	6-12
C.2 Helicopter LiDAR.....	6-13
D. Integration of Spatial Data from Multiple Sources (Data Fusion).....	6-13
D.1 Mobile LiDAR.....	6-13
D.2 Static Terrestrial LiDAR.....	6-15
D.3 Supplemental Ground Surveys.....	6-15
E. Requisition Forms.....	6-16

IV. GROUND SUVEYS FOR PHOTOGRAMMETRIC MAPPING PROJECTS	6-18
A. General	6-18
B. Ground Control for Photogrammetric Mapping	6-18
B.1 Photogrammetric Control Layout.....	6-18
B.2 Constraints on Control Placements.....	6-18
B.3 Selection Criteria for Quality Check Points.....	6-19
B.4 Typical Control Layout for Strip by Strip Projects	6-19
B.5 Typical Control Layout for Multi-Flight Line Projects.....	6-20
C. Targeting Photogrammetric Control Points.....	6-20
C.1 Target Sizes for Various Scales of Aerial Photography	6-21
C.2 Target Color.....	6-21
C.3 Target Placement	6-21
C.4 Sources of Commercially Available Ready-Made Targets.....	6-24
D. Photo Control Surveys	6-24
D.1 Ground Control Survey Methods.....	6-25
D.2 Conventional Ground Control Specifications.....	6-25
D.3 Vertical Control by Conventional Survey Methods.....	6-26
E. Post Control	6-27
F. Control Point Annotation	6-27
F.1 Targeted Points on Target Diagram	6-27
F.2 Quality Control Points	6-28
F.3 Post Control Points	6-28
G. Field Annotation for Photogrammetric Mapping	6-28
G.1 Cultural Features to be Identified on Enlarged Photographs.....	6-28
G.1.1 General.....	6-28
G.1.2 Utilities	6-29
G.1.3 Transportation Routes.....	6-30
G.1.4 Classification of Structures.....	6-31
G.1.5 Drainage	6-31
H. Deliverables	6-31
I. Ground Control Deliverables.....	6-31
I.1 Ground Control Diagram	6-32
I.2 Photo Culture Information.....	6-32
V. GROUND SURVEYS FOR AIRBORNE LIDAR MAPPING PROJECTS	6-32
A. General	6-32
B. Ground Control for Airborne LiDAR Mapping.....	6-33
B.1 LiDAR Project Control Layout	6-33
B.1.1 Constraints on Control Placements	6-35
B.1.2 Distribution and Selection Criteria for Quality Points.....	6-36
C. Accuracy Testing of Airborne LiDAR Mapping.....	6-37
C.1 Testing Planimetry Generated by LiDARgrammetry.....	6-37
C.2 Testing DTM and Contours.....	6-37
C.3 FEMA Accuracy Testing	6-37
VI. APPENDICES.....	6-39

A. References.....6-39
B. Definitions6-41

CHAPTER SIX

PHOTOGRAMMETRY

I. INTRODUCTION

This is a major rewrite of the 2001 Chapter that principally addressed ground surveys for photogrammetric mapping and was characterized by traditional accuracy standards. This completely rewritten Chapter specifically addresses the significant changes in accuracy standards and the ground surveys to support current practices in photogrammetric and airborne LiDAR mapping. It also provides a quick review of the various aerial geospatial technologies currently used by the Department and compares them with complementary ground based technologies which are often deployed on the same project.

The integration of photogrammetric and airborne LiDAR data with spatial data acquired by mobile and static LiDAR and by field survey methods is also briefly described.

A. INTENDED USE

This Chapter presents procedural guidance, technical specifications, and quality control (QC) criteria for those performing the ground survey elements of photogrammetric and LiDAR mapping in support of IDOT requirements. It applies to all centers of the Bureau of Design and Environment of the Illinois Department of Transportation (IDOT) performing and/or contracting for aerial data acquisition, digital orthophotography, photogrammetric, and/or LiDAR mapping services in support of their mission.

It should also be used as a general guide in planning mapping requirements, determining the best tools for the job, developing contract specifications, and preparing cost estimates for aerial data acquisition and photogrammetric and LiDAR mapping. With the current rapid pace of “disruptive” technological developments, it is anticipated that the

frequency of future revisions will be dramatically increased. The most current version will be available electronically on the IDOT website (<http://www.idot.illinois.gov>) and will supersede any printed versions. Suggestions to improve or revise this Chapter or reports of errors or omissions should be transmitted to the Department's Aerial Surveys section.

This Chapter does not establish any legal or administrative interpretations of the Department's contracts. In the event that the terms of a contract and this Chapter are in conflict, the Chapter is subordinate to the contract.

B. MISSION

The Aerial Surveys section in the Bureau of Design and Environment produces digital maps by photogrammetric means from aerial photography obtained by Aerial Surveys or consultants. The digital data is compiled in a three-dimensional (3D) format and is used to produce topographic maps or digital terrain modeling (DTM) elevations. Horizontal and vertical field control is required to scale and orient a strip or block of photography. The Department's Aerial Surveys section uses softcopy analytical aerotriangulation procedures to densify photogrammetric control to the individual stereo model level in the office environment. This additional control supplements the field control data to provide the required control to perform photogrammetric mapping.

The Aerial Surveys section also produces digital maps and related products from 3D datasets acquired by consultants using airborne LiDAR sensors. Digital orthophotography is often prepared as a byproduct of topographic mapping prepared photogrammetrically, or from LiDAR data.

The Division of Highway's district offices or the Central Bureaus initiate most of the mapping projects completed by the Aerial Surveys section of the Department. All mapping requests should be coordinated through the respective mapping coordinator for the office requesting the topographic mapping.

The Aerial Surveys section is responsible for obtaining the aerial photography and airborne LiDAR data and properly identifying the ground control and accuracy test point requirements for the photogrammetric and LiDAR mapping processes.

C. SCOPE

The 2015 rewrite of this Chapter describes the most current of the ever-evolving accuracy standards, an understanding of which is essential for determining what spatial products are required for a given project. Next is a section describing the advantages and disadvantages of the technologies available to produce those products, standard procedures, and QC criteria followed by detailed descriptions of product deliverables. This includes fixed wing and helicopter aerial photography, topographic LiDAR, topographic and planimetric mapping, and delivery of digital geospatial data for use in computer-aided design and drafting (CADD) and Geographic Information Systems (GIS).

D. DEFINITIONS

Definitions of technical terms and abbreviations are provided at the [end of this Chapter](#).

E. REFERENCES

Source material for this Chapter and related publications are also listed at the [end of this Chapter](#).

F. TRADE NAMES

The use of trade names of commercial firms, commercially available mapping products, hardware, or software in this Chapter does not constitute their official endorsement or approval.

II. ACCURACY STANDARDS AND SPECIFICATIONS

The 2001 version of this Chapter focused on photo scale of film photography used for photogrammetric mapping of products with published map scale and contour interval. Whereas film photographs are commonly referred to by photo scale, a digital image file does not have a scale, *per se*, and can be displayed and printed at many different scales.

Ground sample distance (GSD) provides a better defining metric for digital imagery as acquired, and “pixel size” is now used as the linear dimension of a pixel’s footprint on the ground in a digital orthophoto. Also, with digital data, it is easy to zoom in and change the viewing or printed scale and/or contour interval of a mapping product without changing its underlying accuracy. Products that are so easily manipulated, often incorrectly, give a false impression of higher accuracy.

The American Society for Photogrammetry and Remote Sensing (ASPRS) [Accuracy Standards for Digital Geospatial Data](#) (ASPRS, 2014), provided in the [Reference section](#) of this Chapter, include accuracy thresholds for digital orthophotos and digital elevation data, independent of published map scale or contour interval, whereas the standard for planimetric data, while still linked to map scale, tightens the planimetric mapping standard previously published in the [ASPRS Accuracy Standards for Large-Scale Maps](#) (ASPRS, 1990) because of advances in digital imaging, triangulation, and geopositioning technologies. For photogrammetric mapping, this Chapter is primarily intended to cover those large-scale [i.e., 1:3,000 (1 inch = 250 feet) or larger] mapping products that support typical IDOT design mapping projects and include detailed feature mapping or topographic mapping; however, this Chapter also deals peripherally with smaller-scale mapping up to 1:24,000-scale (1 inch = 2,000 feet) that may support route selection, planning or environmental studies covering large areas.

A. COMPARING EVOLVING MAPPING STANDARDS AND SPECIFICATIONS

The new standards referenced above, ASPRS Accuracy Standards for Digital Geospatial Data ([ASPRS, 2014](#)), have replaced the ASPRS Accuracy Standards for Large-Scale Maps ([ASPRS, 1990](#)) and the ASPRS Guidelines for Vertical Accuracy Reporting for LiDAR Data ([ASPRS, 2004](#)). ASPRS 2014 includes accuracy thresholds for digital orthophotos and digital elevation data, independent of published map scale or

contour interval, but the new standard for planimetric data, while still linked to map scale or scale factor, tightens the planimetric mapping horizontal accuracy standards published in ASPRS, 1990, as shown in [Table 6.1](#). Whereas ASPRS 1990 identified Class 1 as standard high-accuracy maps, ASPRS 2014 uses Roman numerals and identifies Class II as standard, high-accuracy geospatial data.

The new Class I refers to extra high-accuracy geospatial data for more-demanding engineering applications, and Class III refers to lower-accuracy geospatial data suitable for less-demanding user applications. As shown in Table 6.1, the new Class III horizontal standard equals the old Class 1 standard, i.e., former standard high-accuracy products are now considered to be of lower accuracy than the standard. This is a major distinction between the old and new ASPRS standards. The [Appendix](#) of this Chapter provides tables and scales in both metric and English units produced by the same formulas used to create the metric tables used by ASPRS. ASPRS 2014 should be used for specifying the horizontal and vertical accuracies required for geospatial data produced from aerial and/or satellite sensors, and for testing and reporting the accuracy of geospatial datasets

Table 6.1 Comparison of Old and New ASPRS Horizontal Accuracy Standards for Planimetric Maps.

Map Scale	ASPRS 1990 Accuracy Standards for Large-Scale Maps			ASPRS 2014 Accuracy Standards for Digital Geospatial Data		
	Class 1 RMSE _{xy}	Class 2 RMSE _{xy}	Class 3 RMSE _{xy}	Class I RMSE _{xy}	Class II RMSE _{xy}	Class III RMSE _{xy}
1:600 (1" = 50')	0.5 ft	1.0 ft	1.5 ft	0.25 ft	0.375 ft	0.5 ft
1:1,200 (1" = 100')	1.0 ft	2.0 ft	3.0 ft	0.5 ft	0.75 ft	1.0 ft
1:2,400 (1" = 200')	2.0 ft	4.0 ft	6.0 ft	1.0 ft	1.5 ft	2.0 ft
1:4,800 (1" = 400')	4.0 ft	8.0 ft	12.0 ft	2.0 ft	3.0 ft	4.0 ft
1:6,000 (1" = 500')	5.0 ft	10.0 ft	15.0 ft	2.5 ft	3.75 ft	5.0 ft
1:12,000 (1" = 1,000')	10.0 ft	20.0 ft	30.0 ft	5.0 ft	7.5 ft	10.0 ft
1:24,000 (1" = 2,000')	20.0 ft	40.0 ft	60.0 ft	10.0 ft	15.0 ft	20.0 ft

Regarding vertical accuracy standards, the ASPRS Accuracy Standard for Digital Geospatial Data (ASPRS, 2014) continues to specify RMSE_z as one-third the appropriate contour interval supported. For LiDAR data, it establishes recommended minimum Nominal Pulse Density and maximum Nominal Pulse Spacing; it establishes LiDAR relative accuracy swath-to-swath in non-vegetated terrain in terms of vertical RMS differences (RMSE_z) and maximum elevation differences; and it establishes Non-

vegetated Vertical Accuracy (NVA) and Vegetated Vertical Accuracy (VVA) at the 95% confidence levels for ten (10) Vertical Accuracy Classes (Class I through X), chosen for the following reasons:

- Class I elevation data, the highest vertical accuracy class, appropriate for 3-cm contours, is most appropriate for local accuracy determinations and tested relative to a local coordinate system, rather than network accuracy relative to a national geodetic network.
- Class II elevation data, the second-highest vertical accuracy class, appropriate for 7.5-cm (~3") contours, could pertain to either local accuracy or network accuracy.
- Class III elevation data, appropriate for 15-cm (~6") contours, approximates the accuracy class most commonly used for high-accuracy engineering applications of fixed wing airborne remote sensing data.
- Class IV elevation data, appropriate for 1-foot contours, approximates Quality Level 2 (QL2) from the National Enhanced Elevation Assessment (NEEA) when using airborne LiDAR point density of 2 points per square meter, and Class IV also serves as the basis for USGS' nationwide 3D Elevation Program (3DEP). Class IV elevation data are equivalent to that specified in the [USGS LiDAR Base Specification Version 1.0](#) (USGS, 2012).
- Class V elevation data are equivalent to that specified in the prior USGS LiDAR Base Specification Version 1.0 (USGS, 2012).
- Class VI elevation data, appropriate for 2-foot contours, approximates Quality Level 3 (QL3) from the NEEA and covers the majority of legacy LiDAR data previously acquired for federal, state, and local clients.
- Class VII elevation data, appropriate for 1-meter contours, approximates Quality Level 4 (QL4) from the NEEA.
- Class VIII elevation data are appropriate for 2-meter contours.
- Class IX elevation data, appropriate for 3-meter contours, approximates Quality Level 5 (QL5) from the NEEA and represents the approximate accuracy of airborne IFSAR.
- Class X elevation data, appropriate for 10-meter contours, represents the approximate accuracy of elevation datasets produced from some satellite-based sensors.

B. FGDC STANDARDS

[FGDC Geospatial Positioning Accuracy Standards, Part 4: Standards for Architecture, Engineering, Construction \(A/E/C\) and Facility Management](#) is published by the Federal Geographic Data Committee (FGDC). These standards can be used as a reference for geospatial data produced from ground surveys and for recommended geospatial data accuracies and tolerances for engineering, construction, and facility management projects.

C. CSDGM STANDARDS

[Content Standard for Digital Geospatial Metadata](#) (CSDGM). Geospatial metadata provides descriptive information in a standard format about geospatial datasets. Metadata describes the content, quality, fitness for use, access instructions, and other characteristics about the geospatial data. Geospatial metadata increases the longevity of geospatial data by maximizing its use. IDOT may consider specifying that all photogrammetric and LiDAR mapping projects include Metadata fully compliant with the CSDGM (<http://www.fgdc.gov/metadata/csdgm>). Guidance for implementing this standard can be found in the U.S. Army Corps of Engineers (USACE) publication EM 1110-1-2909.

D. SPECIFICATIONS

Geospatial specifications also promote cost-effective solutions for most of the same reasons as geospatial standards; but specifications normally pertain to data intended for a specific application, whereas standards pertain to all applications. A current example is the USGS LiDAR Base Specifications Version 1.0, published in 2012, which documents requirements for LiDAR data at three of the most common Quality Levels (QL). QL1 and QL2 LiDAR data (both with 1-foot contour accuracy but different LiDAR data point densities) ensure that the LiDAR point cloud and derived data products are suitable for the inter-Agency national 3D Elevation Program (3DEP), and QL3 LiDAR data (with 2-foot contour accuracy) ensure that bare-earth digital elevation models (DEMs) derived from the LiDAR data are suitable for incorporation into the National Elevation Dataset (NED). The USGS LiDAR Base Specifications Version 1.0 are included in the [Appendix](#) of this Chapter. Typically all design mapping performed for or

by IDOT would minimally conform to USGS Quality Level 1 (QL1). However in cases where IDOT uses very low-altitude aerial photography or LiDAR data to prepare detailed mapping for pavement resurfacing projects, the USGS Specifications do not provide guidance. It is a simple matter however to extrapolate from the $RMSE_{xy}$ for map scale 1:XXX (as seen in [Table 6.1](#)).

E. ACCURACY TESTING VERSUS REPORTING

ASPRS 1990 Standards instruct that: “Testing for horizontal accuracy compliance is done by comparing the planimetric (X and Y) coordinates of well-defined ground points to the coordinates of the same points as determined by a horizontal check survey of higher accuracy. Testing for vertical accuracy compliance shall be accomplished by comparing the elevations of well-defined points as determined from the map to corresponding elevations determined by a survey of higher accuracy. For purposes of checking elevations, the map position of the ground point may be shifted in any direction by an amount equal to twice the limiting RMS error in position.” These standards also state that “discrepancies between the X, Y, or Z coordinates of the ground point, as determined from the map and by the check survey, that exceed three times the limiting RMS error shall be interpreted as blunders and will be corrected before the map is considered to meet this standard.” “A minimum of 20 checkpoints shall be established throughout the area covered by the map and shall be distributed in a manner agreed upon by the contracting parties.” Check points can be concentrated more heavily in areas of interest. If the map is not tested for accuracy, but collected in such a manner to ensure compliance with stated class accuracies, then the following statement would appear in the title block: “THIS MAP WAS COMPILED TO MEET THE ASPRS STANDARD FOR CLASS 1 MAP ACCURACY.” Maps checked for compliance and found to conform to stated class accuracies would have the following statement in the title block: “THIS MAP WAS CHECKED AND FOUND TO CONFORM TO THE ASPRS STANDARD FOR CLASS 1 MAP ACCURACY.”

F. METRICS

Both metric SI (System Internationale) and non-metric (non-SI) English systems of measurement are used in this Manual due to the common use of both systems throughout the surveying, mapping, and photogrammetric professions. The ASPRS

Accuracy Standards for Digital Geospatial Data (ASPRS, 2014) noted in the [Appendix](#) are provided in both metric and in non-SI units, using the same mathematical formulas, but with English units.

F.1 Scales Expressed as Equations or Ratios

Metric scale ratios are often referenced in accuracy standards and specifications. Both English and metric scales are expressed in this Chapter. English scales are often expressed as “1 in. = X ft” notation, or, “X ft/in.” Unit ratio (i.e., 1:X) scale measures are also used for English units and are used exclusively for metric units. For example, a 50-scale map represents a 50-ft/in.-scale map, or 1 in. = 50 ft, or 1:600. The use of ratio to express scale is the preferred method.

F.2 Metric Conversions

Metric conversions are always based exclusively on the US Survey Foot which equals exactly 12/39.37 meters.

III. CHOOSING THE RIGHT TOOLS FOR THE PROJECT

A. GENERAL

The proliferation of geospatial data collection technologies in recent decades offers multiple solutions to the fundamental problem of capturing and representing field conditions to the engineer for civil design and related activities. No single technology provides the ultimate solution to that task, but the technologies are often complementary and understanding the characteristics of each enables the surveyor to select those most appropriate to a particular project. This section primarily serves to compare the products from various technologies and to summarize their respective advantages and disadvantages.

B. PHOTOGRAMMETRY

Digital photogrammetry, also called softcopy photogrammetry, began to replace analytical photogrammetry in the 1990s with the introduction of digital stereo photogrammetric workstations and high-resolution scanners that converted film into digital imagery. The more recent advent of modern digital metric cameras has further established softcopy photogrammetry as the dominant technology.

First among the advantages of photogrammetry is the richness of the data collection possible from color or multi-spectral aerial imagery. Second is the width of coverage based on a single flight line. Once acquired, the mapping corridor width can readily be expanded and a variety of image and geospatial products can be generated. Finally, Aerial Photogrammetry is a very mature and well-understood technology with few surprises. It is still the most utilized technology and is readily compatible with data from LiDAR or conventional ground surveys.

B.1 Film Cameras

Film cameras and photogrammetric procedures have long been developed. The principle photo acquisition flight planning parameters include flying height above mean terrain (AMT), camera focal length (topographic mapping lens with a 6-inch focal length is standard), forward overlap (typically 60%), and percent sidelap (typically 30%). The success of a photo acquisition project remains unknown until the film is processed in a photo lab and the imagery is examined to determine if there are any issues. Only then is it known if re-flights are necessary. Even then, faulty optical scanners or faulty scanning procedures have sometimes damaged the film, causing the need for re-flights.

B.2 Digital Cameras

With the use of digital cameras, the flight planning parameter changes from photo scale to ground sample distance (GSD). GSD is a function of flying height, lens focal length, and the pixel size of the charge-coupled device (CCD) sensors in the camera. The rules for forward overlap and sidelap are basically the same as film, except that it is much easier to acquire digital images with 80% or even 95% forward overlap for production of true orthophotos in urban canyon areas to minimize perspective building lean. The major advantage of digital cameras is that the camera operator can view acquired thumbnail images in flight to determine if correct areas were successfully acquired with cloud-free imagery and

determine, in near-real time, whether there is a need to re-acquire selected areas or strips.

A GNSS receiver linked with an Inertial Measurement Unit (IMU) installed in the aircraft is used to determine the precise (XYZ) position of the aerial camera at the instant of exposure (the Camera Station) to further strengthen the photogrammetric control solution and enable the use of fewer and more widely spaced ground control points.

B.3 Fixed Wing Aerial Photography

Fixed wing twin-engine aircraft are the most cost-effective platforms for most aerial photography for photogrammetric mapping applications. They have the ability to carry multiple sensors, including large-format aerial cameras for either film or digital imagery capture.

B.4 Helicopter Aerial Photography

Helicopters can fly slower than fixed wing aircraft and can legally operate at lower altitudes. Thus, they are able to obtain more detailed aerial photography from which more precise measurements can be made. The trade-offs are a reduced field of view at lower altitudes and the greater operating expense of the helicopter compared to the fixed wing.

C. AERIAL LIDAR

Aerial LiDAR data acquired from fixed wing aircraft or helicopter platforms is now routinely used for IDOT projects, as is data from Mobile LiDAR systems and from Static Terrestrial LiDAR systems. LiDAR's best application is fast and detailed collection of 3D point clouds of the earth and the objects thereon for the production of true orthophotos and DTMs.

A major advantage of Aerial LiDAR over Photogrammetry is that the data acquisition is not as weather dependent. LiDAR can readily be acquired under cloud cover, or at night for that matter. Another important advantage of Aerial LiDAR is the ability to capture a

wider swath of data compared to Mobile or Static Terrestrial LiDAR and to more efficiently capture very high-accuracy geospatial data (such as that required for road resurfacing projects) than using Photogrammetry based on fixed wing aerial photography.

Further benefits in accurately depicting above-ground features can be derived by developing images from the LiDAR data itself. While being typically of much lower resolution and illuminated by a narrower light bandwidth, LiDAR-generated images are not substitutes for conventional orthophotos. But, when the application is measurement and relative positional analysis of objects above the ground surface, the LiDAR image can be superior (especially in the case of objects such as overhead structures or wires whose position is not easily corrected in even conventional “true” orthophotos).

An important advantage shared by Aerial LiDAR, and to a lesser extent by Mobile and Static Terrestrial LiDAR, is the relative safety and security of survey staff working from outside a potentially busy highway. A reduction in the need to divert traffic is a companion advantage.

The principal disadvantage of Aerial LiDAR for many corridor projects, especially those in urban areas, is the inability of the scanners and accompanying cameras to capture the facades of buildings and other vertical objects so that data and imagery exists to correctly portray them in the final mapping. Another, of course, is the inability of aerial sensors to capture subsurface information, such as tunnels.

And finally, there is a practical limitation on data accuracy attainable from an aerial platform, whether transported by fixed wing or helicopter, compared with that obtainable by Mobile or Static Terrestrial LiDAR.

C.1 Fixed Wing LiDAR

Fixed wing aircraft are the most cost-effective platforms for many LiDAR data acquisition projects in terms of both mobilization and on-site operating costs.

C.2 Helicopter LiDAR

Helicopters can fly slower than fixed wing aircraft and can legally operate at lower altitudes. Thus it is possible to obtain a more dense and accurate dataset. The trade-off is a reduced field of view at lower altitude.

D. INTEGRATION OF SPATIAL DATA FROM MULTIPLE SOURCES (DATA FUSION)

The use of Photogrammetry or Aerial LiDAR requires field completion by field survey methods, especially for items not visible from the sky (i.e., manhole depths, underside of bridge, headwall pipe diameters, etc.). Some of this data can be acquired by Mobile LiDAR or Static Terrestrial LiDAR, but the need for gathering limited supplemental data by conventional surveying may remain. (See [Chapter 8](#) of this Manual for more on Terrestrial Laser Scanning.) Nonetheless, the fusing of data from Aerial Photogrammetry or Aerial LiDAR and Mobile or Static Terrestrial LiDAR datasets to create a single comprehensive dataset provides the user with widespread coverage over a large area and high-resolution detail in specific areas. Most typically, the aerial data provides the foundation for the topographic information and the Mobile or Static Terrestrial LiDAR data provides detailed information about the infrastructure.

Performing data fusion operations between these disparate data sources requires a sound understanding of the technologies, as well as the capabilities and limitations of each source. Though aerial and mobile acquisition missions generate spatially located point features in a common file format, there are a host of differences in parameters, such as collection speed, point density, age of data, and nadir or oblique views, etc., as well as positional accuracy that present challenges. In the end, however, the value of the final product makes the effort worthwhile.

D.1 Mobile LiDAR

Mobile LiDAR systems employ multiple LiDAR sensors, digital cameras with GNSS/IMU position/navigation systems, to collect high accuracy point data and imagery quickly and cost-effectively.

Some of the advantages of mobile LiDAR over aerial mapping and conventional ground surveys include day or night operation and high point density (up to 150 points per square foot). Typical data sets from mobile LiDAR surveys include relative accuracy of points within the scanned data of better than 0.03 feet and “absolute” accuracy of the points based on Global Navigation Satellite System (GNSS) projects of better than 0.05 feet.

Other benefits of mobile LiDAR scanning include:

- Increased safety over conventional surveying: Significantly reduces exposure of field staff to traffic hazards and reduces the need to divert traffic.
- Cost savings: Mobile LiDAR scanning gathers all required data point measurements in one pass, eliminating the need for additional mobilization.
- Time savings: Mobile LiDAR systems can collect up to 400,000 points per second. This is exponentially faster than conventional surveying.
- More complete data: This enables the user to identify and accurately locate more features than aerial methods.

The principal disadvantage of the mobile mapping system for many corridor projects is the inability of the scanners and accompanying cameras to see “behind” objects along the corridor, such as heavy vegetation, large signs, or buildings. Another disadvantage is the inability of mobile LiDAR systems to work in tunnels and in some “urban canyon” environments where adequate satellite signals are blocked, meaning some detail may still have to be captured by conventional surveying or by static terrestrial LiDAR surveying methods. Both of these disadvantages are readily overcome by combining the use of mobile mapping with aerial photogrammetric mapping or aerial LiDAR.

Recognize that points are not evenly or consistently spaced, therefore, nominal spacing values are generalized figures that characterize an average density and may often be misleading.

D.2 Static Terrestrial LiDAR

Static Terrestrial LiDAR, also referred to by some as Static Scanning or High-Resolution Surveying, offers the highest resolution and highest accuracy laser scanning compared to scanning from aerial or mobile platforms. And, like aerial scanners, the Static Terrestrial LiDAR systems typically incorporate digital cameras for the simultaneous acquisition of imagery. The resolution of the data acquired is in the real-time control of the scanner operator.

The first major advantage is that the use of Static LiDAR limits crew members' exposure to traffic, reduces traffic control costs and traffic congestion, while improving the safety of field personnel and motorists. The second major advantage is Static LiDAR can collect accurate data in a fraction of the time needed for collection by conventional methods. A third advantage, this time compared to Mobile LiDAR, is that when performing static scanning, original equipment manufacturer (OEM) programs, such as Leica's Cyclone application, allow the user to have direct control over point densities. Once the area of interest has been isolated, the operator selects the desired resolution after determining the distance to the surface. The operator also can perform a detailed review in real-time to validate results.

A major disadvantage compared to Mobile LiDAR is that Static LiDAR scanning usually requires occupations on multiple stations to gather all information required and the surveying by conventional means of a larger number of targets throughout the area of interest.

D.3 Supplemental Ground Surveys

There will nearly always be a requirement for conventional ground surveys to provide geospatial data unobtainable by any other means or to establish quality test points for the data acquired by the newer technologies. The advantages and disadvantages are well known; the principal advantage being the relative ease of dispatching a survey crew to the field, and the fact that the data generated is well understood and the procedures are highly evolved. The disadvantages include safety, security, and efficiency issues. Costly traffic diversion is often required and the data acquisition rate of a conventional survey operation is a fraction of that of the more complex technologies.

E. REQUISITION FORMS

All mapping compiled by the Aerial Surveys section of the Department is done by request. A mapping request form should be completed and sent to the Aerial Surveys office along with a map segment delineating the area to be mapped. See [Figure 6.1, page 6-17](#), for a copy of a mapping request form.



ASC No. _____
**Request for
Photogrammetric
Mapping Products**

Aerial Surveys Project: _____ Accounting Code No.: _____

Date of Request: _____ Date Needed: _____

Map/Diagram Attached: Yes No

Project Description: Route: _____ County: _____

Limits: _____

Purpose for Mapping: _____

Total Mapping Length: _____ Miles

Total Mapping Widths: Planimetry _____ ft. Contours: _____ ft.

Products Requested:

Mapping

Standard Digital Topographic Map Scale 1: _____ or 1" = _____ feet Contour Interval: _____ foot

Note: Standard Mapping consists of MicroStation 3D files containing planimetric data, digital elevation model data and GEOPAK generated contours. Finished product shipment includes 2D planimetric files and a DEM file in ASCII text format.

Digital Orthophoto Map Scale 1: _____ or 1" = _____ feet

Digital Imaging

Digital Orthophoto Mosaic Scale 1: _____ or 1" = _____ feet

Scanned Photos

Miscellaneous

Mylar Positives: Scale 1: _____ or 1" = _____ feet

Other: _____ Scale 1: _____ or 1" = _____ feet

Survey Data

Survey Party Available: Yes No

Assistance needed with GPS control: Yes No

Remarks: _____

Requested by: _____

District/Bureau/Other: _____

Telephone: () _____

BDE 2292 (Rev. 3/02)

Figure 6.1

IV. GROUND SURVEYS FOR PHOTOGRAMMETRIC MAPPING PROJECTS

A. GENERAL

Horizontal and vertical field control is required to scale and orient a strip or block of photography. Photo control is the primary type of control used (pre-targeted). All points on the target diagram should be surveyed in to have values in X, Y, and Z. If for some reason you cannot accomplish this on a point, it can become a HPT or a VPT only. Any changes like this or changes to the location of the target outside of the target box will need approval from Aerial Surveys.

The Aerial Surveys section of the Department uses analytical aerotriangulation procedures to establish additional photo control in the office environment. This additional control supplements the field control data to provide the required control to perform photogrammetric mapping.

B. GROUND CONTROL FOR PHOTOGRAMMETRIC MAPPING

B.1 Photogrammetric Control Layout

The number of horizontal and vertical control points and the placement of the points relative to each photograph and each strip of photography shall be determined by the Aerial Surveys section.

B.2 Constraints on Control Placements

Strip/Block adjustment calls for a sufficient number and suitable distribution of control points. Depending on the length of each strip and size of each block, several groups of control points are required within the strip/block, apart from those at the beginning and the end.

B.3 Selection Criteria for Quality Check Points

Quality Assurance/Quality Control (QA/QC) checkpoints are used to test the horizontal accuracy of digital orthophotos and planimetric data and/or to test the vertical accuracy of elevation data. These RMSE statistics are then used to report the tested horizontal and vertical accuracy of geospatial data consistent with reporting requirements of the National Standard for Spatial Data Accuracy (NSSDA), i.e., “Tested __ (meters, feet) horizontal accuracy at 95% confidence level” and “Tested __ (meters, feet) vertical accuracy at 95% confidence level”. Four rules generally pertain to the survey of QA/QC checkpoints:

- 1) Horizontal checkpoints should be point features clearly identifiable on the ground and on the dataset being tested;
- 2) The survey procedure for horizontal and vertical checkpoints should yield accuracy at least three times better than required of the geospatial product being tested;
- 3) At least 1,000 feet from a horizontal and/or vertical control;
- 4) The checkpoints should be well distributed with at least 20% of the points located in each quadrant of the mapped area, spaced at intervals equal to at least 10% of the map sheet diagonal, if practical, to obtain such distribution.

B.4 Typical Control Layout for Strip by Strip Projects

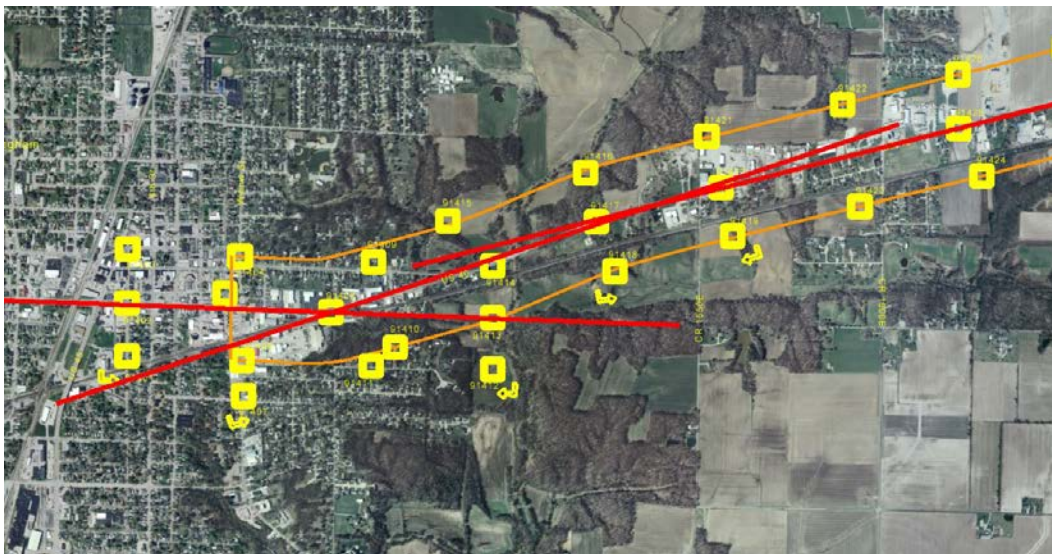

Figure 6.2

B.5 Typical Control Layout for Multi-Flight Line Projects

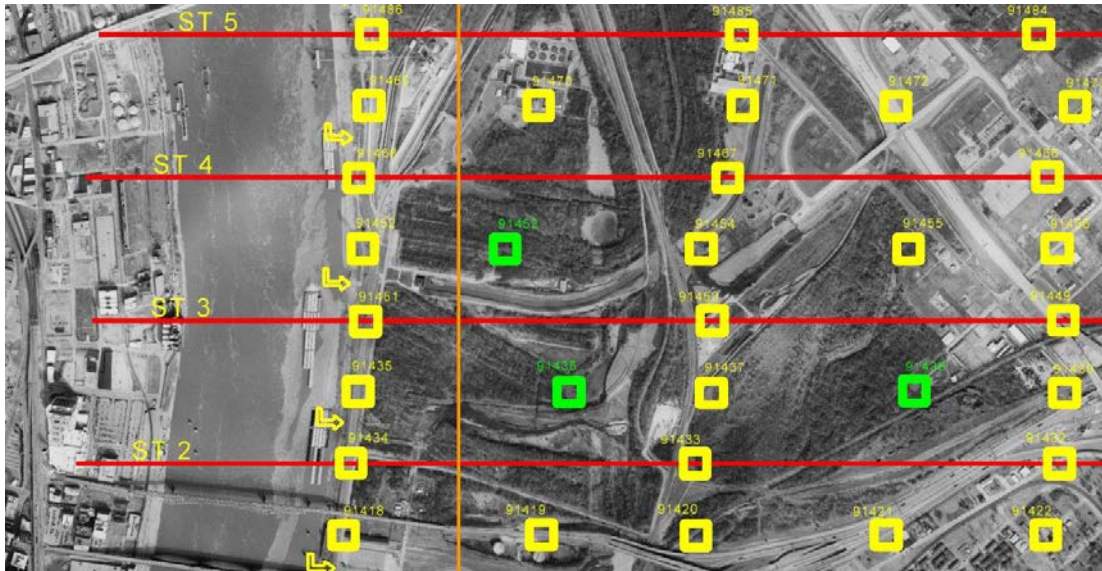

Figure 6.3

C. TARGETING PHOTOGRAMMETRIC CONTROL POINTS

A targeted project is one where target locations are pre-determined in the office. An enlarged photograph, Google Earth image, and/or Shapefile of the requested area to be mapped is used to indicate the locations of the horizontal and vertical control points, and the quality control points. Horizontal control point locations are more difficult to predetermine and may have to be adjusted on the project site.

To make it easier to accurately photo identify photogrammetric ground control, selected points on the ground are targeted with contrasting panels of material consisting of cloth, paint, or plastic, etc. These panels are made to specific dimensions and color depending on the scale of the photography and the color of the background where the targets are to be placed.

All target diagrams are drawn in Microstation. These drawings depict 250-foot square target boxes, flight lines, and mapping limits for each project. The targeted points will be placed somewhere within the target box.

C.1 Target Sizes for Various Scales of Aerial Photography

Targets must be of a size which will show up adequately on the particular scale of the photography being used, but should not be oversized, as this would reduce precision in measuring their position on the photos. The type of target normally used for design mapping is a muslin material with a black background and a four inch white strip forming a cross. Targets used for location studies mapping are made of a nylon material and come in a reversible black/white 1,000-foot roll in either a six- or twelve-inch width. The size used is based on the flight height. At some locations, paint may be the most economical material to use for targets and the size must adhere to the project requirements. [Figures 6.4](#), [6.5](#), and [6.6](#) display the target dimensions for different flight scales.

C.2 Target Color

Target color must take into consideration the background on which the target will be placed. When placing targets on new (less than one-year-old) blacktop surfaces, a yellow striping paint may be used quite effectively. For placing targets on concrete pavement, flat black paint is preferable. In situations where there is a very white background surface, the white background tends to bleed into the target. Therefore, a dark color wider than the standard width must be used. When placing targets off the roadway, similar ideas must be kept in mind for colors. In a plowed field with dark soil, white targets or light-colored targets work the best. In a plowed field of light sandy material, a dark or black target is the better choice.

C.3 Target Placement

A target should always be placed in an area clear of overhead obstructions. The area should also be as level as possible. The target is to be placed as precisely as possible over the control point being used as photo control. Level ground is especially important if the target is to be used for vertical control. If the target is being placed over a monument or control point whose elevation is known, the difference between the monument surface and the ground surface must be measured and recorded. The surveyor must indicate whether the monument surface is recessed or projecting relative to the ground surface. The legs of the target should be placed at 45° to the natural background lines (cultivation lines, pavement edge, etc.).

Targets should be placed so that they can be seen from the sky. If possible, they should be located in open areas away from trees and their shadows, away from areas where cars park or stop, or where they may be obscured by moving vehicles. They must be placed where vandalism by humans or disturbance by animals is minimized.

Figure 6.4

(Standard Aerial Photography Targets)

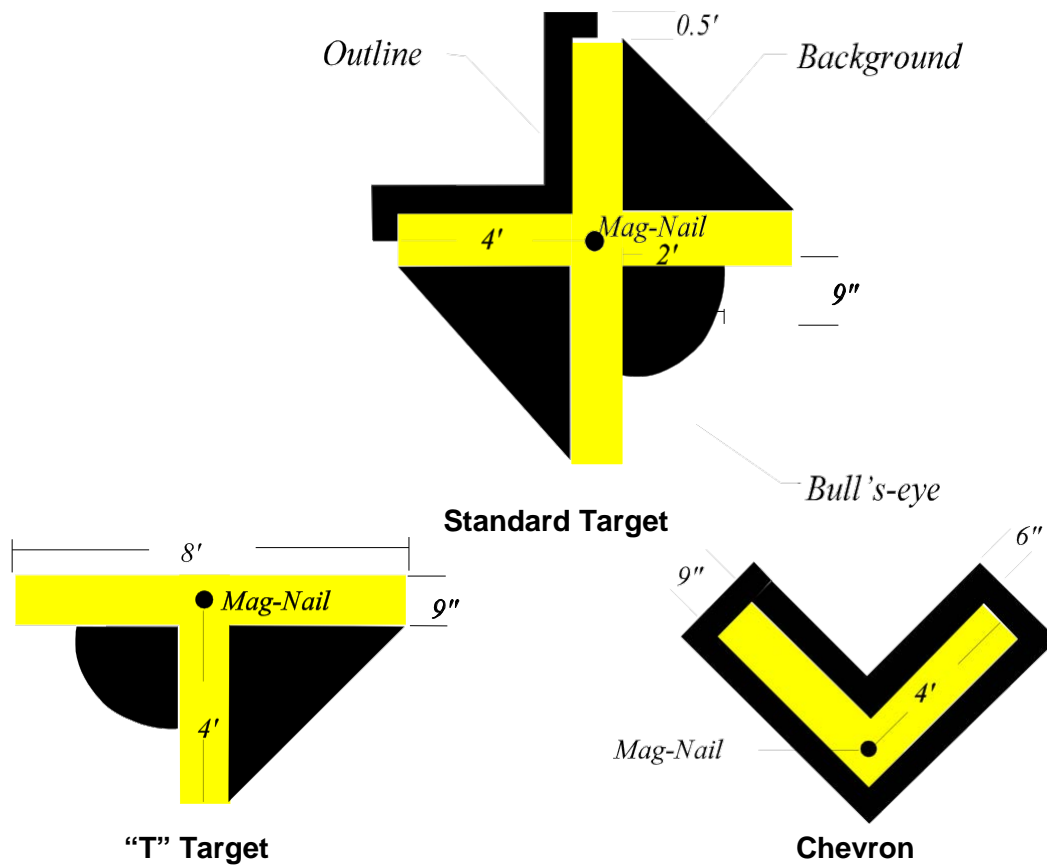

All painted targets must be highlighted in black by one of the following methods:

- Background
- Outline
- Bull's-eye

Figure 6.5

(High Level Aerial Photography Targets)

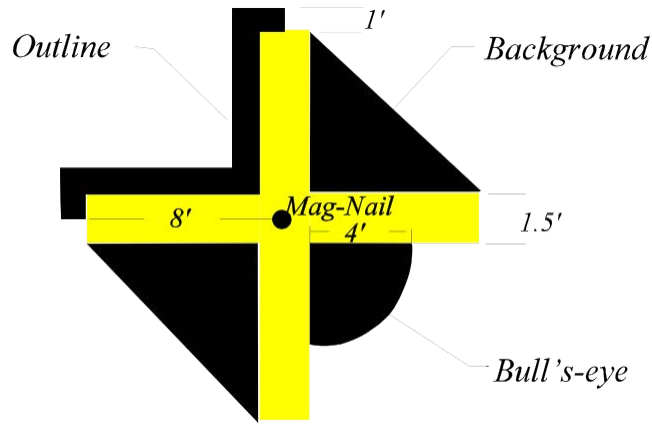

Standard Target

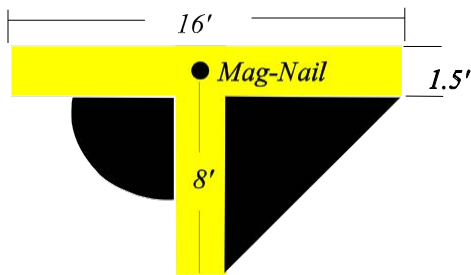

"T" Target

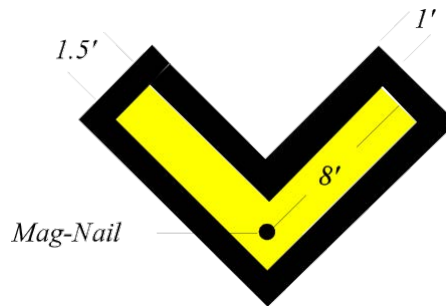

Chevron

All painted targets must be highlighted in black by one of the following methods:

- Background
- Outline
- Bull's-eye

Figure 6.6
(Helicopter Aerial Photography Targets)

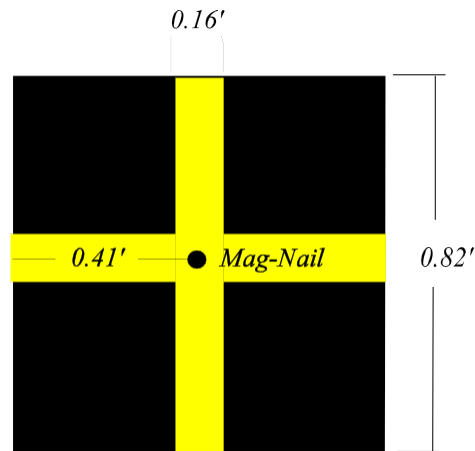

Helicopter Target

C.4 Sources of Commercially Available Ready-Made Targets

Below are links to suppliers of reusable Iron Cross and Bulls Eye targets in various sizes:

http://www.baselineequipment.com/home/bec/page_835

<http://www.padlockoutlet.com/Pre-Made-Aerial-Targets.html>

<http://www.mutualindustries.com/product/aerial-target-iron-cross> http://www.stakemill.com/index.php?main_page=index&cPath=382_248

D. PHOTO CONTROL SURVEYS

Horizontal photo control is required to orient the aerial photography stereo models to a known horizontal datum (typically NAD83) and provide a true scale ratio of ground distance and position to that represented on the photography.

Vertical control is required to provide elevations at photo-identified locations, which can be targeted points or Vertical Photo Ties (VPT). A level circuit through the project is required to establish project benchmarks and photo control points may be leveled to and from this line. Level lines for photo control points should start and end at different benchmarks (BM). Loops starting from and returning to the same BM are not acceptable. The North American Vertical Datum of 1988 shall be used for the vertical reference. Benchmarks shall be set and described with a “To Reach” description and local ties.

Quality Control Points (QP) are similar to a VPT in their selection. A QP can also be targeted. The procedure for the selection in the field is the same as the VPTs except that the pre-selected position will be along the centerline of the photograph, if possible. For targeted projects, the general location of the QP points will be shown on the enlarged photograph. Field survey procedures for these points are the same as for the VPTs.

D.1 Ground Control Survey Methods

Normally GNSS technology is used to establish horizontal and vertical positions for individual ground control points. See [Chapter 3](#) of this Manual on specifications for GNSS surveys for the required procedures. On some occasions such as when dense vegetation or “urban canyons” interfere with satellite signals traditional electronic traverse is used for ground control surveys. The field measurements shall be performed to achieve the Relative Positional Accuracy in Northing, Easting, and Elevation discussed in [Chapter 4](#) and shown in [Table 4.1](#).

D.2 Conventional Ground Control Specifications

- Traverses shall begin and close on existing National Geodetic Survey (NGS) control or new GNSS control stations.
- Coordinates are to be Illinois State Plane and referenced to the NAD83 (North American Datum of 1983).
- Traverse stations shall be established with semi-permanent monuments such as an iron rod, PK or MAG nail, chiseled cross or drill hole and described with local ties in the field book.

D.3 Vertical Control by Conventional Survey Methods

- Level networks shall begin and close on existing NGS bench marks.
- Orthometric heights are to be referenced to the NAVD88 (North American Vertical Datum of 1988) datum.
- All level networks shall be closed.
- Level networks closures shall meet or exceed third-order accuracy (See Table 6.2).

Table 6.2

ELEVATION ACCURACY STANDARDS

<i>Classification</i>	<i>Maximum elevation difference for Loop or Line</i>	
	<i>Metric</i>	<i>English</i>
First-order, class I	4 mm \sqrt{K}	0.017 \sqrt{M}
First-order, class II	5 mm \sqrt{K}	0.021 \sqrt{M}
Second-order, class I	6 mm \sqrt{K}	0.025 \sqrt{M}
Second-order, class II	8 mm \sqrt{K}	0.033 \sqrt{M}
Third-order	12 mm \sqrt{K}	0.050 \sqrt{M}

K equals the distance in kilometers and M equals the distance in miles.

Resource: Standards and Specifications for Geodetic Control Networks, dated September 1984

E. POST CONTROL

Post control is needed when a targeted point does not show up on the photography, or when the point is destroyed before the surveyor can determine its XYZ. This can be done using two methods. One would be when the triangulation operator would determine the type of photogrammetric identity he/she needs and selects the location from a stereo view in the triangulation program. In doing this, they would capture a screen shot of the point along with a description and estimated coordinates. This information is then given to the surveyor, who finds the location on the project and surveys the appropriate values.

The second method would be utilizing the full scanned images. The surveyor would acquire the digital images that the missing target would be viewed in, or the images where the new point could be picked from. Using image viewing software, the surveyor would pick a point that could be seen in at least two images. This would verify that the point would be able to be viewed in stereo. The exact location and label can then be added to a cropped view of the image. Once the location is determined, survey the appropriate values needed. A printed copy, along with the digital information, will be included with the project's deliverables. Point numbering for Post Control will be described in the Control Point Annotation section below.

Some examples of good post-marked control points are corners of sidewalk intersections, corners of driveway/sidewalk intersections, painted stop bars, lane stripes, corners of drop inlets, etc. These points must be clearly described on the photographs and properly identified.

F. CONTROL POINT ANNOTATION

The following numbering system should be used for annotating photogrammetric control points:

F.1 Targeted points on target diagram

Example: 91401 91410 914100 914999

First digit: Type of control: All points, whether XYZ or XY are labeled with a 9; Z-only points are labeled with a 7.

Second and Third digit: Year established--- 14 = 2014

Fourth digit - Sixth digit: Point number = 01 up to 999

F.2 Quality Control Points

Example: 31401 31410 31499

First digit: Type of control: All Quality Control points begin with a 3

Second and Third digit: Year established--- 14 = 2014

Fourth and Fifth digit: Point number = 01 up to 99

F.3 Post Control Points

Example: 99901 99955 77701 77755

First digit - Third digit: XYZ or XY use 999; Z only use 777

Fourth and Fifth digit: Use the point number of target it replaces, or the next available target number.

G. FIELD ANNOTATION FOR PHOTOGRAMMETRIC MAPPING

All mapping projects used for design purposes need to have culture identification completed in the field. For location mapping, only those features that are identified on the U.S. Geological Survey 7.5-minute quadrangle maps will be identified on the location map, unless the requester specifies otherwise.

All cultural features are to be identified on contact prints of the aerial photography.

G.1 Cultural Features to be Identified on Enlarged Photographs

G.1.1 General

- All culture is to be **legibly** identified on the photo enlargements.
- Use blue or black pen/marker for all labeling.
- Label culture within the limits outlined on the enlargements.

If **special nomenclature** is necessary, place a legend on the back of several photos and write "legend on back" in a corner on the front of that photo. Otherwise, use this guideline:

G.1.2 Utilities

TYPE

Fire Hydrant
Public Telephone
Manholes

Label

FH
PAY TEL
UMH







SYMBOL for the following: ©

- Electric
- Gas
- Telephone
- Sanitary
- Traffic Signal
- Other Utility Manholes

SMH



- Storm Sewer Manholes

Utility Poles: Add enough symbols to make clear each type of line.

<u>TYPE</u>	<u>SYMBOL</u>
Power	
Telephone	
Light	
Guy	
Traffic Signals	TS or 
Traffic Signal Control Box	TCB
Catch Basin / Inlets	DI
Vent Pipes	VP
Handholds	HH or 
Underground Utilities	Label AGS or Symbolize  with added label
<u>TYPE</u>	
Telephone	TEL
Gas	GAS
Electric	ELEC
Fiber Optic	OPT

 Warning signs--Symbolize with  and label as above.
 Do not symbolize or label signs that are attached to the AGS Box.

G.1.3 Transportation Routes

- Names-- Preferably obtained "in the field" or by using the most current map, technology such as Bing or Google, etc. VERIFY!
- Routes
- Streets
- Railroads
- Road dimensions are not required but can be helpful. (We plot by sight of photography.)
- Curb and Gutter
 - Dimensions are recommended
 - Dimensions should be to the nearest 0.1 foot
- Traffic Signs-- Symbolize with  and label "T"
- Advertising Signs-- Symbolize with 
- Bike Path BIKE

Classification of all Driving Surfaces

	<u>LABELS</u>
• Concrete	CONC or PCC
• Hot Mix Asphalt	HMA
• Rock or Stone	ROCK
• Oil & Chip	O & C
• Brick	BRK
• Earth	DIRT

G.1.4 Classification of Structures

• Apartment	APT
• Church	CHURCH
• Barn	B
• Commercial	C
• Garage	G
• Residence	R
• Mobile Home	MH
• School	SCHOOL
• Shed	S

G.1.5 Drainage

- Identify all rivers and creeks by name (include flow arrow).
- Identify all lakes and reservoirs by name.
- Identify culvert types and indicate approximate location of their headwalls. Connect the headwalls and add dimensions (height, width, and type will be included on the map).
- Identify all Paved Ditches by labeling as Paved Ditch.
- Identify Riprap by labeling as Riprap.

H. DELIVERABLES

Upon completion of the field work for a photogrammetric project, the following materials are to be delivered to the Aerial Surveys section:

I. GROUND CONTROL DELIVERABLES

A detailed ground control survey report should be developed that includes all

details of the control survey including information on NGS or IDOT control used. It shall describe the survey methods and control used. It should also include the detailed network adjustment results and the final data processing procedures and a statement of the project datum. Finally, it should contain the final processed coordinates for each survey point, detailed photographs, and field notes for those points.

- All original horizontal and vertical field notes shall be submitted to IDOT, Aerial Surveys section, upon completion of the project.
- Printouts of traverses with the closure information shall be submitted.
- All level notes shall be reduced and adjustments made to all control points.
- New bench marks shall be marked to accommodate third-order standards: Chiseled squares in concrete, etc.

I.1 Ground Control Diagram

Digital maps of the survey network and digital files of the actual coordinates should also be provided with the ground control report.

I.2 Photo Culture Information

Contact prints of the aerial photography marked with photo culture information per [Section G](#).

V. GROUND SURVEYS FOR AIRBORNE LIDAR MAPPING PROJECTS

A. GENERAL

When possible, a well-dispersed checkpoint survey providing a more legitimate assessment of data accuracy throughout the project area for different flight lines is recommended. For dispersed surveys, no two survey checkpoints should be closer than 5,000 feet from the next closest point. If cost and accessibility are an issue, then cluster surveys can be performed. Cluster surveys are typically five points when five land cover categories are being tested, one per category, with a minimum spacing between points.

Clusters should be dispersed following the ASPRS guideline that at least 20% of the points must be in each quadrant. These types of surveys work best with real-time kinematic (RTK) surveys where a base station can be established and five points can be surveyed. RTK is also ideal for establishing intervisible pairs for conventional surveys to establish forest points. No two checkpoints in a single cluster should be within 1,000 feet for the same land cover class.

B. GROUND CONTROL FOR AIRBORNE LIDAR MAPPING

B.1 LiDAR Project Control Layout

In addition to land cover classes, location, and distribution, the surveyor also needs to avoid known pitfalls in selection of checkpoint locations. It is important for the surveyor to understand that the horizontal coordinates of QA/QC checkpoints do not normally match the horizontal coordinates of individual LiDAR pulses. Instead, LiDAR elevations are interpolated from surrounding points to determine the most probable elevation of the LiDAR data at the horizontal coordinates of each QA/QC checkpoint. Interpolation assumptions are reasonably valid only when the following guidelines are followed with checkpoint selection:

- Each checkpoint must be on terrain that is flat or uniformly sloping within 5 meters in all directions from the checkpoint coordinates. Interpolation procedures can fail if the terrain undulates up and down surrounding the checkpoint, or if the slope is curved (concave or convex). Steep slopes should also be avoided for location of checkpoints.
- There should be no breakline within 5 meters of a checkpoint. Breaklines define the edge between two intersecting surfaces with different slopes. This rule can best be explained by using a breakline on a bridge abutment as an example of where checkpoints should not be located. Interpolation of LiDAR elevations around a bridge abutment would normally include a point on top of the bridge deck and another point over the side of the bridge, perhaps near water level 10 feet lower; interpolating between these two elevations (even if both LiDAR elevations were perfect) would erroneously show that the LiDAR data had an elevation error of 5 feet.

- Similarly, checkpoints, even on flat terrain, should avoid logs, tree stumps, rock piles, or other elevated features that could be mapped by LiDAR pulses within 5 meter of a QA/QC checkpoint.
- For survey of checkpoints to be used for horizontal accuracy assessments, surveyors should avoid selecting checkpoints with a high probability of being obscured when mapped with LiDAR (or imagery). Because clearly defined point features are required, horizontal checkpoints are commonly surveyed on corners of paint stripes on asphalt. Such points should not be located under trees (in parking lots) for example, because the black/white intensity variations will not be visible.
- Given the checkpoint site requirements, the checkpoint pre-selection cannot be determined strictly from the office, but left up to the field surveyor to ensure proper validation points. Flexibility must be given to the surveyor as field conditions, including accessibility, are unknown. The surveyor must use the guidance above to plan where checkpoints are likely to be located, but then must make the final decisions in the field, ensuring points are well-spaced, have the correct number of land cover categories, and avoid the pitfalls identified above.

B.1.1 Constraints on Control Placements

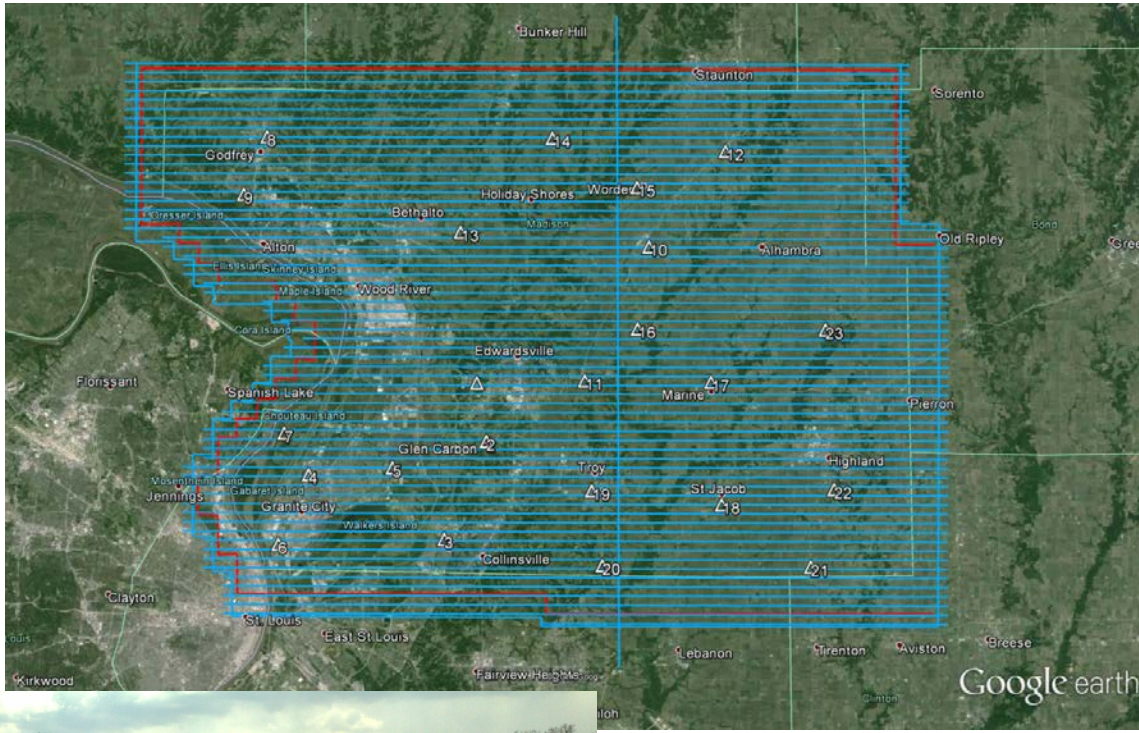

B.1.2 Distribution and Selection Criteria for Quality Points

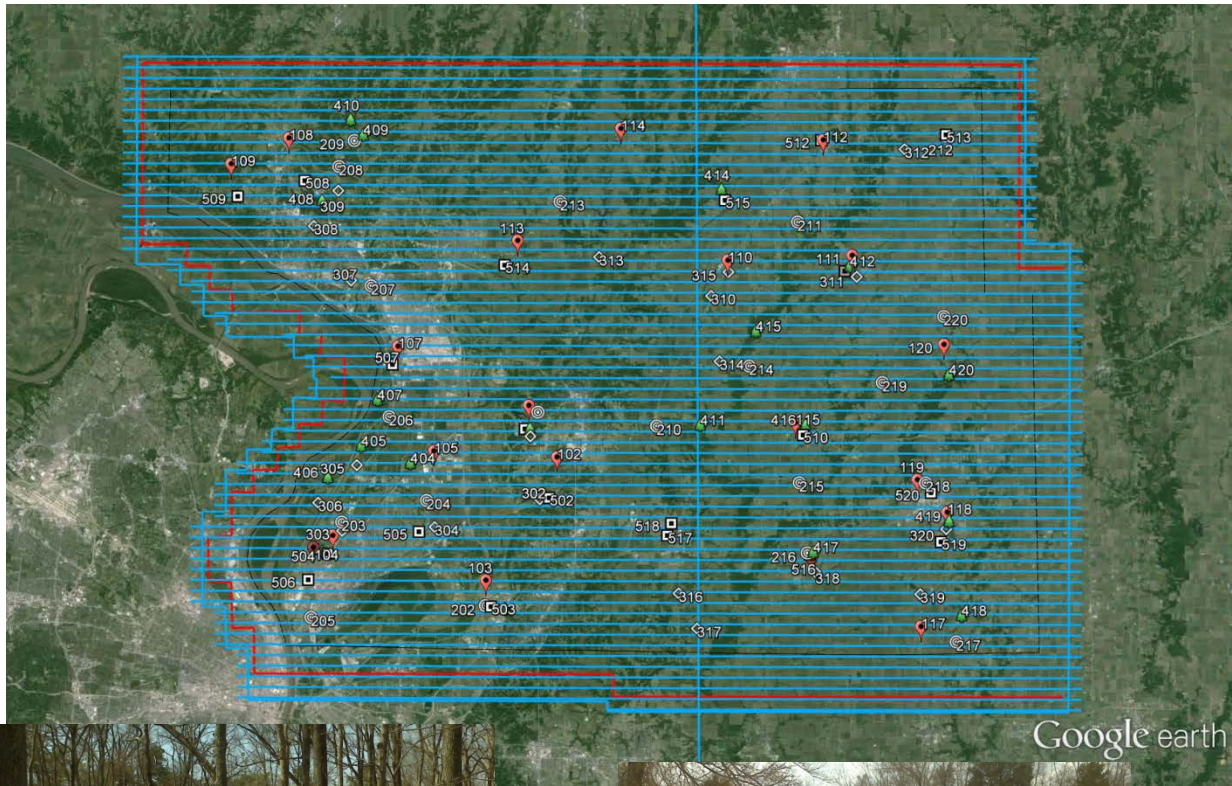

Wooded QC Points – 400s



High Grass QC Points – 200s



Urban QC Points – 500s



Brush QC Points – 300s



Bare Earth Short Grass QC Points – 100s

C. ACCURACY TESTING OF AIRBORNE LIDAR MAPPING

This Section discusses the accuracy testing of LiDAR-derived contour maps and DTM surfaces. Accuracy testing is done to make sure the data resulting from the photogrammetric process correctly reflects the true ground conditions. Three different tests can be performed: 1) Planimetric, 2) Contour, and 3) FEMA Accuracy Testing.

C.1 Testing Planimetry Generated by LiDARgrammetry

LiDAR intensity images in combination with the elevation data can be used to create a pseudo-stereo pair, which then allows a photogrammetric system operator to “see” in 3D and use this technique to better determine the location of ground features. This technique is often defined as LiDARgrammetry. Horizontal testing falls under the same ASPRS guidelines for planimetric maps compiled with thirteen map scales ranging from 1:100 to 1:250,000. Although these standards are intended to primarily pertain to planimetric data compiled from stereo photogrammetry, they are equally relevant to planimetric maps produced from digital orthophotos, ortho-rectified radar imagery (ORI), interferometric synthetic aperture radar (IFSAR), or breaklines compiled from LiDAR, including intensity imagery, using LiDARgrammetry.

C.2 Testing DTM and Contours

A base line will need to be established as for planimetric testing. A profile can be read along this line at points where a contour crosses the base line. The same base line is to be established in the field and a profile of it obtained following third-order leveling procedures. A profile comparison is then run to determine the accuracy of the contour values and location.

C.3 FEMA Accuracy Testing

NSSDA uses the root mean square error (RMSE) to estimate both horizontal and vertical accuracy of the DTM. RMSE is the square root of the average of the set of squared differences between dataset coordinate values and coordinate values from an independent source of higher accuracy for identical points. If those differences are normally distributed and average zero, 95 percent of any sufficiently large sample should be less than 1.96 times the RMSE. Therefore, 15-centimeter RMSE is often referred to as "30-centimeter accuracy at the 95-percent confidence level." Following that convention, the vertical accuracy of any digital elevation model (DEM) is defined as 1.96 times the RMSE of linearly

interpolated elevations in the DEM, as compared with known elevations from high-accuracy test points. DTMs should have a maximum RMSE of 15 centimeters, which is roughly equivalent to 1-foot accuracy. The Contractor must field-verify the vertical accuracy of this DTM to ensure that the 15-centimeter RMSE requirement is satisfied for all major vegetation categories that predominate within the floodplain being studied. The Contractor must separately evaluate and report on the DTM accuracy for the main categories of ground cover in the study area. For example:

- a) Bare-earth and low grass (plowed fields, lawns, golf courses)
- b) High grass and crops (hay fields, corn fields, wheat fields)
- c) Brush lands and low trees (chaparrals, mesquite, mangrove swamps)
- d) Fully covered by trees (hardwoods, evergreens, mixed forests)
- e) Urban areas (high, dense manmade structures)

Testing shall evenly distribute sample points throughout each category area being evaluated and not group the sample points in a small subarea.

The RMSE calculated from a sample of test points will not be the RMSE of the DTM. The calculated value may be higher, or it may be lower, than that of the DTM. Confidence in the calculated value increases with the number of test points. If the errors (lack of accuracy) associated with the DTM are normally distributed and unbiased, the confidence in the calculated RMSE can be determined as a function of sample size. Similarly, the sample RMSE necessary to obtain 95-percent confidence that the DEM RMSE is less than 15 centimeters can also be determined as a function of sample size.

For each major vegetation category, the contractor must test a sample of points and show the test points have an RMSE less than:

$$RMSE_{sample} \leq 15 \sqrt{\frac{(n-1) - 2.326\sqrt{n-1}}{n}}$$

where “n” is the number of test points in the sample.

A minimum selection of 20 test points for each major vegetation category should be identified. Therefore, a minimum of 60 test points must be selected for three (minimum) major vegetation categories, 80 test points for four major categories, and so on.

VI. APPENDICES

A. REFERENCES

ASPRS Standards, Guidelines, and Best Practices:

Standards (Draft 2014)

<http://www.asprs.org/PAD-Division/Map-Accuracy-Standards-Working-Group.html>

Guidelines

[ASPRS Guidelines Vertical Accuracy Reporting for LiDAR Data](#)

[Draft Guidelines for In Situ Metric Camera Calibration](#) (under development)

[DRAFT ASPRS Guidelines Horizontal Accuracy Reporting for LiDAR Data](#)

Federal Emergency Management Agency (FEMA)

Quality Control / Quality Assurance

<http://floodmaps.fema.gov/default.asp>

Federal Highway Administration (FHWA)

Aerial Surveying - Formerly Federal-Aid Policy Guide G 6012.5 Chapter 6

<http://www.fhwa.dot.gov/design/g601205.cfm>

Federal Geographic Data Committee (FGDC)

<http://www.fgdc.gov/standards/projects/FGDC-standards-projects/accuracy/part3/chapter3>, Portable Document File; PDF; 78K.

<http://www.fgdc.gov/standards/fgdc-endorsed-external-standards/index.html>

(includes standards for JPG, GeoTiff, etc.)

[Content Standard for Digital Geospatial Metadata](#) (version 2.0)

[Spatial Data Transfer Standard \(SDTS\)](#), Parts 1-4

[SDTS Part 7: Computer-Aided Design and Drafting \(CADD\) Profile](#)

[Geospatial Positioning Accuracy Standards, Part 1: Reporting Methodology](#)

[Geospatial Positioning Accuracy Standards, Part 2: Standards for Geodetic Networks](#)

[Geospatial Positioning Accuracy Standards, Part 3: National Standard for Spatial Data Accuracy](#)

[Geospatial Positioning Accuracy Standards, Part 4: Architecture, Engineering, Construction, and Facilities Management](#)

[Content Standard for Digital Orthoimagery](#)

[Content Standard for Digital Geospatial Metadata: Extensions for Remote Sensing Metadata](#)

Michigan Department of Transportation (MDOT)

<http://mdotcf.state.mi.us/public/design/surveymanual/>

U.S. Army Corp of Engineers (USACE) (2014 – still in progress)

http://www.mapps.org/resource/collection/DC6E171F-93D8-41FD-AF6E-AEDBB829867A/CHAPTER_2_Photoqrammetry_and_Metric_Remote_Sensing_June_2013.docx

U.S. Geological Survey (USGS)

<http://pubs.usgs.gov/tm/11b4/>

<http://calval.cr.usgs.gov/past-activities/digaerial/usgs-digital-aerial-type-certification/>

<http://calval.cr.usgs.gov/mews/usgs-announces-no-usgs-digital-camera-certification-requirement/>

B. DEFINITIONS

Definitions of some of the common terms used in Geospatial data are listed below:

2D: Two-dimensional. Typically referring to data that has been mapped to a plane such as a map, plan view, or profile.

2.5D: Two and a half dimensional. This typically refers to the situation where a horizontal coordinate system and vertical coordinate system are separated. Generally, in this case, there is one elevation point for a given XY coordinate. Generally most DTMs are 2.5D.

3D: Three-dimensional. In a 3D Cartesian coordinate system (XYZ), there can be multiple Z values at any given XY coordinate.

Aerial laser scan (ALS): Laser scans that are captured from an aerial platform such as an airplane or helicopter.

Analytical Control: The photo control that is developed by analytical aerotriangulation procedures to supplement field control.

Breaklines: Map lines consisting of "XYZ" data points that define linear terrain features that have a uniform slope on either side of the line.

Contact Print: A one-to-one scale print from the aerial negative. The size of this photo is 9" x 9" (228 mm x 228 mm).

Contour: An imaginary line on the ground, all points of which are at the same elevation.

Conventional Control Point: A photo control point that is located by ground survey procedures.

Consolidated Vertical Accuracy: A verification of vertical accuracy for several types of ground cover, which consists of bare, open ground, and other types of land cover.

Cross section: A 2D planar slice of the 3D point cloud.

Culture: Features of the terrain that have been constructed by man.

Decimation: A method of lowering point density in a point cloud.

Density: The number of points per unit area, can also be expressed as the average distance between points in a point cloud.

Design Mapping: Detailed map usually at a scale of 1:600 or 1:500. Vertical relief data is provided to an accuracy to create one-foot or 0.25-meter contour intervals.

Digital Terrain Modeling (DTM): A process for developing a mathematical model of the existing terrain from collected elevation data that is referenced to a coordinate system.

Digital Surface Model (DSM): A Digital Elevation Model (DEM) that has not had surface features removed; vegetation and structures are preserved.

Endlap: The amount by which one photograph covers the same area as covered by the successive photograph along the flight strip. To be suitable for mapping, this amount shall be between 55 and 65%.

Field of View (FOV): The angular extent within which objects are measurable by a device such as an optical instrument without user intervention.

First Return: For a given emitted pulse, it is the first reflected signal that is detected by a 3D imaging system, time of flight (TOF) type, for a given sampling position, that is, azimuth and elevation angle.

Flight Strip: A succession of aerial photographs taken along a single flight line.

Fundamental Vertical Accuracy: A verification of vertical accuracy using only ground control check points in a location on bare, open ground with a high probability of LiDAR sensor detection.

Global Navigation Satellite System (GNSS): A satellite system with global coverage that provides autonomous geo-spatial positioning. Includes the United States' GPS system, Russia's GLONASS, and will include China's COMPASS and Europe's Galileo.

Global Positioning System (GPS): A GNSS system put into use by the United States.

Grid: A point cloud that has been reduced by assigning points into equally distributed cells, typically used as a form of DEM generation.

Ground: Used to describe the physical ground surface with any occluding material removed, such as vegetation and structures.

Horizontal Picture Point (HPT): A photo-identifiable horizontal control point that is horizontally positioned by a field survey.

Intensity: The quantity of laser energy measured at the scanner after light is reflected and returned from a surface. Typically scaled from 0 to 1, 0 to 255, or 0 to 65535.

LAS: A binary file format that has been specifically developed by the American Society for Photogrammetry and Remote Sensing (ASPRS) to improve efficiency and compatibility of working with LiDAR data between software packages. Current version: 1.4.

Last Return: For a given emitted pulse, it is the last reflected signal that is detected by a 3D imaging system, time of flight (TOF) type, for a given sampling position, that is, azimuth and elevation angle.

LiDAR: Light Detection and Ranging, a method of measuring the flight time of a beam of light to calculate range.

Location Mapping: A broad-base map at a scale of 1:2,400 or 1:2,500. The vertical relief data is provided to an accuracy to create five-foot, or 1.5-meter, contour intervals.

Mass Points: A series of "XYZ" data points read on a predetermined grid pattern. The grid pattern spacing is determined by the terrain characteristics. On steep slope areas the pattern must be more closely spaced, whereas, in flat terrain the grid pattern can have a larger spacing.

Photo Control Point: A photo-identifiable point identified on a photograph and having a horizontal and/or vertical position. A series of photo control points provides for the scaling and leveling control for the photogrammetric process.

Photo Identifiable: A point or feature that is identifiable on both the aerial photograph and the ground.

Photo Index: The photo index is a reduced-scale copy of the project aerial photography. It consists of a photographic copy of the composite of all the contact prints laid out by flight strips showing the relationship of all the photos in the project.

Planimetric Features: Those features appearing on a map that represent natural features and cultural features. Natural features include rivers, lakes, mountains, valleys, forests, marshes, wetlands, etc. Cultural features include cities, farms, transportation routes, public utilities, and facilities, etc.

Occlusions: Areas within a point cloud that are void of measurements due to objects blocking the scanners' line-of-sight.

Pits: Refers to artificial points captured below the ground surface.

Point Cloud: A collection of data points in 3D object space (frequently in the hundreds of thousands); for example, as obtained using a 3D-imaging system.

Point Spacing: Elevation or Z values at evenly spaced grid intervals in the horizontal or X and Y direction. In airborne LiDAR, the nominal post-spacing is defined as the typical separation distance between points.

Post Control: Post control consists of photo identifying horizontal and vertical picture points after the photography has been obtained.

Quality Control Point (QP): A point that is used as a vertical check on the photogrammetric process. It is a field-surveyed point.

Root Mean Square Error (RMSE): An indicator of precision by measuring the differences of an estimated or modeled object to the values of the physically observed object.

Reflectance: A measure of how much light is reflected off a surface compared to how much initially hit the surface.

Side Lap: The amount of overlap between two or more parallel flight lines. For mapping projects, this amount should be a minimum of 30%.

Supplemental Vertical Accuracy: A verification of vertical accuracy over ground cover that does not consist of bare, open ground.

Stereo Model: The three-dimensional image formed by two successive overlapping photographs.

Target: An artificial symmetrical pattern that is placed over a control point before aerial photos are taken. Targets are used as horizontal and/or vertical control points. Also called a "panel".

Triangulated Irregular Network (TIN): A type of DTM created by generating triangles to connect points that are irregularly spaced. The three points that form each triangle are used to create a plane that is used for interpolation (typically for elevation) between the points.

Tie Point: A photo control point developed and used in the analytical triangulation process that ties adjacent photographs together. The analytical aerotriangulation process develops XYZ values for each selected pass point.

Vertical Picture Point (VPT): A vertical control point that is photo identifiable and has been vertically positioned by a field survey.

Voids: Areas within a point cloud which were not well-detailed, typically due to blocking of the scanner line-of-sight.

XYZRGBI: Any combination of these letters may be used to define a scanner file format, represented by X, Y, and Z point coordinates; (R)ed, (G)reen, (B)lue color values assigned to the point; and (I)ntensity value assigned to the point.

CHAPTER SEVEN
CADASTRAL SURVEYS (LAND SURVEYS)

BUREAU OF DESIGN AND ENVIRONMENT
SURVEY MANUAL

May 2015

CHAPTER SEVEN

CADASTRAL SURVEYS (LAND SURVEYS)

Table of Contents

	Page
I. INTRODUCTION.....	7-1
A. General	7-1
II. DEFINITIONS	7-2
A. Land Surveying	7-2
B. Right-of-Way Surveys	7-2
III. RESPONSIBILITY OF SURVEYOR.....	7-2
IV. SURVEYING SERVICE LIMITATIONS.....	7-3
V. U.S. PUBLIC LAND SURVEYS	7-3
A. U.S. Rectangular System	7-3
B. Principal Meridians	7-4
B.1 The Second Principal Meridian	7-4
B.2 The Third Principal Meridian	7-4
B.3 The Fourth Principal Meridian.....	7-4
C. Townships.....	7-5
D. Federal Instructions	7-5
VI. PERPETUATION OF U.S. PUBLIC LAND SURVEY MONUMENTS	7-5
A. Illinois Compiled Statues	7-5
B. The Land Survey Monuments Act	7-6
C. Professional Regulation	7-7
VII. PRESERVATION OF MONUMENTS.....	7-8
VIII. SURVEY TIES TO EXISTING MONUMENTS	7-9
IX. ACCURACY OF FIELD WORK	7-10
X. ENTRY ON LANDS TO MAKE SURVEY	7-10
XI. RIGHT-OF-WAY MARKERS	7-12
XII. PERMANENT SURVEY MARKERS AND PERMANENT SURVEY TIES	7-12
 FIGURES	
Principle Meridians and Base Lines of Illinois and Surrounding States (Figure 7.1).....	7-14
Generalized Diagram of the Rectangular System of Surveys (Figure 7.2)	7-15
Township Sections and Corners (Figure 7.3).....	7-16
System of Rectangular Surveys (Figure 7.4)	7-17
Subdivision by Protraction (Figure 7.5)	7-18

Monument Record Examples (Figure 7.6a and 7.6b) 7-19, 7-20
Monument Record Example (Figure 7.7).....7-21
Monument Record Example (Figure 7.8).....7-22
Monument Record Example (Figure 7.9)..... 7-23
Concrete Marker (Figure 7.10)7-24
Concrete Reference Markers (Figure 7.11).....7-25

CHAPTER SEVEN

CADASTRAL SURVEYS

(LAND SURVEYS)

I. INTRODUCTION

A. GENERAL

Land surveying involves the laying off or the measurement of lengths and directions of lines forming the boundaries of land or real property. The Department requires land surveys for one or more of the following purposes:

1. To secure the necessary data for writing legal descriptions and for determining the area of designated tracts of land.
2. To re-establish the boundaries of a tract of land for which a survey has previously been made, and for which the description is known.
3. To subdivide a tract of land into two or more smaller units in accordance with a definite plan which determines the size, shape, and location of the units.

Whenever an owner conveys real estate to another party, it is necessary to know and identify the location and boundaries of the land conveyed within acceptable limits of certainty. Land acquired for highway improvements changes ownership from private owners to the State of Illinois. Private property owners thus become the neighbors of the newly constructed highway facilities. The maintenance of good relationships with these neighbors is a prime concern of the Department. Well-established boundary practices are the basic philosophies on which this section is based.

The Department's policy is that no right-of-way acquisition will result in a boundary dispute and that, as the consequence of the construction of a highway project, no pre-existing legal landmarks should be destroyed or obliterated. In the event of inadvertent or neglectful destruction or obliteration of public or private survey monuments, the Department will take steps to make corrections without undue delay.

II. DEFINITIONS

A. LAND SURVEYING

Land Surveying is the art and science of (1) re-establishing U.S. Public Land Surveys and land boundaries based on documents of record and historical evidence; (2) planning, designing, and establishing property boundaries; and (3) certifying surveys as required by statute or local ordinance such as subdivision plats, registered land surveys, judicial surveys, and space delineation.

B. RIGHT-OF-WAY SURVEYS

Right-of-Way Surveys are land surveys performed to accurately locate and describe the land or rights to be taken for a transportation facility. The right-of-way may be acquired in fee or as an easement.

III. RESPONSIBILITY OF SURVEYOR

The Illinois Compiled Statutes describe the practice of land surveying and Illinois Professional Land Surveyors performing work for the Department must be aware of their duties and responsibilities as per [225 ILCS 330/1](#), *et seq.* and [55 ILCS 125/0.01](#), *et seq.* Surveyors have no judicial authority to resolve boundary disputes. They do have the legal authority to locate, on the ground, the limits of property ownership according to their interpretation of a valid written description. Surveyors gather and evaluate evidence relative to boundary locations and may testify as to their judgment based on their data findings. Land surveyors have no authority to subdivide land. This authority is with the property owners who may portion off their property in accordance with statutory requirements and local zoning ordinances. The land surveyors act as the agents of the owners, make their surveys, prepare the plats and legal descriptions, and certify to the conditions under which their work was completed.

"TITLE 68: PROFESSIONS AND OCCUPATIONS CHAPTER VII: DEPARTMENT OF FINANCIAL AND PROFESSIONAL REGULATION SUBCHAPTER b: PROFESSIONS AND OCCUPATIONS PART 1270 ILLINOIS PROFESSIONAL LAND SURVEYOR ACT OF 1989 [SECTION 1270.56 MINIMUM STANDARDS OF PRACTICE](#)" controls the practice of Land Surveying in the State of Illinois.

In retracing the old and established lines, the land surveyor must follow the footsteps of the original surveyor. It is therefore essential that they know the historical background of land surveys in the area of their work.

Right-of-Way Surveys will be performed with the same degree of care and with the same principles, equipment, and procedures and under the same statutory common laws as are used for the performance of land surveys by private surveying practitioners for the general public.

IV. SURVEYING SERVICE LIMITATIONS

This Department is not in the business of Land Surveying, meaning that no land surveying services will be provided to any private owner as an inducement to sign an instrument of conveyance. During right-of-way negotiations, property owners occasionally request that their property be surveyed in its entirety, showing the area of taking as well as that of the remainder. The policy of the Department is to survey and monument the area of takings only. No land surveying services will be provided to any private owner. To survey a property in its entirety would only be justified if it is in the interest of this Department, that is, if the remainder must be established with certainty for appraising purposes. In such instances, no monument shall be set by the surveyor and no certified plat should be recorded.

At times, it is required that the right-of-way lines be staked either to satisfy the property owners during the negotiation process or to delineate the taking for jury viewing in a condemnation proceeding. This work, because of its preliminary nature, does not require setting of permanent monuments and is not considered a bona fide survey.

When a right-of-way taking causes the loss of physical monuments marking the apparent corners of property, new monuments of equal or better quality shall be set at the intersection of the property line and the right-of-way by or under the direction of an Illinois Professional Land Surveyor. A parcel plat shall be prepared, in all such instances, and recorded with the Recorder of Deeds or Registrar of Titles in the county in which the property is located.

V. U.S. PUBLIC LAND SURVEYS

A. U.S. RECTANGULAR SYSTEM

The basic division of the land in Illinois is the U.S. Public Land Survey System, also known as the [U.S. Rectangular System](#). The objective of this system was to establish and monument on the ground legal land divisions for the purpose of describing and conveying of the public domain under the general land laws of the United States. The rectangular system is basically a grid system under which the

land is divided uniformly and referenced to two fixed lines, one at right angles to the other. One is a north-south line and is called the principal meridian. The other line, an east-west line, is called the base line.

B. PRINCIPAL MERIDIANS

The land in Illinois was surveyed by government surveyors using three different principal meridians:

B.1 The Second Principal Meridian

The Second Principal Meridian was established in 1805 to control the surveys in Indiana and a portion of Illinois. The Second Principal Meridian starts at the confluence of Little Blue River with the Ohio River and runs north to the northern boundary of Indiana. Its geographic location is 85 degrees, 27 minutes, and 21 seconds longitude west of Greenwich. The base line is an east-west line at 38 degrees, 28 minutes, and 14 seconds latitude. It commences at Diamond Island in the Ohio River and runs due west to the Mississippi River. For practical reasons, its extension is the base line for the Third Principal Meridian.

B.2 The Third Principal Meridian

The Third Principal Meridian controls the major portion of Illinois. This meridian passes through the approximate center of the state. It was established in 1805 as a line running true north from the point of confluence of the Ohio and Mississippi Rivers. Its location is 89 degrees, 08 minutes, and 54 seconds longitude west of Greenwich, England. The base line is an east-west line intersecting the Third Principal Meridian at a point near Centralia at 38 degrees, 28 minutes, and 27 seconds latitude.

B.3 The Fourth Principal Meridian

The Fourth Principal Meridian was established in 1815 to control the lands located between the Illinois and Mississippi Rivers. It begins at a point near Beardstown and extends northward. It is an extension of a line straight north from the mouth of the Illinois River near Grafton. The longitudinal reading of this line is 90 degrees, 27 minutes, and 11 seconds west of Greenwich. See [Figure 7.1, page 7-14](#).

The base line for the Fourth Principal Meridian runs straight west from the beginning of this meridian near Beardstown. The geographical location of this line is 40 degrees, 0 minutes, and 50 seconds north of the equator. The Fourth Principal Meridian has a second base line used for describing land in Wisconsin and parts of Minnesota. This base line coincides with the Illinois-Wisconsin border.

C. TOWNSHIPS

After placement of the principal meridians and base lines, the government surveyors established the grids of townships, whose sides are six miles east and west and six miles north and south. Subsequently, the townships were subdivided by the deputy surveyors into 36 sections of one mile square, according to instructions by the Surveyor General (See [Figures 7.2 and 7.3, page 7-15 and 7-16](#)). The monuments set by these government surveyors are now to a great extent lost or obliterated. Their locations, however, mark the legal boundaries of all the lands and the restoration of these monuments and determination of the original township and section lines is the core of all land surveying activities. See [Figures 7.4 and 7.5, pages 7-17 and 7-18](#), respectively.

D. FEDERAL INSTRUCTIONS

The land in Illinois was surveyed by the government surveyors between the years of 1805 and 1855. The major part of the work was done between 1815 and 1835. The first written instructions to the deputy surveyors for subdividing townships were issued in 1815 by Edward Tiffin, Surveyor General. The Land Surveyor in Illinois must be thoroughly familiar with these instructions. A valuable source of information is a publication by the Illinois Professional Land Surveyors Association entitled "Federal Instructions for Surveyors of the Public Lands from 1785 to 1843." Also essential to the Land Surveyor is the pamphlet by the U.S. Department of the Interior, Bureau of Land Management, entitled "[Restoration of Lost or Obliterated Corners and Subdivision of Sections](#)." Copies of this pamphlet and Tiffin's Instructions are available to the Surveyors of the Department from the Central Bureau of Land Acquisition (CBLA) upon request.

VI. PERPETUATION OF U.S. PUBLIC LAND SURVEY MONUMENTS

A. ILLINOIS COMPILED STATUTES

The Land Survey Monuments Act ([765 ILCS 220/0.01 to 11, et seq.](#)) provides for the perpetuation of Land Survey Monuments.

Based on these statutes, a professional land surveyor is required to file monument records with the County Recorder of Deeds or Registrar of Titles in the county in which the survey is made, using public land survey monuments as control corners. The Act also requires the filing of monument records after establishing, reestablishing, restoring,

or rehabilitating a public land survey monument, except when a monument record is already on file with the Recorder of Deeds or Registrar of Titles and the monument is found at the location described.

B. THE LAND SURVEY MONUMENTS ACT

The Land Survey Monuments Act makes any person, including the responsible official of any agency of State, County, or Local government who willfully and knowingly violates any of its provisions guilty of a "Class A" misdemeanor. The Department requires that all work performed in regard to Land Surveying and preparation of statutory plats (Parcel Plats and Plats of Highways) be in full compliance with this Act. In order to clarify ambiguities, to assure uniformity of interpretation and to provide for acceptable standards of practice and professional ethics for Land Surveyors in State employment and those retained on a contractual basis, the following guidelines are applicable:

- No survey shall be completed and no plat shall be acceptable which uses a section corner or quarter corner as a control corner for which no monument record is on file with the Recorder of Deeds or Registrar of Titles or for which such a monument record has not been satisfactorily prepared and submitted together with the plat ready for filing.
- If a survey is controlled by a reestablished monument placed by the surveyor at the location of a lost corner in accordance with lawfully prescribed methods, it shall be mandatory that location ties to all monuments used in reestablishing the lost corner be provided as part of the monument record.

In certain instances this will require preparation and filing of more than one monument record document, such as:

- If it is required that a survey show the direction of a section line or the angle subtended between a section line and the centerline or survey line, it is necessary that two monuments be used to establish the section line with certainty. The ties to both monuments shall be noted on the monument record and placed on file according to the Act.
- Restoration of lost or obliterated corners must be by or under the direct supervision of an Illinois Professional Land Surveyor.

- A corner shall not be declared lost until every means has been exercised that might aid in identifying its true original position.
- In no event may a non-licensed surveyor declare a monument lost, nor may unsupervised field searches for corners be made that would possibly destroy the corner accessories and original marks that would have provided evidence for the position of a corner.

Every section corner and quarter section corner or their positions are Public Land Survey monuments subject to this Act. The recordation of other points resulting from the subdivision of sections (aliquot corners) is not required. It is, however, encouraged by this Department to do so whenever possible in order to facilitate the maintenance of a tight network of monument records.

C. PROFESSIONAL REGULATION

Special instructions for the implementation of the Land Survey Monuments Act issued by the Department of Professional Regulation are adopted by this Department:

- The monument record shall be recorded at the time of recording the survey if the survey is placed on record, but no later than 40 days after the survey is completed.
- The document shall consist of one or more individual sheets measuring 8.5 inches by 11 inches, not permanently bound, and not a continuous form.
- The document shall be printed in black ink, typewritten, or computer generated, in at least 10-point type, and shall have clarity suitable for microfilming and reproducing.
- The document shall be on white paper of not less than 20-pound weight, and shall have a clean margin of at least one half-inch border on the top, the bottom, and each side. See [Figures 7.6a and 7.6b, on pages 7-19, 7-20](#).
- The first page of the document shall contain a blank space, measuring at least 3 inches by 5 inches, in the upper right-hand corner.
- The document shall not have any attachment stapled, or otherwise affixed, to any page.

- There shall be no more than four monuments shown on each Record and all monuments must be for a common section.
- The surveyor may show geodetic position or other information at his/her option, providing it does not detract from the clarity of the requirements of the monument record.
- The drawing shall be oriented with north toward the top of the form. See Figures 7.7, 7.8, and 7.9 on pages 7-21, 7-22, and 7-23.

VII. PRESERVATION OF MONUMENTS

Section 9-104 of the Highway Code ([605 ILCS 5/9-104](#) *et seq.*) provides that:

“In grading highways, corner stones marking sectional or other corners shall not be disturbed, except to lower such stones so that they will not rise above the surface of the highway. If a corner stone is covered to a depth greater than 12 inches, or is covered with a highway surface material other than road oil, the location of the corner stone shall be preserved by setting a suitable monument over the stone which shall be level with the highway surface or by setting at least 3 offset monuments in locations where they will not be disturbed. When any corner stone is lowered or when a monument is set over a stone or when offset monuments are set, it shall be done in the presence of and under the supervision of an Illinois Professional Land Surveyor who shall record the type and location of the reference monuments with respect to the corner stone in the office of the recorder in the county in which such a stone is located.”

Pursuant to the Land Survey Monuments Act, ([765 ILCS 220/0.01](#) *et seq.*) surveyors have a duty to preserve and restore monuments.

To comply with the provisions of this Act, it is the policy of the Department that if in the design of a highway improvement, it is determined that a U.S. Public Land Survey Monument will be affected by construction operations, the Designer shall prepare Special Provisions to be included in the contract, which will provide for the construction and payment for all such monuments and markers. The Special Provisions shall clearly stipulate that setting of the monuments and markers are to be done under the supervision

of either a contractor-provided or District-provided Illinois Professional Land Surveyor. The Special Provisions shall also require that the attendant monument records be prepared and filed in accordance with [765 ILCS 220/7](#).

VIII. SURVEY TIES TO EXISTING MONUMENTS

[765 ILCS 205/9](#), in part, states that when a new highway is laid out or widened (does not mean widening of pavement), and when an existing highway is vacated, a plat must be prepared by or under the direction of an Illinois Professional Land Surveyor, which must be filed with the Office of the County Recorder or Registrar of Titles. The plat must show reference ties to legal subdivisions of the land known by established corners or adequate existing records.

In rural areas, known and established corners are those of the existing public land survey system. In urban areas, this system is normally further subdivided into city blocks and lots, into commercial and industrial tracts, into residential subdivisions, streets, roads, and highways.

The surveyor must take great care to reference their survey lines to the existing survey schemes. The surveyor must note found monuments, recover obliterated corners, and re-establish lost corners to provide adequate reference for control of the boundary lines involved.

It is, therefore, incumbent upon the District Chief of Plats and Plans, the Illinois Professional Land Surveyor for the Department, to make an extensive study of a project prior to the beginning of the survey work. They should determine which monuments will be used as control corners of the survey, and which monuments are existing, obliterated, or lost. They should also decide which corners are to be reestablished and take steps to do so with the assistance of the survey party prior to establishing the survey line. If the locations of the control monuments are resolved prior to the commencement of the route survey, much time will be saved in later efforts to establish their positions.

The District Chief of Plats and Plans must also take whatever action is necessary to ensure that the basic survey lines and centerlines are established with expected accuracy and that boundary lines are measured and referenced to the survey line with the same degree of certainty. The success of this phase of work is based entirely upon the lead-time available to the land surveyor in preparing the preliminary studies, the diligence used in this preparation, and finally upon the cooperation between the route surveyors and the professional land surveyors in the districts.

In the search for existing control monuments, the District Chief of Plats and Plans has access to copies of the original U.S. Public Land Survey field notes and the plats of record from the State Archives. Photocopies will be provided upon request. In addition, the Monumentation Recordation Act ([765 ILCS 220/1 et seq.](#)) provides for a good source of information at the County Recorder of Deeds or Registrar of Titles Office.

The office of a private land surveyor who has worked in the area or who has prepared and filed subdivision plats which are affected by the right-of-way taking is the most fruitful source of information in matters of survey monuments and control corners, whether relative to the Public Land Survey System or private subdivision. Professional land surveyors are required by law “to cooperate in matters of maps, field notes, and other pertinent records” ([765 ILCS 205/9](#)) with their fellow professional surveyors. The District Chief of Plats and Plans in searching for survey control monuments must take positive steps to contact local surveying practitioners to gather needed data. Requests for this information must be made in writing.

The letter may be submitted in person or may be mailed after a telephone contact. Non-cooperation by private practitioners in regard to this matter must be brought to the attention of CBLA and the Illinois Department of Professional Regulation for proper action.

The Department is likewise committed to cooperate in providing data to private surveying practitioners.

IX. ACCURACY OF FIELD WORK

Field work must conform with the Accuracy Standards as described in [Chapter 4](#) of this Manual.

There is a separate manual that addresses Land Acquisition Policies and Procedures. However, that manual does not set forth standards or specifications with respect to measurement “accuracy standards” that a professional surveyor must achieve to meet the needs of the Department. Likewise, the State of Illinois Minimum Standards for performing boundary surveys details many requirements the Professional Surveyor must meet, but also does not dictate a set of accuracy standards that a professional must know in advance in order to properly plan and execute a survey. In Illinois, at present, the only standard that requires Professional Surveyors to perform to a specific accuracy standard is the [2011 ALTA/ACSM Land Title Survey Standards](#).

X. ENTRY ON LANDS TO MAKE SURVEY

Section 4-503 of the Highway Code ([605 ILCS 5/4-503](#)) provides for entry on land to make a survey as follows:

“For the purpose of making subsurface soil surveys, preliminary surveys and determinations of the amount and extent of such land, rights or other property required, the Department, or any county, by its offices, agents or employees, after written notice to the known owners and occupants, if any, may enter upon the lands or waters of any person, but subject to responsibility for all damages which shall be occasioned thereby.”

Members of a survey party are usually the first representatives of this Department who have contact with property owners or tenants along the route of a proposed improvement. The impressions they leave will reflect on this Department and enhance or jeopardize the right-of-way acquisition activities that follow.

Prior to entering any private property, the surveyor in charge shall give notice to the known owners and occupants requesting permission to enter and briefly explain the purpose, nature, and approximate duration of the proposed work (see [Exhibit LA 239](#) for Entry Upon Lands sample letter). The surveyor, however, refrains from discussing any plans or policies that might be misconstrued. All personal contacts are carefully and accurately recorded for future reference. As a minimum, the record includes the names of persons contacted, identifying them as owners or occupants, the date and time of conversation, and a brief synopsis of the conversation. During such contacts the surveyor never displays an impolite attitude nor is an indication made to the owner that in fact the surveyor has a lawful right to enter.

While surveyors have a right to enter, such entry is subject to liability for all damages caused. The written notification includes assurance that the Department guarantees reimbursement for any actual damages to the property or crops that are caused by the entry on and work of surveying personnel on the property. The Department believes that its statutory powers to conduct surveys and subsoil testing include the right to collect information on the environmental condition of future right-of-way, i.e., hazardous substances.

In order to restore obliterated or lost corners of the U.S. Public Land Survey System, it is sometimes necessary that surveyors enter upon land that may be several miles from the proposed highway improvements. Even though no right-of-way takings are involved in connection with such entries, the owners are nevertheless to be treated with the same courtesy as stated above.

Statutory provisions for general entry upon property by surveyors are also contained in the Illinois Professional Surveyor Act of 1989 ([225 ILCS 330/45](#)) as follows:

"A Professional Land Surveyor, or persons under his direct supervision, together with his survey party, who, in the course of making a survey, finds it necessary to go upon the land of a party or parties other than the one for whom the survey is being made is not liable as a trespasser and is liable only for any actual damage done to the land or property."

The surveyor or a member of the survey party shall maintain a record of all damages incurred to be given to the district Bureau of Program Development/Land Acquisition (DLA) engineer/manager upon completion of the survey. The record comments on the following as applicable: crop damage (kind, extent, estimated amount) and damage to improvements such as fences, fence posts, gates, trees, shrubs, etc.

XI. RIGHT-OF-WAY MARKERS

Right-of-way markers are used to delineate the extent of State highway right-of-way for operational purposes such as mowing, landscaping, and general highway maintenance. In accordance with specifications contained in the [Design and Environment Manual](#), they are placed at discontinuities in the right-of-way line.

Right-of-way markers are not survey markers and their location is not to be construed to mark the property lines. They are part of the structural facility of a highway and have no more nor less bearing on the property lines than the pavement or fence lines in place. Irons pins set to mark the state right-of-way boundary shall not be removed when setting right-of-way markers. A common distance for markers to be set is 6 to 12 inches inside the right-of-way boundary.

To avoid ambiguity and property line disputes, right-of-way markers shall not be placed at the points where property lines or property fences between adjacent owners intersect the right-of-way lines. Right-of-way markers at such locations could mistakenly be interpreted to mark the property lines between adjoining properties.

XII. PERMANENT SURVEY MARKERS AND PERMANENT SURVEY TIES

Permanent survey markers are used to delineate the centerline of a project and to establish State-owned permanent land survey control monuments on the ground. Such markers should be set at all points that geometrically define the survey line or the centerline of a highway location, i.e., points of intersection (P.I.), if accessible and within the right-of-way, points on curve (P.O.C.), points of curvature (P.C.), points of tangency (P.T.), and points on tangent (P.O.T.). The spacing of the markers should be close enough that at least two are visible from any one monument (backsight and foresight) thus providing for location and directional control of the survey line.

On certain types of projects or under certain conditions of the terrain of a project, the placement of permanent survey markers at the location of the control points may not be practical. In these situations, reference markers should be set near the right-of-way lines to perpetuate the location of the control points.

The location of the control points should be established at the time of the original survey. The markers will be set during construction in accordance with the construction plans and under the direction of an Illinois Professional Land Surveyor.

To provide for this work, the Designer shall prepare special provisions to be included in the contract that will call for the construction and payment for permanent survey markers and permanent survey ties.

See Figures [7.10](#) and [7.11](#), pages [7-24](#) and [7-25](#), for examples of permanent markers.

PRINCIPAL MERIDIANS AND BASE LINES OF ILLINOIS AND SURROUNDING STATES

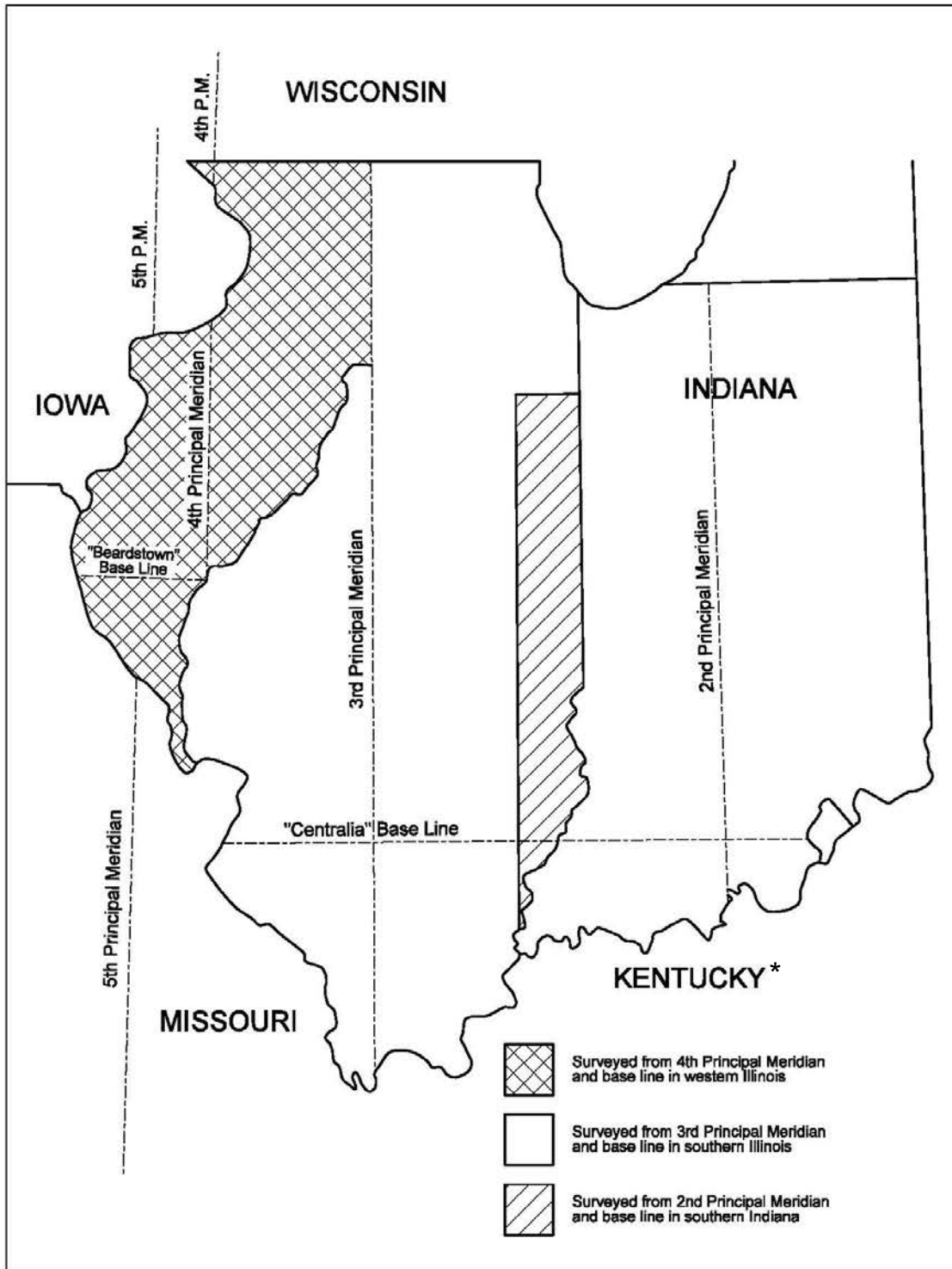

*Except for the Jackson Purchase (1818), 8 counties were established on their own Principal Meridian and Base Line.

Figure 7.1

GENERALIZED DIAGRAM OF THE RECTANGULAR SYSTEM OF SURVEYS

TOWNSHIP GRID

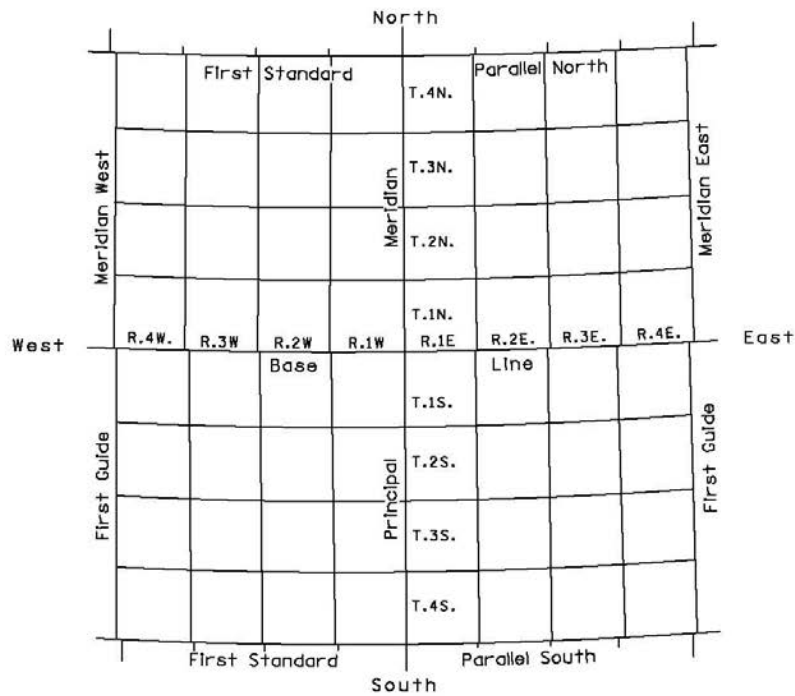

TOWNSHIP 2 SOUTH, RANGE 3 WEST

6	5	4	3	2	1
7	8	9	10	11	12
18	17	16	15	14	13
19	20	21	22	23	24
30	29	28	27	26	25
31	32	33	34	35	36

SECTION 14

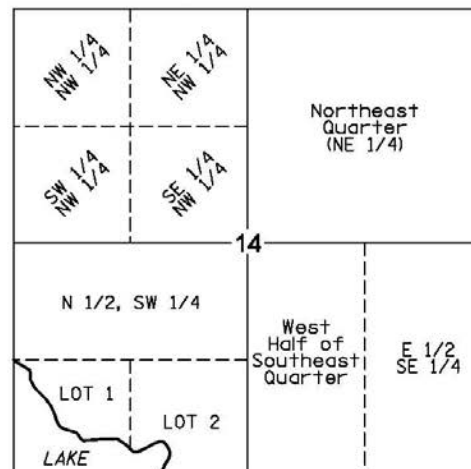

Figure 7.2

From original field notes dated 1805
of Township 2 North, Range 12 West
Second Principal Meridian

6	59 5	58 4	57 3	56 2	55 1
60	50	51	52	53	54
7	40 8	42 9	44 10	46 11	49 12
39	41	43	45	47	48
18	38 17	37 16	36 15	35 14	34 13
28	29	30	31	32	33
19	18 20	20 21	22 22	24 23	27 24
17	19	21	23	25	26
30	16 29	12 28	9 27	6 26	3 25
15	14	11	8	5	2
31	13 32	10 33	7 34	4 35	1 36

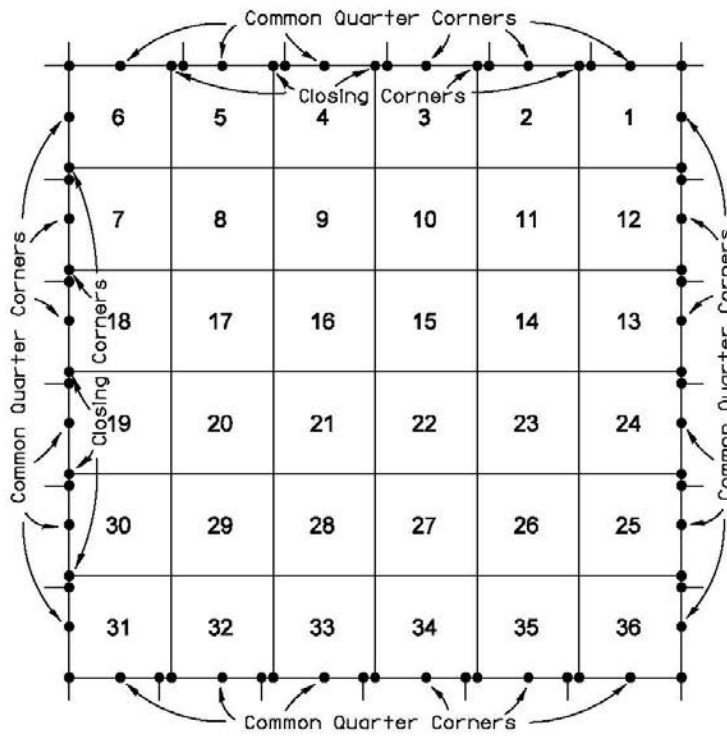

Figure 7.3

SYSTEM OF RECTANGULAR SURVEYS

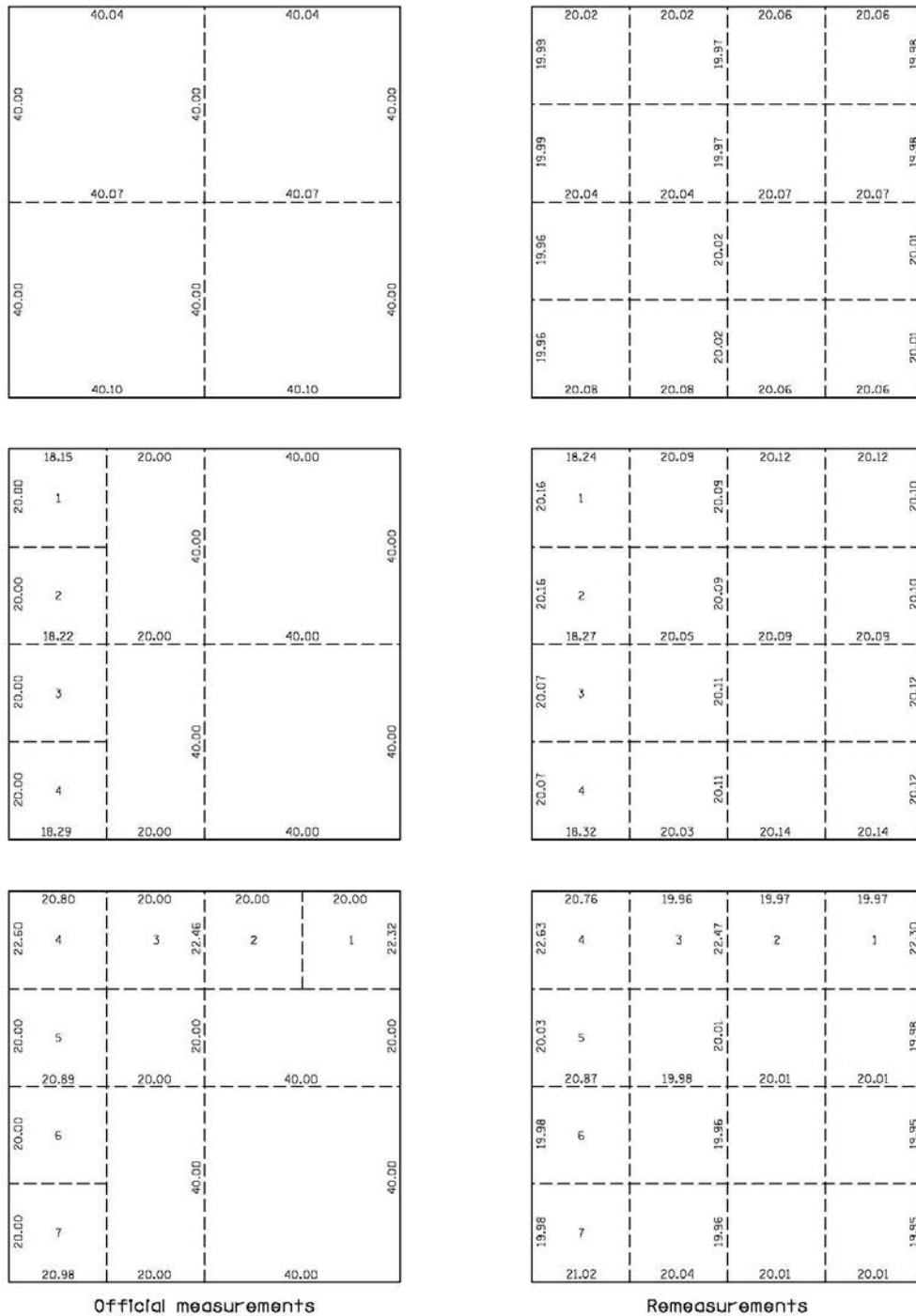
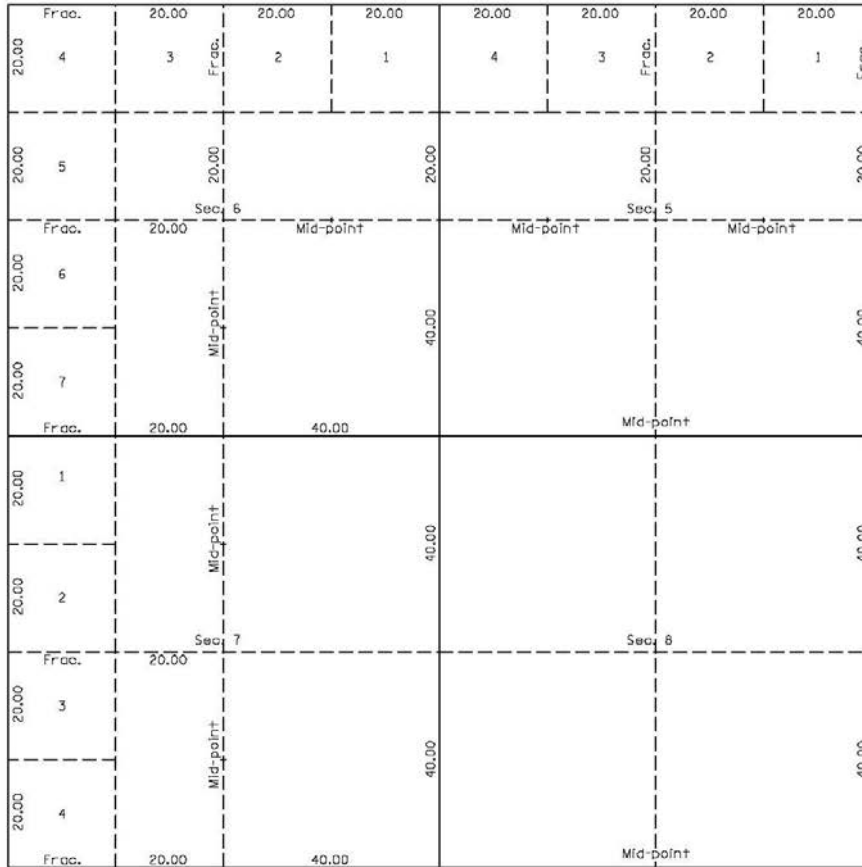

Figure 7.4

The above examples of subdivision by survey show the relation of the official measurements and calculated distances to the remeasurements, and indicate the proportional distribution of the differences.

SUBDIVISION BY PROTRACTION



Showing normal subdivision of sections

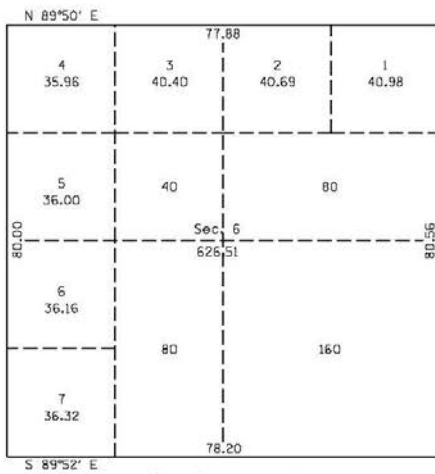

Showing areas

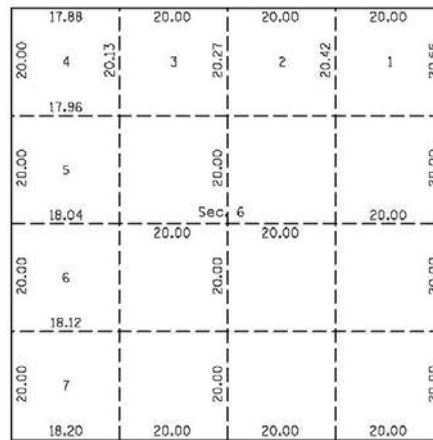

Showing calculated distances

Figure 7.5

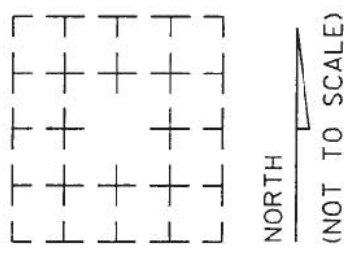
<p>"MONUMENT RECORD" LAND SURVEY MONUMENTS SITUATED IN: SECTION _____, TWP _____ RANGE _____, _____ P.M. _____, COUNTY, IL</p> <div style="text-align: center;">  </div>	<p>SPACE RESERVED FOR RECORDING OFFICER</p>
<p><u>RECOVERY TIE DRAWING</u> (SHOW MONUMENT DESCRIPTION, ACCESSORIES & KNOWN HISTORY AT EACH RECORD CORNER WITH TIES).</p>	
<p>ROUTE _____ SECTION _____ JOB NO. _____</p>	<p>I, _____, HEREBY CERTIFY THAT THIS DOCUMENT WAS PREPARED UNDER MY DIRECTION IN ACCORDANCE WITH THE LAND SURVEY MONUMENT ACT CHAPTER 765 ILCS 220.</p> <p>IL PLS NO. _____ DATE _____</p>

(SEAL)

SHEET 1 OF ____

Figure 7.6a

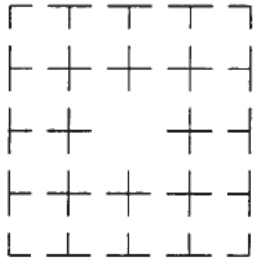

"MONUMENT RECORD"
 SECTION _____ TWP _____
 RANGE _____, _____ P.M.
 _____ COUNTY, IL

ROUTE _____
 SECTION _____
 JOB NO. _____

SHEET _____ OF _____

Figure 7.6b

"MONUMENT RECORD"

OF
LAND SURVEY MONUMENTS
SITUATED IN SECTION 16
TOWNSHIP 36 NORTH
RANGE 8 EAST, 3RD P.M.
KENDALL COUNTY, IL

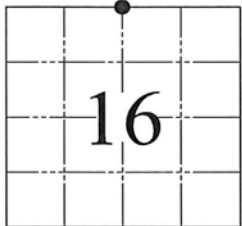

This space for Recorder's use only
RECOVERY TIE DRAWING
(NOT TO SCALE)

MONUMENT DESCRIPTION AND REMARKS:
ILLINOIS STATE PLANE COORDINATE
SYSTEM, EAST ZONE NAD 83 (2007)
N 1799340.4510
E 986413.3480

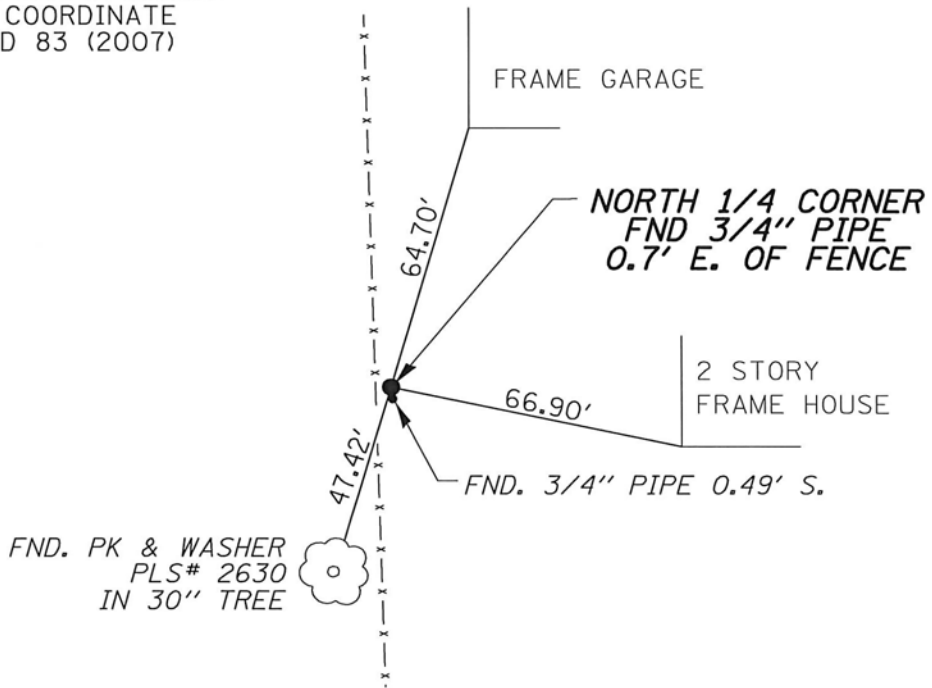

**Illinois Department
of Transportation**

Division of Highways

ROUTE FAU 379
SECTION (118)N
JOB NO. R-93-009-14

SHEET 1 OF 3

STATE OF ILLINOIS)
COUNTY OF LEE) SS

I, COVENTINE FIDIS, HEREBY CERTIFY THAT THIS DOCUMENT WAS PREPARED UNDER MY DIRECTION IN ACCORDANCE WITH THE PUBLIC ACT 765 ILCS 220 AND THE ABOVE DATA IS GIVEN UNDER MY HAND AND SEAL THIS 5th DAY OF MAY, 2014 A.D.

ILLINOIS PROFESSIONAL LAND SURVEYOR NO. 2159
MY LICENSE EXPIRES 11/30/14
PROFESSIONAL DESIGN FIRM NO. 184-003192

Figure 7.7

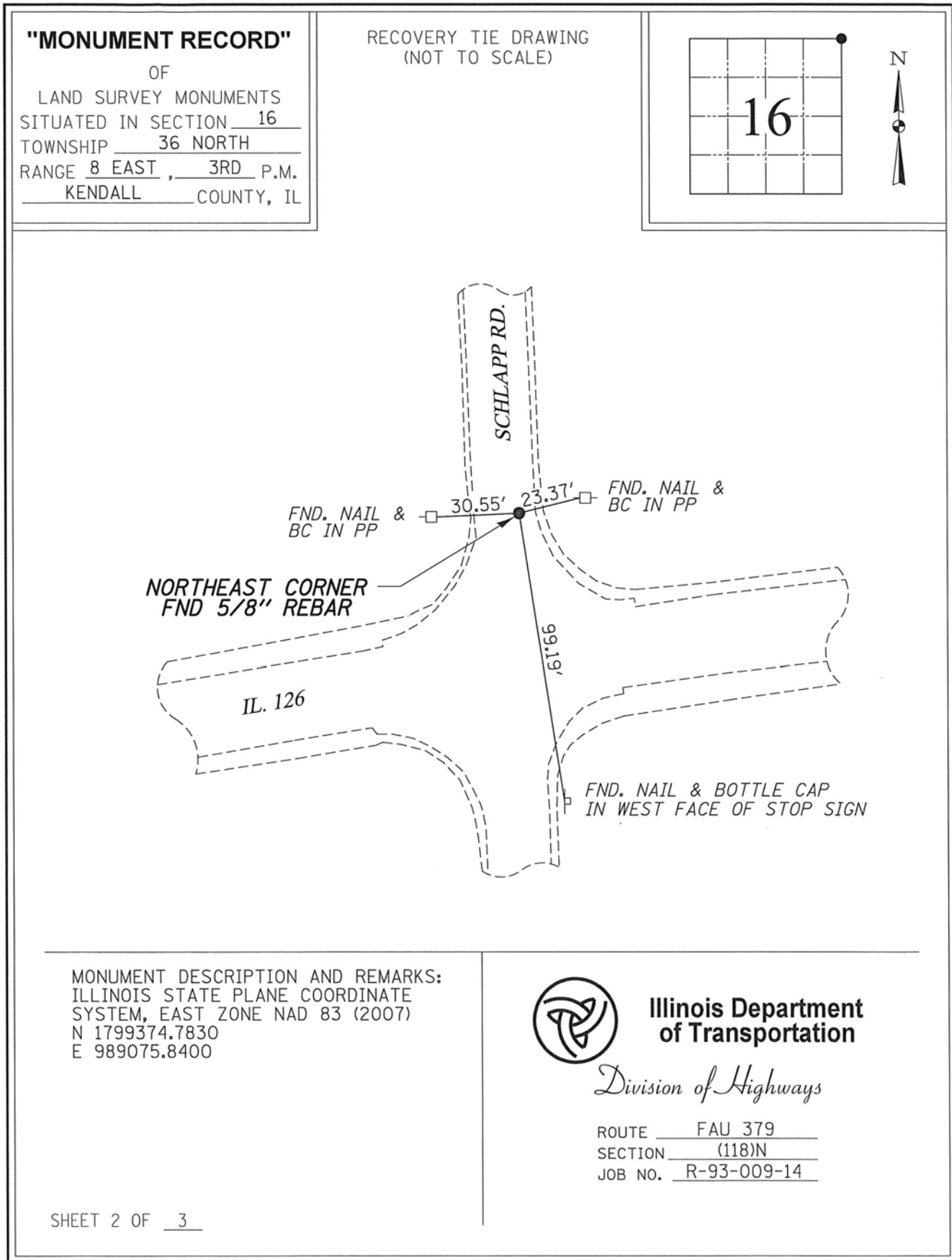

210007.4

Figure 7.8

"MONUMENT RECORD"

OF
LAND SURVEY MONUMENTS
SITUATED IN SECTION 16
TOWNSHIP 36 NORTH
RANGE 8 EAST, 3RD P.M.
KENDALL COUNTY, IL

RECOVERY TIE DRAWING
(NOT TO SCALE)

FND. PK NAIL IN
WEST FACE OF
POWER POLE

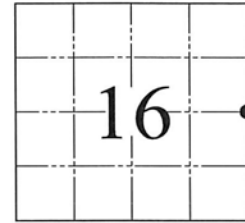

SCHLAPP RD.

126.65'

EAST 1/4 CORNER
FND 1" PIPE 0.4'
BELOW GRADE & 2'
EAST OF C/L ROAD

FND. PK ON TOP 12" CMP

23.92'

FND 5/8" REBAR

20.57'

74.42'

FND. PK ON TOP 15" CMP

MONUMENT DESCRIPTION AND REMARKS:
ILLINOIS STATE PLANE COORDINATE
SYSTEM, EAST ZONE NAD 83 (2007)
N 1796729.8080
E 989163.0820



**Illinois Department
of Transportation**

Division of Highways

ROUTE FAU 379
SECTION (118)N
JOB NO. R-93-009-14

SHEET 3 OF 3

210007.4

Figure 7.9

CONCRETE MARKER (U.S. PUBLIC LAND SURVEY MONUMENT)

METHOD OF INSTALLATION

- SET MARKER IF NO USPLS MONUMENT PRESENT.
- SET MARKER IF USPLS MONUMENT IS FIVE FEET OR MORE BELOW FINISHED GRADE.
- UNDER PAVEMENT AND SURFACE COURSE SET TOP AT SUBGRADE ELEVATION.
- UNDER SHOULDERS SET 3" BELOW FINISHED GRADE.
- IN MEDIAN AND OUTSIDE ROADWAY LIMITS SET TOP AT FINISHED GRADE.
- IN CULTIVATED FIELD SET TWO FEET OR MORE BELOW GROUND SURFACE.
- IN FENCE LINE OR PROTECTED AREA SET TOP AT GROUND LEVEL.
- USE CLASS X CONCRETE.

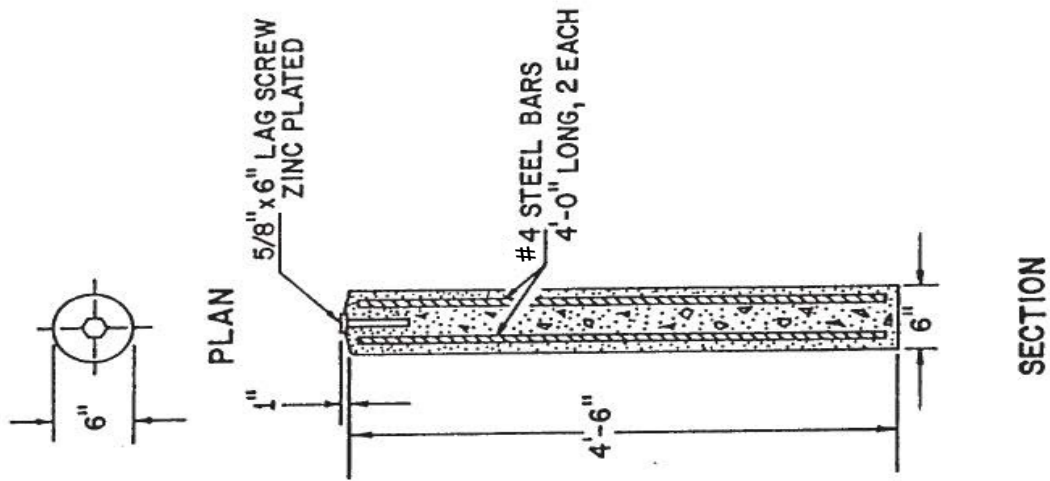

R.L. SPRECHER - DIST. #2

Figure 7.10

CONCRETE REFERENCE MARKERS (U.S. PUBLIC LAND SURVEY MONUMENT)

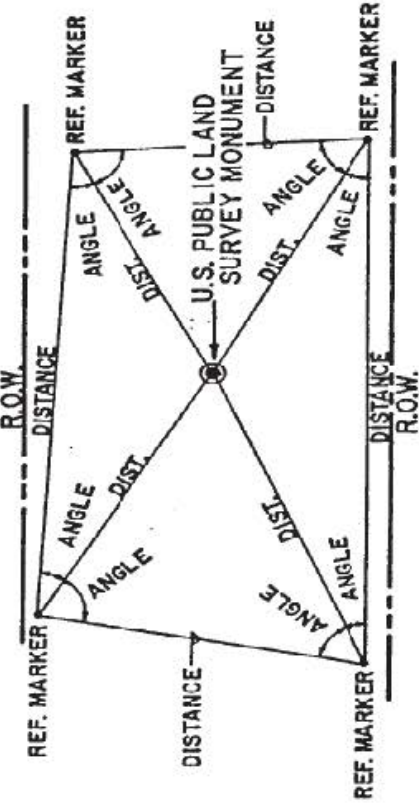

METHOD OF REFERENCING USPLS MONUMENTS WITHIN R.O.W. AND ON PRIVATE PROPERTY

- USE INSTRUMENT TIES TO NEARBY LAND MARKS (STEEPLES, TOWERS, ETC.)
- IN CULTIVATED FIELD SET TWO FEET OR MORE BELOW GROUND SURFACE.
- IN FENCE LINE OR PROTECTED AREA SET TOP AT GROUND LEVEL.
- CLASS X CONCRETE SHALL BE USED THROUGHOUT.

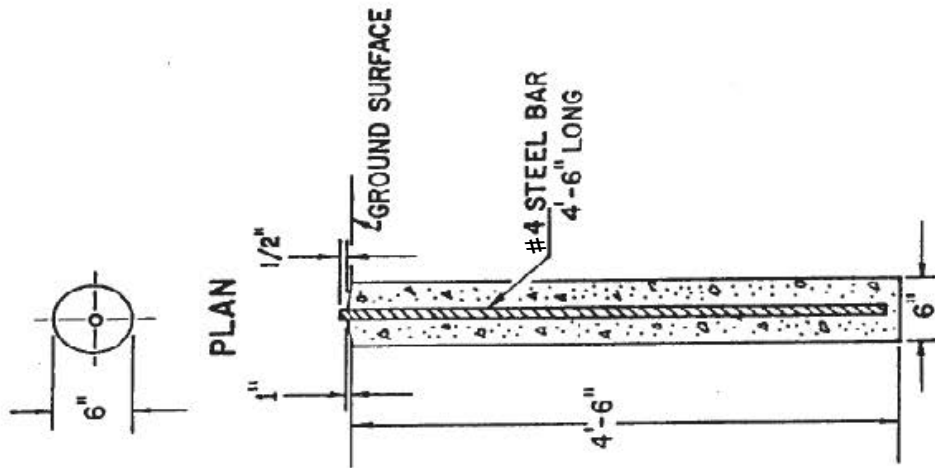

SECTION

R. L. SPRECHER - DIST. # 2

Figure 7.11

CHAPTER EIGHT
TERRESTRIAL LASER SCANNING

BUREAU OF DESIGN AND ENVIRONMENT
SURVEY MANUAL

May 2015

CHAPTER EIGHT

TERRESTRIAL LASER SCANNING

Table of Contents

	Page
I. INTRODUCTION	8-1
A. Laser Scanning	8-1
A.1 Current Instrumentation.....	8-1
A.1.1 Time of Flight	8-2
A.1.2 Phased Based	8-2
A.2 Point Cloud.....	8-2
A.3 Virtual Surveying	8-3
A.4 Guidelines for Use	8-4
A.4.1 Safety	8-4
A.4.2 Efficiency	8-4
A.5 Limitations of the Technology	8-4
II. STATIC TERRESTRIAL LASER SCANNING	8-5
A. Equipment	8-5
A.1 Accuracy	8-5
A.2 Errors/Calibration/Maintenance	8-5
B. Control Points	8-6
B.1 Accuracy	8-6
B.2 Spatial Geometry	8-6
B.3 Target Material Type and Surface	8-7
C. Data Capture.....	8-7
C.1 Planning.....	8-7
C.2 Overlapping Clouds.....	8-7
C.3 Point Cloud Density.....	8-7
D. Data Processing.....	8-8
D.1 Registration.....	8-8
III. MOBILE TERRESTRIAL LASER (MTL) SCANNING	8-8
A. Equipment	8-8
A.1 Accuracy	8-9
A.2 Errors/Calibration/Maintenance	8-9
B. Control/Validation Points	8-10
B.1 Accuracy	8-10
B.2 Spatial Geometry	8-10
B.3 Target Material Type and Surface	8-10
C. Data Capture.....	8-11
C.1 Planning.....	8-11
C.2 Overlapping Clouds.....	8-11
C.3 Point Cloud Density.....	8-11
C.4 GPS/GNSS Coverage And PDOP.....	8-11
D. Data Processing.....	8-12
D.1 Geometric Correction of Point Clouds	8-12
IV. DELIVERABLES	8-12
A. Raw Point Clouds	8-13

A.1 Noise in the Point Cloud	8-13
A.2 Point Density of Point Cloud	8-13
A.3 Accuracy Testing	8-13
A.4 File Format/Structure	8-14
B. Discrete Survey Points	8-14
C. CAD Entities	8-14
C.1 Lines and Polylines.....	8-14
C.2 Digital Terrain Models.....	8-14
C.3 Primitive 3D Models.....	8-14
D. Photographs/Videos	8-14
V. APPENDICES.....	8-15
A. NCHRP REPORT 748	8-15
B. Caltrans Survey Manual 2011.....	8-15

CHAPTER EIGHT

TERRESTRIAL LASER SCANNING

I. INTRODUCTION

A. LASER SCANNING

Laser Scanning, sometimes called 3D Laser Scanning, is the most recent significant addition to the surveying and engineering community's remote sensing technology. Not since the advent of the Global Positioning System (GPS) has there been such a significant paradigm shift in the way raw field data is collected. In recognition of this significant change in technology, the Department has set forth these standards and specifications knowing full well that the technology is changing and growing almost daily. Therefore, as in other technology-dependent processes, more emphasis in these guidelines is placed on the results as opposed to the process.

The instrumentation and process of data collection using Laser Scanning is based on the technology of LiDAR. LiDAR is an acronym derived from the term Light Detection and Ranging, a technology used for the remote collection/sensing of topographic information. Various platforms are used to acquire the scanning data. These platforms are divided into Aerial or Terrestrial, with Terrestrial being further classified as either Static or Mobile. Aerial scanning was one of the earliest applications, and is still the more widely used, of the platforms. Aerial scanning requires airborne vehicles, while Terrestrial Laser Scanning data is collected while on the surface of the earth. The term LiDAR is most commonly used when dealing with aerial acquisition, while Laser Scanning commonly refers to the process of collecting data through terrestrial acquisition

Static Terrestrial Laser Scanning is performed from stationary positions, such as from a tripod or lift assembly. Mobile Terrestrial Laser (MTL) scanning is collected from mobile devices while traveling along the project boundaries. Terrestrial scanning has been in development for many years, with static terrestrial laser scanning being the most accurate of the platforms.

A.1 Current Instrumentation

Scanning equipment is used to remotely obtain information on a surface of interest (e.g., the face of an object, building, roadway surface, sidewalk surface, etc.). The scanning instrument is aimed at a surface of interest and emits a light beam. After

the beam strikes the surface, the instrument measures the return signal of the reflected light. By combining the relative angles of the light beam as it is emitted from the instrument, and determining the distance to the surface using the return signal, a relative XYZ coordinate location of the point on the surface can be obtained.

When the amplitude of the returning signal is measured, a value of the reflectivity of the surface can also be assigned. The process is repeated over and over in a pattern, resulting in many points representing the surface.

A.1.1 Time of Flight

There are predominantly two basic types of scanning equipment used for survey work. The “Time of Flight” instrument uses the speed of light to calculate the distance from the instrument to the surface. Time of Flight has two advantages over the second type (Phased Based). It is capable of greater distance measurement and noise reduction. The disadvantages of Time of Flight are decreased speed and accuracy; however, advances are rapidly improving the technology.

A.1.2 Phased Based

The second type of scanning equipment is the “Phased Based” instrument, also called Phase Shift, which depends on the wavelength of the light used to determine the distance from the instrument to the surface. Three disadvantages exist when comparing Phased Based to the Time of Flight system. The first is cycle ambiguity. The laser pulse is shifted to cause a phase cycle of a given length. The distance from the instrument to the surface can be determined accurately anywhere along this length, but the number of phase cycles is uncertain (the instrument is unable to determine if the distance is for example 0.235, 1.235, or 2.235 times the phase cycle). A second disadvantage is the system has trouble operating in bright sunlight. Finally, Phased Based has a shorter operating range. Recent advances in technology have reduced these disadvantages drastically, however. Phased Based does have an advantage in that it is usually faster and more accurate than Time of Flight technology.

A.2 Point Cloud

With laser scanning, millions of points are collected and combined to represent the surface of interest. This virtual surface appears in software visually as a “cloud of points.” Point Cloud is a common name used by many vendors and has been

adopted for use by the Department. Unlike points collected by other surveying techniques, the points contain no literal description (such as, point on building, back of curb, or pavement surface) and exist as a mass of unprocessed point data.

A.3 Virtual Surveying

In contrast to scanning technology, conventional survey techniques determine the location of a single discrete point of interest (e.g., the corner of a building, back of curb, intersection of a sidewalk, center of a light standard, etc.). Using the example of a cube, scanning could define each side of the cube with hundreds to thousands of points, whereas conventional surveying techniques would define just the eight corners and likely have a point description associated with each corner.

The development of this technology has impacted the industry in more ways than one. Extremely large raw data files are compiled when compared to conventional survey data, shifting the responsibility for defining what has been located from the field to the office. As in the cube example, conventional survey techniques would define, locate, and describe the eight corners of the cube while in the field. With scanning technology, it now becomes the responsibility of the office technician to visualize the six sides of the cube; produce, pick, or estimate the corners, edges, or sides; and then describe, classify, and compile the information. To aid the office technician, the point data may contain information on the reflectivity of the surface it represented. This information can be color-coded to help identify different materials, colors, or roughness in the surface. The points may also be color-coded based on the actual color from photographs that are taken by the scanning instrument, or other photographs referenced by the software used to process the point cloud.

A single point cloud containing millions of points based on a relative coordinate system (not referenced to project control) may be used to determine the relative location or clearance between objects, such as the low beam of a bridge over pavement, but gives no indication of where the bridge is on the project. To answer the where, the relative coordinate system of the point cloud can be translated and rotated (geo-referenced) to project control. By combining point clouds, surfaces of objects not visible from one point of view can be measured, compared, and analyzed.

A.4 Guidelines for Use

There are many applications and use of the scanning technology. Its use is limited only by the surveyor's imagination. Some primary considerations for use would include safety and efficiency.

A.4.1 Safety

In regard to safety, removal, or reduction of the crew from an unsafe or access-restricted environment is paramount. Examples of such environments would be complicated, limited-access expressways, or confined spaces such as a manhole or underground vault. As a remote sensing technology, laser scanning can remove or reduce the interaction of human beings with unsafe conditions.

A.4.2 Efficiency

In a "Data Rich Environment," such as a bridge, tunnel, or railroad yard where numerous objects/surfaces of interest exist in a small area, the acquisition speed of a laser will far exceed that of a human moving from point to point. Using laser scanning technology on a two-lane rural road with few topographic features would require too many setups to locate relatively few features, making this an improper use of the technology.

A.5 Limitations of the Technology

Scanning technology is based on a clear line-of-sight from instrument to the surface of interest; therefore trees, vegetation, pedestrians, vehicles, or other visual obstructions (not of interest) may reduce or limit its use.

Lighting conditions may influence the type of laser scanner selected for a particular project, as Time of Flight is typically less affected than Phased Based by direct, bright sunlight. As previously noted, the technology is rapidly changing and the impact of bright light is less problematic.

Weather and surface condition is also a primary consideration. Mist, fog, snow, and other weather conditions impact the use of Laser Scanning. Wet, shiny, and other highly reflective surfaces currently limit the use due to saturation, blooming, or other detrimental effects on return signal.

II. STATIC TERRESTRIAL LASER SCANNING

To reduce the obsolescence of this Chapter due to rapid changes in the technology, these guidelines are performance-based rather than procedural, and will be non-vendor or technology-specific. The following procedural guidelines are mandatory but are intended to be generic in nature.

A. EQUIPMENT

The Department does not mandate the manufacturer, brand, or type of equipment used, as long as the accuracy standards are met. Static Terrestrial Laser Scanning is performed with a stationary instrument. The instrument must be kept on a stable platform, such as a tripod or other fixed platform, capable of resisting movement and maintaining the instrument location, rotation, and level within the manufacturer's specifications.

A.1 Accuracy

The accuracy of the equipment must meet or exceed the project positional accuracy requirements for the points of interest for any single point acquired, according to the manufacturer's specifications. Accuracy is determined by many factors. The laser spot size, which increases as the distance from the laser increases, and the calibration of the instrument are factors that can be controlled or anticipated. Both must be considered during the planning and collection of data.

A.2 Errors/Calibration/Maintenance

Systematic equipment errors for static scanning can be classified as:

- Instrument centering, horizontal, and vertical collimation errors.
- Angular resolution (from the angle encoder) errors.
- Distance errors (usually caused by clock accuracy).

The equipment must be calibrated and maintained as per the manufacturer's specifications to remove/reduce systematic errors. A copy of the latest calibration report and the manufacturer's suggested calibration interval must be included in the Survey Report.

B. CONTROL POINTS

Control points are used to combine Point Clouds and Geo-Reference the instrument and/or the corresponding point cloud(s) to the project coordinate system. The accuracy, spatial geometry, shape, and materials used for control are all affected by the type and manufacturer of the equipment. Two general types of control points are generally acceptable. The first is geo-referenced with known project coordinates and usually of a permanent nature. The second is randomly selected points without known project coordinates, used to tie two or more point clouds together, which are usually only temporary.

B.1 Accuracy

Local control must be from an independent source and establish an accuracy level equal to or greater than the accuracy requirements for the Project Points of Interest.

B.2 Spatial Geometry

The location and quantity of control points must provide redundant observations to allow for a “Least Squares Best Fit” adjustment and report the estimated accuracy of the adjustment. (Primary control must meet the Accuracy Standards as specified in [Chapter Four](#) of this Manual.)

With a Dual-Axis Compensated instrument, each setup location requires a minimum of two points to define the coordinate system, and at least one more for redundancy. Without Dual-Axis Compensation, each setup location requires a minimum of three points to define the coordinate system, and at least one more for redundancy. At least two control points (e.g., backsight, check point, etc.) shall be at or near the limits of the scan data to be collected, and at least one point per setup shall be geo-referenced (have the project coordinates determined by an independent source of equal or higher accuracy).

Unless prohibited by safety or access constraints, and approved by the Department, at least three control points shall be distributed between at least three of the four quadrants around the instrument at a distance greater than or equal to the farthest point of interest and have at least a 60-degree angle between them. Additional check points or verification points may be added which do not need to meet this requirement.

B.3 Target Material Type and Surface

Targets used to represent the control points must meet the manufacturer's specifications, or as approved by the Department.

C. DATA CAPTURE

The following procedures must be met before or while observations are made using static terrestrial laser scanning equipment.

C.1 Planning

Prior to conducting field operations, the project site must be reviewed and a plan developed that outlines the safety concerns and procedures to minimize unsafe conditions for the motoring public, pedestrians, and workers. The Safety Plan must take into account the tasks to be performed, site conditions, time of work, and equipment to be used.

C.2 Overlapping Clouds

Scanning technology is based on a line-of-sight to the surface of interest. Adjacent setups may be required where multiple surfaces of the same object are not visible from one location. This is also required where the same surface extends beyond the limits of the instrument. Where adjacent setups exist, there should be at least a 15% overlap of the point clouds between them. At least one common control point shall be used for adjacent setups.

C.3 Point Cloud Density

The Surveyor will be responsible to determine the point density required for each object of interest for the survey. There are multiple factors to be considered when determining the desired point cloud density. The reflective properties (color and type of surface) and angle of incidence to surfaces from the scanner can impact both the functional range of the scanner and the number of points obtained. Darker surfaces, such as fresh bituminous pavement, will yield less overall data than lighter surfaces, such as older bituminous pavement or concrete. Extremely shiny surfaces, such as the top of railroad rails, give virtually no returned signal. It is important to take note of changing conditions on the site and plan your setups accordingly to ensure sufficient density is obtained. The resolution settings on laser scanners currently reference density relative to a vertical wall at a set distance from the scanner.

This will not directly translate to a similar density on a horizontal roadway surface where the angle of incidence is increasing as the distance from the scanner increases. Test setups are recommended to gauge the workable range and point cloud density of the scanner in different environments. (See also "[Point Density of Point Cloud](#)" under [Section IV. Deliverables](#) in this Chapter).

D. DATA PROCESSING

D.1 Registration

Multiple methods and names are used by vendors to combine and/or geo-reference point clouds. One common term is the "registration" of point clouds, which has been adopted by the Department. The registration process must be based on a best fit least squares adjustment that reports the estimated accuracy of the adjustment. The report may be used in whole or in part to report the estimated accuracy of the survey. The adjustment report shall be included in the Survey Report and may not contain residuals for the cloud-to-cloud or cloud-to-fixed control points greater than the accuracy specified for the project points of interest.

III. MOBILE TERRESTRIAL LASER (MTL) SCANNING

A. EQUIPMENT

The Department does not mandate the manufacturer, brand, or type of mobile laser scanning equipment used, as long as accuracy standards are met. Not all Mobile Laser Scanning manufacturers or combinations of equipment/sensors are created equal. Mobile Laser Scanning is performed with a scanning instrument or combination of scanners in motion. The instrument(s) is actually a group of other types of sensors mounted rigidly on a framework that can be transported along the project to collect data.

The typical instrument package includes the scanning instrument(s), an Inertial Measurement Unit (IMU), a Global Positioning System (GPS/GNSS), a Distance Measuring Indicator (DMI, usually an axle or wheel encoder), and a camera(s). The GPS/GNSS, IMU, and DMI work in conjunction with each other to determine the location and trajectory of the equipment.

The equipment must all move as one unit, and each piece must be related spatially to one another (calibrated), including the horizontal and vertical offsets and the angle of the rotational axis for the scanning unit as compared to the sensing axes of the IMU. The location and direction of the emitted laser is then analyzed using the calibration and trajectory to calculate the location of the return signal, and thus the XYZ coordinates of the point on the surface.

A.1 Accuracy

The accuracy of the equipment must meet or exceed positional accuracy requirements for the points of interest for any single point acquired during the project. To ensure that project specifications are met, a Performance Test will be required within or near the project limits. The size of the performance test area will be determined by the Department on a project by project basis. The Project Surveyor shall establish control and check (validation) points as planned for the project. The Department will establish additional validation points at its discretion. All validation points will be withheld from the geo-referenced adjustment to the trajectory or point cloud. The Performance Test results must be submitted to the Department for approval prior to performing the project MTL Scanning.

A.2 Errors/Calibration/Maintenance

Systematic mobile scanning equipment errors can be classified as:

- Laser errors (due to distance or angular determination).
- Positional trajectory errors (due to drift in the IMU).
- Angular misalignment between the laser and IMU axes (bore sight).
- Spatial 3D offset between the laser, IMU, and GPS/GNSS equipment (lever arm).

The equipment must be calibrated and maintained in accordance to the manufacturer's specifications to remove/reduce systematic errors. A copy of the latest calibration report and manufacturer's suggested calibration interval shall be included in the Survey Report. At a minimum, the bore sight calibration should be performed at the beginning and end of the data collection, or per the manufacturer's specifications. The calibration report should include a list of the equipment, the calibration parameters, method used, and estimated accuracies. A sample Calibration Report can be found in the Appendix ([NCHRP 15-44 Guidelines](#)) and should be used unless the Manufacturer's Report is more detailed.

B. CONTROL/VALIDATION POINTS

Control points are used to geo-reference the instrument and/or corresponding point cloud(s) to the project coordinate system. The accuracy, spatial geometry, and the targets used for control are all affected by the type and manufacturer of the equipment.

Validation points may be identical to the control points; however, they are used to verify the accuracy of the point cloud rather than fix its location and must be withheld from the adjustment.

B.1 Accuracy

Local control must come from an independent source and be established at an accuracy level equal to or greater than the accuracy requirements for the points of interest.

B.2 Spatial Geometry

The location and quantity for both control (transformation points) and validation points must provide for the geometric adjustment and accuracy analysis to meet the project's accuracy requirements. Control points shall be located on each side of the scan trajectory within the limits of the point cloud and shall be spaced less than 1,500 feet apart as measured in line with the scan trajectory. Validation points shall likewise be located on each side of the scan trajectory and shall be spaced less than 500 feet apart. Each scan trajectory shall be spaced to ensure a minimum of 20% side overlap of adjacent point clouds. Unless the Department determines the project accuracy requirements can be met with less stringent requirements, or safety concerns preclude, control and validation points shall be established as indicated. Alternate plans for control and validation points must be pre-approved by the Department and analyzed in the Performance Test. The results should be discussed in the Survey Report. Surveys of lower accuracy may use spacing and location for control points as recommended by the Manufacturer, and shall be tested for accuracy using validation points and as indicated in [Chapter 4](#) (Accuracy Standards) of this Manual.

B.3 Target Material Type and Surface

Targets used to represent the control and validation points must meet the equipment manufacturer's specifications, or as directed by the Department.

C. DATA CAPTURE

The following procedures must be met before or while observations are made using MTL Scanning equipment.

C.1 Planning

Prior to setting up field operations, the project site must be reviewed and a plan developed that outlines the safety concerns and procedures to minimize unsafe conditions for the motoring public, pedestrians, and workers. This project Safety Plan must take into account the tasks to be performed, site conditions, time of work, and equipment to be used.

C.2 Overlapping Clouds

Point clouds from adjacent runs should have at least a twenty percent (20%) overlap. A test for common points in the overlap between adjacent point clouds shall be considered a Feature Category, as noted in [Chapter 4](#) (Accuracy Standards) Section V. B. "Root Mean Square Error" of this Manual. Test procedures outlined in Chapter 4 should be followed.

C.3 Point Cloud Density

The Project Surveyor will be responsible to determine the point density required for each object of interest for the survey. But Point Densities will meet the minimum guidelines as depicted in [Table 8.1](#), unless directed otherwise by the Department.

C.4 GPS/GNSS Coverage and PDOP

Global Position System (GPS) and Global Navigation Satellite System (GNSS) coverage and/or visibility, as well as Maximum Position Dilution of Precision (PDOP), should be reviewed and considered prior to making observations. The maximum duration or distance traveled with degraded or lost GPS/GNSS signal shall be less than the ability of the IMU to correct and still meet the project accuracy requirements.

The Survey Report shall include a review of the maximum duration of time and distance traveled with degraded PDOP (greater than 5) or lost GPS/GNSS signal. It shall also include the correction parameters (the variation or drift of the horizontal and vertical position, roll, pitch, and heading) of the IMU.

A statement will be required confirming the correction parameters of the IMU were sufficient to correct for the duration of the degraded or lost GPS/GNSS signal as required to meet the project accuracy requirements.

D. DATA PROCESSING

D.1 Geometric Correction of Point Clouds

Multiple methods (and terms) are used by vendors to correct or adjust the point cloud to better fit the control or transformation points. The most common and preferred method is the adjustment of the raw navigation trajectory of the vehicle. This is performed post-processing where the observed transformation points are input and the trajectory of the vehicle reprocessed or adjusted to best fit the points. The second method is a rigid body translation of the point cloud to fit the control points.

The Geometric Correction and the resulting residuals are to be discussed in the Survey Report.

IV. DELIVERABLES

The “raw data” product created by laser scanning, whether static or mobile, is called the point cloud. Most engineering processes have been slow in adopting or using this product directly for analysis, due in part to the volume of information presented. The volume of information creates very large computer file sizes and subsequent demands for processing speed from the computer, which in turn slows down the analysis. Computer speed, memory, and software have been making great strides that will allow for Point Cloud use, and will likely change the workflow from the current two-dimensional (2D) drawings with an annotated vertical component to the fully integrated, three-dimensional (3D) Computer Aided Drafting and Design (CADD) files.

Currently, deliverables from laser scanning may have information removed and interpreted to provide the same deliverables as the conventional field survey, namely a collection of discrete points converted into 2D, 2-1/2D, or 3D line drawings and Digital Terrain Models (DTMs), also known as Triangulated Irregular Networks (TINs). However, the point cloud is the raw data and will be delivered in a format specified by the Department.

As the Department transitions to 3D design, future deliverables may likely also contain primitive 3D models of the project. The Department will issue addendums or project-specific guidelines and requirements as the deliverables change. Regardless of the final delivery, the raw data is the basis of design and must meet the project accuracy requirements.

A. RAW POINT CLOUDS

A.1 Noise in the Point Cloud

Laser scanning captures points on all surfaces within the distance, surface reflectivity, and/or angle of incidence limits for the system. Points on surfaces such as vegetation, pedestrians, and vehicles not of interest; false points caused by the distortion of the laser signal return caused by reflections; splitting of the return signal, etc., are considered noise and must be removed, “cleaned,” or classified so as not to be used for a DTM, cross sections, profiles, etc., or as the deliverable product. The cleaned point cloud shall also be delivered to the Department.

A.2 Point Density of Point Cloud

The Project Surveyor will be responsible to determine the point density required for each object of the survey. The final location of the objects determined (selected or modeled) and reported must meet the accuracy specified for each category as outlined in [Chapter Four](#) (Accuracy Standards).

The following Table 8.1 depicts guidelines for the suggested minimum point density. The Department will determine specific point densities other than the suggested minimums to meet project requirements when necessary.

Table 8.1

Category	Minimum Points / Square Foot
High-Accuracy Topographic/Planimetric	Greater than 20
Hard Surface Grades/Profiles/DTM	Greater than 10
Low-Accuracy Topographic/Planimetric Soft Surface Grades/Profiles	Greater than 5

A.3 Accuracy Testing

Static Terrestrial Laser Scanning shall be tested as outlined under [Section II](#) of this Chapter for the Control and Registration operations, along with the accuracy standards outlined in [Chapter Four](#) (Accuracy Standards).

Mobile Terrestrial Laser (MTL) Scanning shall be tested as outlined under [Section III](#) of this Chapter for the Control and Geometric Correction operations, along with the accuracy standards outlined in [Chapter Four](#) (Accuracy Standards).

A.4 File Format/Structure

The Department may issue project-specific guidelines when the point cloud is to be used, based on the software to be used. Without any stated requirement, the file(s) should be saved in one of the common file formats (e.g., ASPRS-LAS, ASTM-E-57, etc.) and supported by most of the scanning equipment vendors' software.

B. DISCRETE SURVEY POINTS

The most common deliverable from static or mobile scanning is a group of single point (XYZ) coordinates using a description code to identify what the point represents. The point code must follow the Department's standards. In lieu of specific guidelines issued for the project, the following may be used: XYZI or XYZIRGB files in ASCII, CSV, XML, LAS, or ASTM E57 3D Imaging Data Exchange Format (E2761).

C. CAD ENTITIES

The following deliverables shall comply with the Department's CAD Standards.

C.1 Lines and Polylines

Lines and Polylines created from the discrete points selected from the point cloud.

C.2 Digital Terrain Models

DTMs or TINs will require project-specific guidelines, discussing the size and density of the nodes (points or vertices). The point cloud must be cleaned and all noise removed prior to the creation of the DTM. (See [Section A.1](#) above.)

C.3 Primitive 3D Models

Project-specific guidelines will likely be issued discussing the items to be modeled and the software to be used if this is requested as a deliverable.

D. PHOTOGRAPHS/VIDEOS

Project-specific guidelines will be issued discussing the file format and/or the software to be used if this is requested as a deliverable. Without any stated requirement, the file(s) should be saved in a common file format (e.g., JPEG, TIFF, WMV).

V. APPENDICES

- A. [“National Cooperative Highway Research Program \(NCHRP\) 15-44 Guidelines”](#)
- B. [“Caltrans Survey Manual 2011”](#)

CHAPTER NINE
HYDROGRAPHIC/BATHYMETRIC SURVEYS

BUREAU OF DESIGN AND ENVIRONMENT
SURVEY MANUAL

May 2015

CHAPTER NINE

HYDROGRAPHIC/BATHYMETRIC SURVEYS

Table of Contents

	Page
I. INTRODUCTION	9-1
A. Hydrographic/Bathymetric Surveys	9-1
II. BOTTOM MATERIAL.....	9-3
A. Underwater Bottom Materials.....	9-3
A.1 Hard Bottom	9-3
A.2 Soft Bottom	9-3
A.3 Unconsolidated Bottom	9-4
III. CONVENTIONAL BATHYMETRIC SURVEYS.....	9-4
A. Total Station or GPS RTK.....	9-4
B. Lead Lines.....	9-5
B.1 Depth Measurements	9-6
B.2 Positioning	9-6
B.2.1 Baseline Offsets.....	9-6
B.2.2 Total Station	9-7
B.2.3 Global Positioning System (GPS)	9-7
IV. REMOTE SENSING BATHYMETRIC SURVEYS	9-7
A. Single Beam Echosounders (SBEs).....	9-7
A.1 Instrumentation.....	9-7
A.2 Survey Procedures	9-10
A.3 Data Processing.....	9-11
B. Multi Beam Echosounders (MBEs)	9-12
B.1 Instrumentation.....	9-12
B.2 Survey Procedures	9-14
B.3 Data Processing	9-16
V. QUALITY ASSURANCE AND QUALITY CONTROL TESTS	9-17
A. Bar Check.....	9-17
B. Latency Check.....	9-18
C. Patch Test	9-18
D. Performance Check.....	9-19
E. Squat and Settlement.....	9-19
F. Cross Check Track Lines.....	9-19
VI. DELIVERABLES AND REPORT	9-20
A. Digital Files	9-20
B. Report	9-20

CHAPTER NINE

HYDROGRAPHIC/BATHYMETRIC SURVEYS

I. INTRODUCTION

A. HYDROGRAPHIC/BATHYMETRIC SURVEYS

Hydrographic or bathymetric surveys are measurements made, directly using conventional survey techniques or indirectly using remote sensing techniques, of the bottom of a hydrosphere (lake, river, pond, or stream). Traditionally it is “the branch of applied science which deals with the measurement and description of the physical features of the navigable portion of the earth’s surface, bodies of water, and adjoining land areas, with special reference to their use for the purpose of navigation.” In the same way that topographic maps represent the three-dimensional features of overland terrain, bathymetric maps illustrate the land that lies underwater. Bathymetry is the foundation of the science of hydrography, which measures the physical features of a water body. Hydrography includes not only bathymetry, but also the shape and features of the shoreline; the characteristics of tides, currents, and waves; and the physical and chemical properties of the water itself. For inland waters, hydrographic surveys are usually performed to depict underwater topographic features to enable engineers to perform civil works designs and compute hydraulic qualities of moving bodies of water.

For the purpose of this Manual, the Department considers hydrographic surveys to be those used to measure all bodies of water under its jurisdiction to design and construct civil works over or under bodies of water in or adjoining the jurisdictional boundaries of the State of Illinois.

In accordance with the Code of Ethics for Professional Land Surveyors in the State of Illinois and the Department’s need to ensure the highest level of competence in the performance of its work, all licensed surveyors working for the Department shall solicit, perform, and sign only work they are trained, experienced, or otherwise qualified to perform.

Drainage surveys are considered part of a topographic survey. While hydrographic surveys may be a part of a drainage survey, hydrographic surveys may also be performed independent of a drainage survey. Drainage surveys are more fully discussed in the [Department's Drainage Manual](#).

Hydrographic surveys performed in any body of water face similar challenges. There are a variety of methods available to accomplish the required results. While hydrographers normally possess the skill set and experience to select the proper techniques to accomplish a given hydrographic survey, one need not be a hydrographer to comprehend and perform these surveys for the Department.

Hydrographic surveys can be collected by conventional surveying techniques which include a leveling rod, a prism pole using a total station, or a fixed pole using GPS rover during RTK surveys. These conventional techniques are often referred to as manual or mechanical hydrographic surveying. The primary limitation to conventional surveys is water depth and bottom material. Water depths exceeding eight (8) feet are exceedingly difficult to measure based on the effects of wind, current, and access. While it is possible to perform mechanical surveys in water depths exceeding eight (8) feet, the conditions of the water should be a major part of determining if the process is a viable solution. Project conditions will dictate the preferred method to be used. In general, water depths exceeding fifteen (15) feet are generally considered too deep for mechanical techniques. While the use of rods and poles, referred to as sounding poles, are not necessarily the only conventional technique that can be employed, they are the primary conventional method. The use of lead lines, which allows measurements to be made in deeper water, is an alternate manual or conventional survey technique where elevation of the bottom is based on water depth. This method requires an alternate means of positioning as well as a more accurate means of water level determination such as portable stilling wells or gauge stations. Bottom material is an important consideration in hydrographic surveys and sounding poles should be fitted with suitable plates to meet the project needs. Bottom materials can range from hard packed to unconsolidated (fluff) where the actual bottom is very difficult to determine.

The primary method of performing hydrographic surveys today is the use of remote sensing equipment such as "echosounders." Echosounders are a form of Sonar (originally an acronym for Sound Navigation And Ranging), a technique that uses sound propagation to measure water depths. The use of echosounders is a complex technique that should only be performed by those trained and experienced in the many intricacies of the process to ensure adequate results are obtained. Echosounders are available from many manufacturers using a variety of technologies, but all are based on sound propagation through a water column.

There are single beam echosounders (SBEs), multi beam echosounders (MBEs), and even arrays of the combined units. The many variables and error sources present in hydrographic surveys include: sea state (waves and current); water quality and temperature to determine the speed of sound in the water column; bottom material and condition to determine where the reference bottom is; echosounder frequency appropriately chosen for the conditions; positioning of the reference point on the vessel; and, most importantly, heave, pitch, and roll compensation to correct for slope measurement as the vessel moves during data collection. These factors require a separate and distinct set of standards with respect to position and depth.

II. BOTTOM MATERIAL

A. UNDERWATER BOTTOM MATERIALS

Underwater bottom materials are varied. The hydrographic surveyor should make every attempt to determine the various bottom materials that will be encountered within the limits of the project. This can be accomplished by reviewing previous surveys and records or by inspection prior to planning and performing the work. Bottom materials for the purpose of this Manual are characterized as hard, soft, or unconsolidated. In addition to these general classifications there are subsets that will impact the methodology selected to perform the work. Vegetation may also be present in one or more of these bottom materials. Vegetation will also play a role in selecting the appropriate survey technique. It is normal that more than one survey technique may be required to perform a comprehensive survey over the limits of the project.

A.1 Hard Bottom

Hard bottom materials can consist of rock, sedimentary or otherwise, hard packed sand or gravel, hard packed silts, and other geologic formations or soil profiles. Both manual survey techniques and remote sensing techniques will successfully measure hard bottom surfaces to satisfactory accuracies, given the water column quality is appropriate for remote sensing.

A.2 Soft Bottom

Soft bottom materials are generally sedimentary materials that lack the shear strength to become consolidated enough to be considered hard packed. Soft bottom classification may be determined by the ability to easily penetrate the top layer of sedimentary materials by normal manual survey techniques such as leveling rods, prism poles, or other sounding rods. Soft bottom materials can present challenges to both manual and remote sensing techniques.

It is important to develop a uniform technique to be used in the survey, not only for consistency within the survey itself, but also to enable the results to be reproduced in subsequent surveys. Soft bottom surveys will require extra precaution when performing either mechanical or remote sensing surveys. Mechanical surveys will require that sounding rods be equipped with plates to facilitate a more uniform depth determination. Remote sensed (echosounder) surveys will require that the appropriate frequency be selected to detect the bottom.

A.3 Unconsolidated Bottom

Unconsolidated bottom materials can be present for a variety of reasons. They can be naturally occurring or caused by some mechanical influence. Naturally occurring low-density sediments can be present when low-density saturated soils are present. This condition can also exist where sediments are agitated from external mechanical sources. Fluid mud and other unconsolidated bottoms make it difficult to determine where the reference “bottom” should be located. In these instances, the surveyor (hydrographer) should carefully examine not only the bottom material density but the potential range of depth measurements where different survey techniques will measure to in the range. A manual technique such as sounding pole with sounding plate will measure to a different depth than one without or of a different weight and dimension. Likewise, a calibrated lead line with a standard bell anchor will vary in depth depending on the weight and shape. The acoustic measurement techniques will vary in depth measurement depending on the frequency of the transducer. A 200 kHz transducer will differ in depth measurement from a 24 kHz transducer, which will penetrate much further. Measurements in unconsolidated bottoms such as fluid mud could vary several feet depending on the technique employed. A discussion with the Department will determine the significance of the reference bottom and the impact on the project.

As an example, a project that might encounter an unconsolidated bottom may be a channel change project where the quantity for the unit cost of material dredged or excavated is paid for by cubic yard. In that instance it is imperative to determine where the reference bottom is and how it will be measured. This reference line will be used during both design and construction. The method used to establish the contract reference line is critical in order to reference future surveys and as-built quantities.

III. CONVENTIONAL BATHYMETRIC SURVEYS

A. TOTAL STATION OR GPS RTK

Using conventional surveying equipment to perform shallow water hydrographic surveys is acceptable with certain modifications. The use of prism poles and level rods as sounding poles is acceptable with the addition of a sounding plate attached to the bottom of the rod or pole. The purpose is to standardize the penetration of the rod or pole into the bottom material that is encountered. The rod or pole shall weigh eight (8) pounds combining both the rod, sounding plate, and prism or GPS RTK antenna/receiver. The sounding plate shall be a six (6) inch diameter circular metal plate, stainless steel is preferred, with four (4) one-inch diameter holes drilled symmetrically through the plate. It shall be attached to the rod or pole in a manner that allows for a stable and uniform pole or rod height to be measured/calibrated. The rod/pole height shall be measured before and after each survey from the bottom of the sounding plate to the center of the prism, or to the antenna reference point (ARP) plus the offset to the antenna electronic center. Where other than fixed height rods or poles are used, the various rod heights shall be calibrated and carefully recorded in the field notes.

The rod or pole combination shall be used in such a manner to allow free fall penetration into the bottom material. The rod or pole shall be plumbed prior to recording the measurement. No external pressure shall be applied. The uniform weight and height is important to note and maintain throughout the survey campaign. Generally rods over twenty (20) feet shall not be used, and depths over fifteen (15) feet shall not be measured except in instances where calm sea state is expected and little or no current or wind is encountered.

B. LEAD LINES

Lead lines are preferred in areas where depths will exceed the acceptable use of rods or poles. Generally the range of fifteen (15) feet to fifty (50) feet is the acceptable range of effective lead line measurements. Lead lines are made of materials that are flexible yet do not stretch under normal tension of pulling the line taught. Typical lengths of lead lines are fifty (50) to one hundred (100) feet. The lead line should be attached to a sounding plate (lead) or mushroom anchor. Both the sounding plate and anchor should be six (6) inches in diameter and weigh eight (8) pounds. The lead line should be graduated in tenths (0.1) of a foot throughout the entire length. The bottom of the sounding plate or anchor should be the zero (0) reference point to the lead line attachment.

The markings on the lead line need not be referenced to the bottom of the sounding plate or anchor, but the fixed dimension from the reference point should be recorded in the field notes and updated if a new connection to the lead line is necessary.

B.1 Depth Measurements

Depth measurements from lead lines are made using the water surface as the point of reference. Water surfaces in lakes or ponds are easily recorded to the nearest tenth (0.1) of a foot. The water surface elevation should be recorded before the depth measurements are made, and again after the measurements are completed, on a daily basis. On larger lakes, care needs to be taken to ensure the water elevation measurements are proximate to the soundings to minimize the effects of wind on water elevation. On rivers and streams, water elevation needs to be established at the location of the soundings to mitigate the changes in water elevation due to water surface profiles. Water surface profiles are not necessarily straight line proportions based on distance due to channel and floodway characteristics. While gauge stations are a good source of reference, temporary stilling wells combined with local vertical control will enable water surfaces to be measured frequently.

Care shall be taken to ensure the lead line is in free fall when the measurement process is started and is allowed to penetrate the bottom material for a duration of at least five (5) seconds before pulling the line taut and recording the depth. When the line is pulled taut it should also be confirmed that it is plumb and measuring on the slope is minimized. The lead line shall be held taut for sufficient duration to mean any variance in the sea state.

B.2 Positioning

The position of the sounding can be accomplished by a variety of methods. Care needs to be taken to ensure the positioning technique will meet the accuracy criteria for horizontal positioning of the depth measurement.

B.2.1 Baseline Offsets

Measurements may be made with a tape from a referenced baseline. Care should be used to ensure that the sounding is made on a line of known reference to the baseline—in other words, perpendicular or otherwise. The tape should be slack from point to point and taut at the instant of measurement. Generally this technique is limited to positions not far from shore.

B.2.2 Total Station

Positioning by the use of a total station is much more accurate and preferred over the use of a manual measurement using a tape. A 360° prism or combination of prisms may be fixed to the vessel near the lead line deployment point. Voice or visual coordination should be used to time the depth measurement with the position measurement. Current technology supports the use of a robotic total station which is controlled at the vessel and significantly reduces the opportunity to introduce errors into the data.

B.2.3 Global Positioning System (GPS)

Positioning by GPS using RTK techniques is the preferred method of positioning. The RTK antennae should likewise be fixed to the vessel near the lead line deployment point. As with the use of a total station, robotic or otherwise, care must be taken to coordinate the position with the depth measurement. A variety of methods may be used and the adopted procedure should be detailed in the hydrographic section of the Survey Report.

IV. REMOTE SENSING BATHYMETRIC SURVEYS

A. SINGLE BEAM ECHOSOUNDERS (SBEs)

Single Beam Echosounders (SBEs), also called Vertical Beam Echosounders (VBEs), are by far the most widely used instrument for acoustic depth measurements. They have been used regularly since the 1930s and while equipment has changed since then, they are still the mainstay of many hydrographic survey projects. Choice of equipment is important to maintain the accuracy required and to ensure that measurements can adequately be corrected for the many variables encountered. It is not acceptable to use depth finders or fish locators to substitute for a professional grade acoustic depth measurement instrument. All equipment and techniques shall be specified in the Scope of Work and approved by the Department.

A.1 Instrumentation

SBE equipment may be analog or digital. However the more recent digital equipment is preferred. There are many manufacturers and most of them use similar acoustic principals. Nominal accuracies are generally rated by the manufacturers ± 0.1 ft. plus 0.1 to 0.5 percent of the depth. This equates to a precision range of ± 0.15 to ± 0.35 ft. in 50 feet and is independent of the acoustic reflection characteristics.

Digitally measured elapsed times are more accurate than those performed on older mechanical recording devices.

The transducer component of the system is the device that converts electrical energy into acoustic pulses, transmits those pulses, then receives the return pulses and converts the pulse back to electrical signals. A variety of frequencies are used for different applications. Most of the transducers in use range in frequency from 20 kHz (kilohertz) to 1,000 kHz. The frequency is chosen based on project requirements and conditions. In general, the Department considers frequencies in the range of 200 kHz to 208 kHz to be the preferred frequency to be used for hydrographic surveys for the Department. Alternate frequencies may be used with approval of the Department. The higher frequency transducer generally has a more focused beam width, customarily around 8 degrees or less. The more focused beam is usually more accurate with lesser side lobes. The disadvantage of narrow beam widths is the requirement for pitch and roll corrections due to the movement of the vessel. In addition, the higher frequency has high signal attenuation and is easily reflected by suspended solids in the water column or vegetation. Some project conditions will warrant the use of lower frequencies.

Narrow beam transducers require pitch and roll corrections. The narrow beam is most always a slant measurement. However, depending on the depth of the project and the beam width, sometimes sea state conditions are such that no correction needs to be made. A general rule of thumb is if an 8-degree beam width is used and vessel roll or pitch is less than 8 degrees, then no adjustment is necessary. The degree of pitch or roll and the depth determines whether or not a correction is necessary to reduce the slant measurement to a vertical. Trying to time the work with sea state conditions is often difficult and it is recommended to plan on making corrections. Most often pitch and roll is corrected along with motion sensors that also perform heave corrections. There are many motion-sensing devices and inertial systems that measure heave pitch and roll (HPR) that readily convert the slant measurement as well as minimize the effects of swells that produce heave. If project conditions require HPR corrections, the device should be specified and procedures discussed with the Department prior to performing the survey.

Positioning of the transducer while measurements are being taken is critical to the survey accuracy. Positioning can be accomplished in a variety of ways. Today, GPS is the most common method. Either differential or RTK may be used depending on project accuracy specifications.

Robotic total stations with radio link may also be used to determine the position. A common practice today is to mount the GPS antenna or prism on the mount that holds the transducer. This is not mandatory, but the vessel should be carefully surveyed to record all offsets from the center of the transducer to the GPS antenna as well as the center of gravity (COG) of the vessel and the HPR or MRU (motion reference unit). All offsets fore and aft, port and starboard, and up should be carefully measured and recorded. Generally a vessel drawing in plan and profile helps to depict the offsets and record the equipment type and location during the survey.

The timing of all the sensors on the vessel is an important aspect of the process. The change or difference in timing between sensors is called "latency." Timing of the depth recording with the position is critical. Depending on the system configuration, this latency should be measured and accounted for. A Latency Test should be performed and the correction applied in the data collection software.

Water temperature and other conditions such as pollutants or suspended solids affect the speed of sound through the water column. All of the Department's hydrographic surveys will be performed in fresh water. Therefore, salinity is not an issue. Still the velocity of sound in water can be variable and to ensure accuracy, it should be measured. In fresh water, sound travels at about 1,497 m/sec. at 25 degrees Celsius. It decreases in colder temperatures and increases in warmer temperatures. A velocity meter (velocimeter) and a velocity profiler are instruments that record the speed of sound in the water. The speed of sound measurements should be taken at the project site. Generally in shallow rivers or small lakes, the water temperature is fairly uniform and need only be measured at the beginning and end of the survey. In deeper water where temperatures can vary more widely, it is critical to monitor water temperatures. A temperature change of 10°F will change the velocity by as much as 70 ft./sec., or 0.8 ft. in 50 ft. of water. A bar check, to be discussed later, can be used in conjunction with, or in lieu of, the velocity meter or profiler in shallow water.

Data collection software is required to adequately collect not only the sounding data but all the peripheral measurements necessary to correct the depth measurement and record positions. The software manufacturer will detail the setup procedures and collection process to ensure accurate data is collected. The data collection software shall be specified in the project proposal and details of all the sensor configurations shall be discussed.

A.2 Survey Procedures

Single Beam Echosounder surveys are often carried out similarly to conventional cross sections on land. Most hydrographic data collection software suites also contain planning modules as well as processing modules. Planning should consist of determining the orientation of the track lines (transects) and the interval, speed of the vessel, and other pertinent guidelines. A transect is a straight line or narrow section through an object or natural feature or across the earth's surface, along which observations are made or measurements taken. Transects are run parallel with the shore, perpendicular to the shore, or otherwise oriented depending on project location and requirements. The spacing or frequency of the transect locations will be determined by the Department based on project requirements and detailed in the Scope of Work. Regardless of the orientation of the transects, additional transects shall be run perpendicular as checks. The spacing of the check transects need not be at the same interval as the original and will be specified by the Department. Check transects shall be run the same day as the original survey if possible to minimize the effects of bottom changes.

Prior to commencing the survey, a bar check shall be performed using a minimum of five (5) foot depth intervals. The speed of sound profile should be measured and recorded in the data collection software. In shallow hard bottom conditions an additional check using lead line or sounding pole may be useful in documenting the survey. Additional checks shall be performed in accordance with manufacturer's recommendations for all sensors on the vessel. At the end of the survey day an additional bar check should be performed and recorded.

Single beam echosounders collect data at different sampling rates varying from 5 to 20 or more measurements per second. The rate at which soundings are made or collected is usually adjustable in the data collection software. This rate is dependent on speed of the vessel, depth of water, and transducer beam width. These three variables can be used to estimate the preferred update rate. Since these variables change over the course of each day's survey, the minimum values should be used to plan the day's work. In general, the Department recommends that most surveys be performed at 100 milliseconds (10 depths/sec.) to 200 milliseconds (5 depths/sec.) at 10 knots or less. In rock cut areas, 50 to 100 milliseconds is required. Vessel speeds exceeding 10 knots are not recommended, but this is dependent on conditions.

It is necessary to confirm that all sensors are communicating with the data collection software to ensure that positions and depth corrections will be appropriately applied. During the survey the vessel loading should remain uniform. Crew members should not move about the vessel or relocate stored objects on the vessel during the data collection process. The original vessel configuration used to perform any calibration tests, latency tests, squat, or settlement should be maintained as close as possible. An initial velocity profile shall be measured at the project site before commencing data collection. Where a velocimeter is not used at the transducer, the surveyor shall monitor the water column for changes. Depending on conditions, a mid-day and an end-of-day velocity profile cast may be required. During the collection process, a pilot is generally tasked with maintaining course and ensuring safe operation of the vessel. A second crew person is generally tasked with operation of the data collection software and ensuring that all peripheral sensors are operating and measuring within specifications. A third crew person is sometimes valuable to help with bar checks, sounding pole verifications, RTK checks, velocity casts, docking, and various other vessel duties.

A.3 Data Processing

Data Collection processes during the survey may vary based on the software employed. Processing shall follow manufacturer's recommendations but shall at a minimum follow the guidelines discussed in these specifications. All raw data files shall be kept in un-edited form and protected from loss by backup procedures. Raw data files shall be submitted with the final deliverable and mapping.

Edits made to the raw data must be carefully tracked and documented. Outlier depth recordings may be edited by procedures outlined in the data collection and processing software suite of choice. Edits may be made in batch mode by using filters or as may be deemed appropriate for the data set by the surveyor. Transects may be edited individually or in batch mode. The track line (path) of the vessel may require edits due to temporary loss of positioning. All edited files will be carefully scrutinized to ensure that all heave, pitch, roll, yaw, and latency corrections are appropriately applied to all measurements. Likewise all water velocity adjustments should be made if required. The edited files should also be carefully protected by backup procedures and used in the final analysis and preparation of the deliverable.

Cross line checks should be reviewed and the cross line elevations compared to the initial elevations by interpolating the depth measurements. These checks may be processed manually but some software suites automate the process. In either case the checks should be statistically reported at the one standard deviation and 95% confidence level.

All edited data files can then be used to produce the project deliverable, either mass points, cross sections, digital terrain model, or depth soundings as required by the Department. It may be necessary to truncate, often called binning, the data set due to the large number of soundings present on each track line. While deliverables may be processed in the hydrographic software suite, the dataset should ultimately be exported to Microstation (GeoPack) format as required in the Department's CADD deliverable process.

B. MULTI BEAM ECHOSOUNDERS (MBEs)

Multi Beam Echosounders (MBEs) are widely used today where complete bottom coverage is of primary concern. The use of the technology has been common since the 1990s for shallow water applications. MBE manufacturers use beam forming or interferometric (phased array) techniques to produce a fan-shaped beam, or swath (cross section), that acoustically measures many times per second. The swath width will vary between manufacturers and can range from two (2) to fourteen (14) times the water depth. Generally a beam width of 120 degrees is preferred. Choice of equipment is important to maintain the accuracy required and to ensure that measurements can adequately be corrected for the many variables encountered. The use of MBE requires very specialized equipment, highly trained operators, and extensive QC/QA during the entire process. All equipment and techniques shall be specified in the Scope of Work and approved by the Department.

B.1 Instrumentation

MBE equipment may vary widely based on the manufacturer and the technology applied. Whether mechanical beam forming or electrical beam forming is used, or the phased array technique, the specifications will vary widely. The manufacturers' recommendations should be followed closely and any variance to these performance-based specifications should be discussed in the project Scope of Work, and later reported in the Survey Report.

The transducer component of the system is the device that converts electrical energy into acoustic pulses, transmits those pulses, then receives the return pulses and converts the pulse back to electrical signals. Multi beam transducers are often based on a cross fan shape, a transmit array, and a receive array, typically an “L” or “T.” Multiple transducer elements make up the array. Arrays may be flat or conical depending on the manufacturer. As with SBE, MBE transducers vary depending on the manufacturer. The frequency to be used for hydrographic surveys for the Department will be determined based on project requirements. The higher frequency transducers generally have a more focused beam width. The more focused beam is usually more accurate with lesser side lobes. The disadvantage of multi beam arrays is the requirement for pitch and roll corrections due to the movement of the vessel. In addition, the higher frequency has high signal attenuation and is easily reflected by suspended solids in the water column or vegetation. Some project conditions will warrant the use of lower frequencies.

Multi beam transducers require heave, pitch, roll, yaw, and latency corrections. The outer beams of multi beam arrays are very susceptible to the effects of pitch and roll. Even small degrees of roll can make large errors in the outer beams. Most often, pitch and roll is corrected along with sensors that also perform heave corrections. In addition to heave, pitch, and roll, multi beam arrays also need to be corrected for yaw since they are fan-shaped. There are many motion-sensing devices and inertial systems that measure heave, pitch, and roll (HPR) that readily convert the slant measurements of all the beams as well as minimize the effects of swells that produce heave. If project conditions require the use of MBE then HPR corrections will need to be made. The motion-sensing device, HPR, or IMU (inertial measurement unit) should be specified and procedures discussed with the Department prior to performing the survey.

The timing of all the sensors on the vessel is an important aspect of the process. The change or difference in timing between sensors is called “latency.” Timing of the depth recording with the position is critical. Depending on the system configuration, this latency should be measured and accounted for. A Latency Test can be performed and the correction applied in the data collection software. As with Single Beam Echosounders, timing of the depth recording with position is critical. The potential Latency errors in a multi beam system are even more critical.

Positioning of the transducer while measurements are being taken is critical to the survey accuracy. Positioning can be accomplished in a variety of ways. Today, GPS is the most common method. Either differential or RTK may be used depending on project accuracy specifications.

Robotic total stations with radio link may also be used to determine the position. A common practice today is to mount the GPS antenna or prism on the mount that holds the transducer. This is not mandatory, but the vessel should be carefully surveyed to record all offsets from the center of the transducer to the GPS antenna as well as the center of gravity (COG) of the vessel and the HPR. All offsets fore and aft, port and starboard, and up should be carefully measured and recorded. Generally a vessel drawing in plan and profile helps to depict the offsets and record the equipment type and location during the survey.

Water temperature and other conditions such as pollutants or suspended solids affect the speed of sound through the water column. All of the Department's hydrographic surveys will be performed in fresh water. Therefore salinity is not an issue. Still the velocity of sound in water can be variable and to ensure accuracy, it should be measured. In fresh water, sound travels at about 1,497 m/sec. at 25 degrees Celsius. It decreases in colder temperatures and increases in warmer temperatures. A velocity meter and a velocity profiler are instruments that record the speed of sound in the water. The speed of sound measurements should be taken at the project site. Generally in rivers or small lakes the water temperature is fairly uniform and need only be measured at the beginning and end of the survey. A temperature change of 10°F will change the velocity by as much as 70 ft./sec., or 0.8 ft. in 50 ft. of water. A bar check, to be discussed later, can be used in conjunction with or in lieu of the velocity meter or profiler.

Data collection software is required to adequately collect not only the sounding data but all the peripheral measurements necessary to correct the depth measurement and record positions. The software manufacturer will detail the setup procedures and collection process to ensure accurate data is collected. The data collection software shall be specified in the Project Proposal and details of all the sensor configurations shall be discussed in detail.

B.2 Survey Procedures

Multi Beam Echosounder surveys are often carried out along predetermined lines called transects. Most hydrographic data collection software suites also contain planning modules as well as processing modules. Planning should consist of determining the orientation of the track lines (transects) and the interval, speed of the vessel, and other pertinent guidelines. Transects are run parallel with the shore, perpendicular to the shore, or otherwise oriented depending on project location and requirements.

The spacing or frequency of the transect locations will be determined based on the needs of the Department and based on project requirements and detailed in the Scope of Work.

Depending on project requirements, if full bottom coverage is required, then transects should be spaced to provide sufficient overlap in the swath measurements. Full bottom coverage may require that swath coverage is 200%. That is, the edge of adjacent swaths should overlap up to the nadir beam of the previous swath, resulting in the complete bottom being measured twice (200%). On projects where 200% coverage is not required, minimum swath overlap shall be 15%. This generally provides an optimal balance between the ability of the vessel pilot to stay on course and the cost of the survey. Lesser overlap may be employed at the discretion of the Department.

Prior to commencing the survey, a bar check shall be performed at a minimum of five (5) foot depth intervals. The speed of sound profile should be measured and recorded in the data collection software. In shallow hard bottom conditions, an additional check using lead line or sounding pole may be useful in documenting the survey. Sometimes a single beam echosounder measurement may be used for validation. For multi beam systems, the bar check needs to include not only the nadir beams but the outer beams as well. Additional checks shall be performed in accordance with manufacturer's recommendations for all sensors on the vessel. At the end of the survey day an additional bar check should be performed and recorded.

Prior to performing the data collection a Patch Test shall be performed. The patch test shall be used to set the correction parameters in the software. Once a high-quality calibration has been performed, it should remain valid until system components are moved or altered. Patch tests performed prior to arriving on the project are acceptable, but should be verified by a Performance Test when multiple days of soundings are planned. Both a Patch Test and Performance Test are described in this Chapter. (See [Section V](#), subsections [C](#). and [D](#).)

Multi beam echosounders collect data at different sampling rates varying from 5 to 20 or more measurements per second. The rate at which soundings are made or collected is usually adjustable in the data collection software. This rate is dependent on speed of the vessel, depth of water, and transducer beam width. These three variables can be used to estimate the preferred update rate. Since these variables change over the course of each day's survey, the minimum values should be used to plan the day's work.

In general, the Department recommends that most surveys be performed at 100 milliseconds (10 depths/sec.) to 200 milliseconds (5 depths/sec.) at 10 knots or less. In rock cut areas, 50 to 100 milliseconds is required. Vessel speeds exceeding 10 knots are not recommended, but are dependent on conditions.

It is necessary to confirm that all sensors are communicating with the data collection software to ensure that positions and depth corrections will be appropriately applied. During the survey, the vessel loading should remain uniform. Crew members should not move about the vessel or relocate stored objects on the vessel during the data collection process. The original vessel configuration used to perform any calibration tests, latency tests, squat, or settlement should be maintained as close as possible. An initial velocity profile shall be measured at the project site before commencing data collection. Where a velocimeter is not used at the transducer, the surveyor shall monitor the water column for changes. Depending on conditions a mid-day and an end-of-day velocity profile cast may be required. During the collection process, a pilot is generally tasked with maintaining course and ensuring safe operation of the vessel. A second crew person is generally tasked with operation of the data collection software and ensuring that all peripheral sensors are operating and measuring within specifications. A third crew person is sometimes valuable to help with bar checks, sounding pole verifications, RTK checks, velocity casts, docking, and various other vessel duties.

B.3 Data Processing

Data Collection processes during the survey may vary based on the software employed. Processing shall follow manufacturer's recommendations but shall, at a minimum, follow the guidelines discussed in these specifications. All raw data files shall be kept in un-edited form and protected from loss by backup procedures. Raw data files shall be submitted with the final deliverable and mapping.

Processing multi beam data is a complex process that must be carefully executed in accordance with the software specifications being used. Generally editing is done in a prescribed format and sequence to ensure the quality of the data. Edits made to the raw data must be carefully tracked and documented. Outlier depth recordings may be edited by procedures outlined in the data collection and processing software suite of choice. Edits may be made in batch mode by using filters, or as may be deemed appropriate for the data set by the surveyor. Transects (track lines) may be edited individually or in batch mode. The track line (path) of the vessel may require edits due to temporary loss of positioning.

All edited files will be carefully scrutinized to ensure that all heave, pitch, roll, yaw, and latency corrections are appropriately applied to all measurements. Likewise, all water velocity adjustments should be made if required.

The edited files should also be carefully protected by backup procedures and used in the final analysis and preparation of the deliverable.

An important aspect of MBE data review is a graphical evaluation of the swath coverage for overlap. Each track line swath needs to overlap adjacent track lines in accordance with the project requirement. This process is automated in some software suites. In addition to measuring the percent overlap, this process also ensures there are no gaps (holes) in the data set.

All edited data files can then be used to produce the project deliverable, either mass points, cross sections, digital terrain model, or depth soundings as required by the Department. It will be necessary to truncate or thin the data points, often called binning, due to the large number of soundings present in each track line swath. While deliverables may be processed in the hydrographic software suite, the dataset should ultimately be exported to Microstation (GeoPack) format as required in the Department's CADD deliverable process.

V. QUALITY ASSURANCE AND QUALITY CONTROL TESTS

A. BAR CHECK

A bar check is a quality control test used to calibrate and check remotely sensed depth measurements. The bar is a flat plate, typically aluminum or stainless steel, suspended by one or two graduated lines over the side or bow of the vessel so that it is positioned directly under the beam, or nadir beam, of the echosounder. Depths are recorded to the nearest 0.1 ft. at predetermined intervals, often 5.0 feet down to the project bottom depth. The static draft of the transducer is used to check the depth of the bar under the water surface compared to the depth recorded by the echosounder. A series of depths calibrated at various intervals can be used to correct the depth measurements. Bar checks are more easily performed with two crewmen but can, on single beam echosounders, be performed by just one crew person. Bar checks for multi beam systems should measure both the nadir beam and the outer beams.

B. LATENCY CHECK

A latency check is used to determine a timing error bias. It is a part of a patch test which is used for multi beam residual bias measurements. It should also be performed by itself for single beam depth measurements in order to adjust the timing error bias. Timing error biases should be determined from two or more pairs of reciprocal lines 600 feet or more in length, over a 10- to 20-degree smooth slope, perpendicular to the depth contours. Timing error bias could also be determined from running lines over a distinct feature such as a log, rock, or other identifiable feature on the bottom, as long as the feature is ensonified by the beam.

C. PATCH TEST

A patch test is a residual bias measurement performed to calibrate multi beam data sets. It consists of a series of measurements for pitch, roll, latency, and yaw residuals that will be entered into the data collection and processing software to correct for the residuals. Generally two lines of data must be acquired to resolve each bias. Vessel speed, direction, and/or seafloor slope will be specified for each line. However, lines for each bias may be completed in separate areas if an ideal geographical location is unavailable. Once patch test data has been acquired, system integration errors are determined by aligning slopes and targets acquired from different directions and speeds, often automated in hydrographic software suites.

The order in which these biases are determined may affect the accuracy of the calibration for the multi beam system. The surveyor should determine the biases in the following order: navigation timing error (latency), pitch, roll, heading (yaw). Deviations from this order or other variations on the accepted calibration methods shall only be performed if allowed by the Department.

Pitch and navigation timing error biases should be determined from two or more pairs of reciprocal lines 600 feet or more in length, over a 10- to 20-degree smooth slope, perpendicular to the depth contours. The lines should be run at different speeds, varied by up to 5 knots, for the purpose of delineating the track line profiles when assessing time delay. Navigation timing error bias could also be determined from running lines over a distinct feature such as a log, rock, or other identifiable feature on the bottom, as long as the feature is ensonified by the vertical (nadir) beam.

Roll bias should be determined from one or more pair of reciprocal lines 6 00 feet in length or more over a flat bottom. Lines should be run at a speed which will ensure significant forward overlap.

Heading (yaw) bias should be determined from two or more adjacent pairs of reciprocal survey lines, made on each side of a submerged object or feature such as a log, rock, or other identifiable feature, in relatively shallow water. Features with sharp edges should be avoided. Adjacent swaths should overlap by 10 to 20 percent while covering the feature. Lines should be run at a speed which will ensure significant forward overlap.

D. PERFORMANCE TEST

A performance test is primarily used during projects that require many days of data capture. It is best performed using a variety of independent systems to obtain varied measurements from which data sets may be compared between the systems. It may be performed by two different multi beam systems or a multi beam system and a single beam system, or even manual depth sounding techniques. However, it can also be performed using the same system multiple times to assess the repeatability of the system. Used in this fashion, a bias may be undetected and alternate measurements by other systems are of more value.

E. SQUAT AND SETTLEMENT

Squat and Settlement Tests are performed to determine the draft of the vessel and the amount of change when the vessel is underway. Static draft should be determined at half fuel when a full-day's measurement is anticipated with the full hydrographic crew on board the vessel and appropriately loaded with all equipment. Dynamic draft should be determined in the same manner as static draft but with the vessel underway at survey speed. Various methods are used to measure both static and dynamic draft and the method employed should be fully discussed in the Survey Report. This needs to only be employed when the water surface is used as the reference point for determining sounding elevations.

F. CROSS CHECK TRACK LINES

The regular system of transects (track lines) shall be checked by a series of cross lines for verifying and evaluating the accuracy and reliability of surveyed soundings and positions. Cross lines shall be run across all planned track lines at angles of 60-90 degrees where possible.

Cross lines shall be acquired and processed to the same accuracy and data quality standards as required for main scheme lines, and shall be included in the grids that are submitted as the final bathymetric product of the survey. For Single Beam Echosounder surveys linear length of cross lines shall be at least 10% of main scheme length in areas surveyed with single beam echosounder. The primary purpose of cross lines in a single beam echosounder coverage area is to identify systematic errors and blunders in the surveying system. Discrepancies between main scheme and cross line coverage indicate potential systematic errors in offsets, biases, or correctors; faulty positioning or echosounder operation; or other issues. The surveyor shall compare main scheme and cross line coverage to identify, evaluate, and rectify any such errors.

Cross lines may also be used to evaluate Multi Beam Echosounder surveys but the patch test and side overlap of the swath will most often be sufficient to analyze the data.

VI. DELIVERABLES AND REPORT

A. DIGITAL FILES

All digital files collected or prepared during the course of the project shall be inventoried and copied to storage media for delivery to the Department. File naming conventions shall be as required in the Scope of Work or as approved by the Department.

CADD files produced from the project may be submitted in digital native format but must also be delivered in MicroStation Geopack file format, as required by the Department CADD Standards.

B. REPORT

The Survey Report shall contain all relevant information about the Hydrographic Survey. If the Hydrographic Survey is a part of other surveys performed for the project, it is acceptable to cover the hydrographic portion in its own chapter or article of the combined Survey Report.

The report shall contain at a minimum, the following:

1. Title Page
2. Table of Contents
3. Introduction
4. Instrumentation and Software
5. Vessel Description and Offsets
6. Planning
7. Survey Implementation and Procedures
8. Quality Assurance/Quality Control Tests and Results
9. Processing and Editing
10. Summary and Project Deliverables

CHAPTER TEN
CONSTRUCTION SURVEYS

BUREAU OF DESIGN AND ENVIRONMENT
SURVEY MANUAL

May 2015

CHAPTER TEN

CONSTRUCTION SURVEYS

Table of Contents

	Page
I. INTRODUCTION	10-1
II. PRE-CONSTRUCTION	10-1
A. General	10-1
B. Field Notes.....	10-2
III. CONSTRUCTION.....	10-2
A. Communications with Contractor	10-2
A.1 Pre-Construction Conference.....	10-2
A.2 Surveyor-Contractor Relationship	10-2
B. Setting and Recording Layout Stakes	10-2
B.1 Accuracy	10-2
B.2 Service to the Contractor	10-3
B.3 Establish a Survey Line	10-3
B.4 Checking Work	10-3
C. Prepare in Advance	10-3
D. Methodology for Staking	10-3
D.1 General	10-4
D.2 Modern Methods	10-4
D.3 Older Methods.....	10-4
D.3.1 Staking Curves.....	10-4
D.3.1.1 Check Plans	10-4
D.3.1.2 Setting Stakes	10-5
D.3.2 Setting Stakes for Bridges	10-5
D.3.2.1 General	10-5
D.3.2.2 Triangulation and EDM System.....	10-6
D.3.2.3 Span Length.....	10-7
D.3.2.4 Locating Centerline.....	10-8
D.3.2.5 Staking Abutments	10-9
D.3.2.6 Staking Piers	10-9
D.3.2.7 Staking Cofferdams	10-9
D.3.2.8 Staking Footings	10-9

D.3.2.9	Miscellaneous Elevations	10-10
D.3.3	Setting Stakes for Borrow Pits and Cross Sections	10-10
D.3.3.1	Stakes for the Base Line	10-11
D.3.3.2	Stakes for Cross Sections	10-11
D.3.3.3	Original Cross Section	10-12
D.3.3.4	Final Cross Section	10-12
D.3.3.5	Pits Subject to Overflow	10-13
D.3.3.6	Computations	10-13
D.3.4	Setting Stakes for Grading	10-13
D.3.4.1	Slope Staking	10-14
D.3.4.2	Balance Points	10-14
D.3.4.3	Curve Superelevation	10-15
E.	Layout of Entrance Culverts	10-15
E.1	Location	10-15
E.2	Staking	10-15
E.3	Elevation of Headwalls	10-15
F.	Layout of Across-Road Culverts	10-15
F.1	Location	10-15
F.2	Staking	10-16
F.3	Elevation of Headwalls	10-16
G.	Layout of Pavement	10-16
G.1	Alignment and Grade	10-16
G.2	Field Book	10-16
G.3	Notes for Setting Grade Stakes and Stringlines for Automatic Grade Control Equipment	10-17
H.	Computer Applications	10-18
H.1	Field Control	10-18
H.2	Field Quantities	10-19
H.3	Quality Control	10-19
IV.	POST-CONSTRUCTION	10-19
A.	Final Measurements	10-20
A.1	Items Measured During Construction	10-20
A.2	Items Measured After Construction	10-20
A.3	Calculations of Quantities	10-20
A.4	Structures	10-21
A.5	Final Plans	10-21
B.	Monumentation	10-21
B.1	Final Alignment	10-21
B.2	Right-of-Way	10-21
B.3	Bench Marks	10-22
B.4	Traverse Stations	10-22

FIGURES

Sample Staking Diagram (Figure 10.1)10-23

Stakes for Borrow Pit Example (Figure 10.2)10-24

Right Angle Installation (Figure 10.3)10-25

Skewed Culvert Installation (Figure 10.4)10-26

Autograde Working from 1 Positive Hub, with Cross Slope System (Figure 10.5a)10-27

Autograde Working from 2 Stringlines, with 2 Positive Hubs (Figure 10.5b).....10-27

CHAPTER TEN

CONSTRUCTION SURVEYS

I. INTRODUCTION

Highway construction surveying can be divided into three categories: pre-construction, construction, and post-construction. The survey crew assigned to a project is responsible for conducting all surveys required in connection with making the necessary measurements to determine pay quantities. The survey crew chief has the primary duty of making certain that the State's obligations are met with regard to furnishing the necessary stakes and information needed to construct a project.

Please Note: This Chapter in the Survey Manual has been reproduced from the [Construction Manual, dated January 2006](#). Please refer to the current Manual and Section for additional information if needed.

II. PRE-CONSTRUCTION

A. GENERAL

When a construction surveyor is assigned to a construction project, he/she should carefully study and check the plans and special provisions. Any errors or omissions of significant proportion shall be brought to the attention of the project engineer, who will take the necessary steps to resolve them. The Department's position on these must be established prior to the pre-construction conference with the contractor. A thorough review not only detects errors, but also helps familiarize the surveyor with the project. He/she becomes better prepared to plan his/her operations when actual construction begins. Pre-construction plan review, note preparation, miscellaneous computations, and fieldwork are essential for a smooth operating construction project.

In order to properly construct a project, it is essential that the field layout work be done accurately. The following discussions give field personnel some guidelines to assist the staking operation. When the layout work and staking is done by the Contractor as a contract pay item, the Resident should review the Special Provisions to identify his/her responsibilities with regard to staking and checking.

B. FIELD NOTES

The standards for field notes are established earlier in this Manual. Please reference [Chapter 1, Section V](#) for these standards.

III. CONSTRUCTION

A. COMMUNICATIONS WITH CONTRACTOR

Harmonious relations with the contractor are essential for a smooth-operating project. This condition is best accomplished through good communications between the contractor, the engineer, the surveyor, and inspectors.

A.1 Pre-Construction Conference

Prior to the commencement of construction activities, a conference is held with the contractor and his supervisory personnel and the Department's engineering personnel. This meeting is of particular importance to the construction surveyor since he must plan and organize his duties to conform to the contractor's planned sequence of operations so that there will be no unnecessary delays or inconveniences. The contractor will outline his working schedule and methods of operations, and discuss construction details. He should be asked to furnish the Crew Chief a list showing the priority of staking needs. He shall be advised that he is required to give at least 24 hours' notice for any deviation from the list.

A.2 Surveyor-Contractor Relationship

It is important that the surveyor establish a working relationship with the contractor and his foremen. A cooperative foreman will make the surveyor's job much easier and greatly reduce the possibility of errors. The contractor should be made aware of the importance of maintaining traverse stations and bench marks.

B. SETTING AND RECORDING LAYOUT STAKES

B.1 Accuracy

Accuracy is the essential in setting vertical and horizontal control stakes. Remember that when you have set stakes, the Contractor assumes they are correct. In order to avoid complaints from the Contractor that stakes were improperly set or that s/he incurred additional expense because of an error in setting a grade, instruct the Contractor to notify you at once if at any time they consider a grade stake to be in error. This will give you a chance to check the elevation in a timely manner.

B.2 Service to the Contractor

Service to the Contractor is another essential feature of the work. Do not wait for the Contractor to ask for stakes, but take the initiative and confer with him/her to determine the portions of the work to be staked first. Agree upon the lines and grades desired, the clearances required for construction equipment, and other matters relative to the layout work. Arrange your work so you will always have sufficient stakes set ahead so the Contractor will not be delayed in prosecuting the work.

B.3 Establish a Survey Line

Before stakes can be set, the survey line must be established and verified. It is advisable to tie in all control points, such as P.I.s, P.O.T.s, P.C.s, and P.T.s to reference points outside the area of construction. Bench marks for use in construction should be set and checked before stakes are set. All level circuits used for setting stakes must be accurately closed on bench marks before stake elevations are used. Once stakes are set they should be guarded with lath and high-visibility flagging. The lath should clearly identify the stake and its use in order to avoid confusion.

B.4 Checking Work

Whatever the method of surveying used, the more checking you do, the possibility of errors or mistakes is greatly reduced. Grade elevations, curve data, etc., must be checked before being used. All measurements, level notes, and computed distances must be rechecked frequently. Check with the plans in hand instead of relying on memory. It is an embarrassment to the Department when a bridge is built to the wrong elevation or when the distance between bridge seats is too short or too long. These things have happened in the past, but they will be less likely to occur if the work is carefully checked.

C. PREPARE IN ADVANCE

It is essential that field books containing the necessary grades, sketches, tie points, bench marks, and other data be prepared in advance. Delays and inconvenience result if it is necessary to refer to the plans often for layout information. Notes and sketches should be independently checked. The books should contain grade elevations at the intervals required, survey line ties, bench marks, curve data, and any other data required for frequent use.

D. METHODOLOGY FOR STAKING

D.1 General

The field methods outlined below are acceptable methods for construction surveying. The Resident does not have to follow these methods and may use their own method. However, each suggested method is a good method to use if the Resident is in doubt as to how to proceed. Each method should be read carefully.

A standard method of staking should be followed but may be varied to meet topographical conditions, type of construction, equipment used, and the Contractor's preference. This is a convenience to Contractors who work in more than one District, and also reduces the chance of confusion and misunderstanding between Residents in the field and the District Office.

D.2 Modern Methods

With advances in technology over the last 20 years, construction staking has become far more automated for the field surveyor. Whether using GPS, total station, or robotic instrumentation, the data collection systems of today allow for staking of not only preset points but also a complete upload of the proposed model for the entire project. While this makes field calculation almost unnecessary, it is still imperative that the field crew must pay close attention to the stakes placed on the ground. It is also important to check with the office staff periodically to ensure that the most current model or points are loaded in the data collector.

D.3 Older Methods

D.3.1 Staking Curves

D.3.1.1 Check Plans

The point coordinates and curve data listed in the plans must be carefully checked, including the P.I.s and the P.O.T.s. You will encounter considerable difficulty in running in the curves if the intersection angles do not check and new curve data must be calculated. Usually, this is done when verifying the transit line. Any discrepancies found, which you do not know how to correct, should be discussed with your Supervisor.

If practical, re-establish P.I.s and the necessary P.O.T.s. Record intersection angles, reference all P.I.s and P.O.T.s, and record their stations and reference points.

D.3.1.2 Setting Stakes

Where practical, set up on the P.I. having as a foresight and backsight the P.I. or P.O.T. on either side of the P.I. over which you are set. Using the transit for line, measure accurately the tangent distance in each direction, and set substantial hubs at the P.C. and P.T. of your curve. The station number of the P.C. is the station of the P.I. minus the tangent distance. The station of the P.T. is the station of the P.C. plus the curve length.

Before running curves, the notebook table of stations, deflection angles, and chord lengths (including chord corrections if needed) must be set up and checked. Curve data from computer programs should be spot-checked. After the P.C. and P.T. are established, set up over the P.C. and proceed to run in the curve. Offset the stakes the proper distance each way from the centerline.

It is often necessary to run curves in the reverse direction to that of the stationing. On long curves where the view is obstructed, it is necessary to turn at one or more points on the curve.

Curves should close within about 0.25 feet per 1,000 feet of length. The error of closure should be proportionally distributed over sufficient length so that the eye can detect no break in the alignment. On flat curves having external distances of 2 feet or less, it is faster to run in the curves by tangent offsets.

D.3.2 Setting Stakes for Bridges

D.3.2.1 General

Prior to staking a bridge, plan dimensions and elevations must be checked. It is extremely important to check the bottom of footing elevations by working down from the profile grade line at each pier and abutment, using plan dimensions, beam depths, etc.

The entire structure must be staked before construction operations begin. Remember that the stakes you set are going to be used over and over again from the time you stake the footing excavation until the bridge is finally completed. As the work progresses, you will not be able to see from one stake to another as you did in the beginning

and you should give this fact consideration when staking the bridge. It is better to have a few extra points than not to have enough. A substantial number of stakes located out of the way of Contractor's equipment and material should be used. At least three stakes on each line should be set each way from the site. Check all elevations and be sure all the stakes are protected, well-referenced, and clearly identified.

When you have completed the staking, notify your Supervisor so that someone assigned to your office may make an independent check of your calculations and layout work before the Contractor starts work on the structure. When the layout work and staking is done by the Contractor as a contract pay item, the Resident must review the Special Provisions to identify his/her responsibilities with regard to staking and checking.

Thorough and accurate layout work that is checked by an independent party is essential for structures. However, the checking should not stop here. It is important to have positive control points on each pier and abutment so, as the bridge cone embankments are being constructed, instrument checks can be made easily to determine any movement. Be particularly careful when the embankment toes out near the bottom of tall piers, as frequently happens with railroad structures.

Each stake set should be recorded, as well as all elevations that are given to the Contractor. It is good practice to sketch each feature of the bridge and show the stakes with the references and distances of their respective locations. See [Figure 10.1, page 10-23](#) for a sample staking diagram. It is also a good practice to share staking diagrams and information with the Contractor to avoid possible future disputes.

D.3.2.2 Triangulation and EDM System

On multiple or long span bridges, especially bridges with steel superstructures where the width of the stream or other conditions prevent direct measurements, the location of abutments of piers must be measured with an electronic distance measuring (EDM) system and/or by triangulation methods. Precise methods are required in such work and are necessary for long structures.

The EDM system or triangulation should be supervised by the Resident in charge of the work.

In triangulating locations for long bridges, concrete monuments or large stakes set deep and cut off near ground level, etc. should be used. Remember that the location may be affected by freezing and thawing, floods, driftwood, and ice. Measurements should be corrected for temperature and a scale should be used to set the pull that is standard for the tape that is used. Long measurements should be made with an EDM. When possible, intersection lines should be set for each pier at an angle of 45 degrees with the base line, and the base line should extend both sides from the centerline of the bridge. The intersection lines should be run out to points above high water on both sides of the river so that the locations can be set when the low ground is flooded. Angles should be set using repetition and should be checked by measurements. Guard stakes should be placed at each hub and the layout should be marked so that no confusion may result.

In some cases it is desirable to establish a low water and a high water base line. A base line that is above low water elevation can usually be placed nearer the bridge site and will be found very convenient.

D.3.2.3 Span Length

In staking the abutments, an allowance must be made for any anticipated deflection of the abutments so that the span length after deflection will be as shown on the plans. Theoretically, the amount of deflection can be figured, but practically it is somewhat indeterminate because of the variable conditions of the footings and backfill. It is assumed that the pressure of the backfill will move the top of a closed abutment or a concrete pile abutment horizontally 1/16-inch for each foot of height measured from bridge seat to bottom of footing. For open abutments, the assumed movement is 1/32 of an inch per foot.

In the case of a single span, if a correction is necessary for the deflection of the abutments, add the total deflection of both abutments to the span length shown on the plans to get the length for locating the abutments.

In case of a multiple span bridge, add the deflection of one abutment to the length of the end span only.

D.3.2.4 Locating Centerline

Care must be exercised in locating the centerline of a structure. The centerline of roadway and structure are not always the same. From the road plans or original survey notes, establish at least two P.I.s or P.O.T.s in each direction from the bridge and tie them in permanently. This should be done to ascertain if the intersection angle in both directions from the bridge is correct. If the P.I. or P.O.T. in each direction cannot be seen from the bridge, establish a P.O.T. on each side of the bridge and as close to the original P.I. or P.O.T. as possible. Place a permanent hub on centerline each side of and as close to the bridge as possible without interfering with the Contractor's operation. The Contractor should be requested to assist you by keeping equipment and materials clear of the line between these hubs. When possible, a permanent foresight should be set on the centerline of the bridge as high as the ground permits. It should be possible to set centerline from either side of the stream.

Establish hubs on centerline of bearing or back of abutments and on the centerline of each pier. These hubs should be heavy stakes and nails should be used for line.

It is very important that the Resident and Contractor clearly understand and agree on what lines are staked. You may provide the Contractor with a sketch of all lines and stakes set.

Establish permanent bench marks close to the bridge. The bench marks on the plan or original survey must be checked before establishing your benches at the bridge site. Transfer your bench marks to permanent concrete or piling on the structure. Use the bench marks established on the structure for the remaining work. Do not set temporary bench marks on newly constructed embankments since they may settle. Be sure that your transit and levels maintain proper adjustment.

D.3.2.5 Staking Abutments

On the hub that is set on centerline of bearing or the back of abutment with the centerline of structure set up and turn the skew angle; on this line, set hubs—one close to the bridge and two at distances of 200 and 400 feet. If this cannot be done, set them as far as possible from the bridge. Check the skew angle by repetition before proceeding.

D.3.2.6 Staking Piers

From the hubs established on centerline of the structure turn the skew angle and set additional hubs in each direction, the same as you did for the abutment. Care must be exercised in establishing this line since the centerline of bearing and centerline of pier are not always the same. The vertical alignment of piers should be monitored with a transit during concrete placement.

Measure the distance from the centerline to each hub and record it. Measurements for bridge layouts are often made on rough, uneven ground. It is necessary to have the chain horizontal and to use a plumb bob for accurate measurements on such terrain. Check your measurements often. Whenever possible, physical measurements should be made as the work progresses.

D.3.2.7 Staking Cofferdams

In fixing the location of cofferdams, it is usually best to give the Contractor only the center of the pier and the centerline of the structure.

The Contractor can then determine the width and length, knowing what allowance is needed for footing forms, drainage outside the forms, size of walers and struts, etc. Cofferdams in deep water may be located by triangulation. Proper alignment may be secured by placing marks at the intersection of the centerlines with each edge of the frame to be spotted and moving the frame until both marks are on the transit line.

D.3.2.8 Staking Footings

Check carefully the elevation of the bottom of the footing as shown on the plans and compare it with the distance below streambed that you actually find.

If there is a discrepancy of one foot or more, consult your Supervisor.

Keep the Contractor informed at all times as to the work you are doing, and give him/her a record of all stakes set. When the neat line forms of the footing are in place, the top of footing should be established by setting nails with an instrument at convenient points around the footing. When footings are too deep to set elevations directly, turns may be established by measuring down to a nail from a point of known elevation.

D.3.2.9 Miscellaneous Elevations

After the forms for either an abutment seat or pier cap have been built, grade points for the bridge seat elevations should be set with an instrument. The level circuit for setting the bridge seat elevations should be checked by using one of these set elevations as a turning point. Elevations at tops and wings should also be set with an instrument. Seat elevations should be checked after the concrete is placed. Bridge seat elevations should be checked by subtracting the deck thickness, minimum fillet, permanent camber (if any), beam heights, and bearing heights from the finished deck elevations before laying out the bridge seat elevations in the field.

On steel truss spans supported by falsework, it is essential that each panel point of support be set at the exact camber elevation before any connections are made.

D.3.3 Setting Stakes for Borrow Pits and Cross Sections

Although setting stakes and running cross sections for a borrow pit seem to be simple matters they are, nevertheless, matters that call for more than ordinary accuracy. Inaccuracy or lax procedures anywhere from start to finish will almost certainly result in confusion and possibly in a dispute with the Contractor over the volume involved.

If the borrow pit is furnished by the State, it should be staked before construction starts so that the Contractor will not encroach upon private property. If the Contractor furnishes the pit, s/he should obtain the necessary approval and show you the location of the boundaries in sufficient time to take cross sections.

When the pit is furnished by the State, establish its location from the plans. For pits adjacent to the right-of-way, it is often convenient to use the centerline as a base line, if on a tangent. Usually the base line should be chosen parallel to the long dimension of the pit, which means that it may not always be parallel to the centerline of the roadway. In all cases, the base line must be readily re-established or preserved until all work is finished. If the centerline is not used, the base line chosen should be tied accurately. Base lines should always be straight lines regardless of the shape of the borrow pit. It is often convenient to locate the base line in a fence line or other location where hubs on the line will not be destroyed. The base line should be referenced to points which will remain after borrow is completed.

See [Figure 10.2, page 10-24](#) for a typical borrow pit layout.

D.3.3.1 Stakes for the Base Line

The drawing indicates the pit is parallel to the centerline. The base line is parallel to the centerline and is as close to the borrow pit as can conveniently be placed without being disturbed by the Contractor's operations. From the base line run a parallel line on the opposite side of the borrow pit and reference it, locating it close to the pit (perhaps within 10 feet) but out of the way of the Contractor's operation. Use an instrument to turn angles and a steel tape for all measurements, and be sure to have the lines on each side of the borrow pit well hubbed and referenced. Base line stakes should be marked with the station numbers and driven solidly. Borrow pits often stand over the winter season before borrow is completed.

You must be able to re-establish any line easily, at any time, at its exact original location. If the boundary of the borrow pit is a curved line, this curvature must be taken into consideration in taking cross sections and computing final quantities.

D.3.3.2 Stakes for Cross Sections

The base line and its parallel line on the opposite side of the borrow pit are marked lines "A" and "B." The borrow pit limits as staked out are to be visible, carefully referenced, and accurately measured from the centerline.

On line "A" at 25-foot intervals (or not more than 100 feet), and at all breaks in the grade, set stakes. Record the distance to each stake. Set a corresponding stake on line "B" by turning an angle of 90 degrees from line "A." In placing stakes on the original ground surface, keep in mind the contour of the finished pit and take enough points to cover breaks in both the original and final ground lines. Do this along the base line, its parallel line, and along each cross section. It is often convenient to use a range pole or flag, set at the far end of the sections to be taken, as a foresight to ensure that the sections are taken on a straight line and in the proper location.

D.3.3.3 Original Cross Section

Cross sections must be taken before excavation starts. Establish a permanent bench mark close to the borrow pit, using the plan datum if possible. Then take readings along each cross section established between line "A" and "B," making those readings often enough to get all the breaks in the grade on each section measuring the distance to each point accurately. Have the cross section readings extend several feet outside of lines "A" and "B." It is a good idea to take a few cross sections beyond the ends of the borrow pits also, as it may be necessary to enlarge the pit after excavation starts. Be sure to check cross section distances against stakes previously set in the base line and offset line. Close the level circuit on a bench mark of known elevation.

D.3.3.4 Final Cross Section

After the excavation is completed and the borrow pit shaped, you should re-cross section the pit at the identical locations used previously.

In addition, cross sections should be taken at the breaks between the back slopes and level parts of the pit. Original sections at these points may be interpolated. Usually, it is not possible to determine such points in advance. The re-cross sectioning should be done as soon as possible. It may be necessary to take cross sections before the borrow pit is leveled off, if the Contractor delays this finishing very long, because of the danger of the contour of the pit being changed by heavy rains. It is convenient to check borrow pit drainage in connection with the final cross sections.

D.3.3.5 Pits Subject to Overflow

If the borrow pit is subject to overflow and the Contractor suspends work for any considerable length of time, the pit should be cross sectioned immediately after work stops. If overflow occurs, the pit must again be cross sectioned before work starts as alluvial deposit may appreciably affect the quantities.

D.3.3.6 Computations

Plot your notes and compute the volume used on the project by the Contractor. If computations are to be made in the District Office Computer Section, retain a copy of your cross section notes. It is a good idea to spot check the cross sections yourself to make sure they close.

D.3.4 Setting Stakes for Grading

Usually, three sets of stakes will be used for controlling a construction contract: (a) Right-of-way, Control, and Structure; (b) Preliminary Grade; and (c) Finish Grade.

Before you start setting stakes, consult the Contractor to learn whether your proposed method will suit his/her convenience. As much as possible adjust your method to his/her wishes. After you have come to an agreement, make a note of it in your field book, and make certain that the Contractor understands just what method of staking you will use, at what points stakes will be set, and how they will be marked. It is best to give him/her this information in writing, as this may avoid a future controversy. A 5-foot offset, if possible, will permit satisfactory distances from the toe of slope or edge of ditch to permit the Contractor sufficient workroom for his/her operation.

Each cut or fill entered on the grade stakes should be recorded in the field book. Prior to the contractor beginning dirtwork operations, the original ground elevations should be spot checked for accuracy.

After the earthwork is roughed in, the Contractor will request a line of stakes, usually down the centerline of the roadway, to establish the completed crown grade. This line of stakes should be set with an instrument and the grade shown as requested by the Contractor. When the roadway is built as close to grade as possible with the previous stakes, it will then be necessary to set line stakes and paving stakes at 50-foot intervals.

Closer intervals are required on a tight horizontal or vertical curve. These stakes should be of hardwood, preferably a 1-in x 2-in or 2-in x 2-in size, or metal of sufficient length to penetrate the grade far enough that the movement of equipment will not cause variations once the grade is established.

The sub-base and pavement can be built from these paving stakes. The Contractor should be cautioned against destroying the stakes. If this condition is encountered, the Specifications permit a fee that can be assessed for replacing the stakes.

D.3.4.1 Slope Staking

Before the Contractor begins earthwork operations, it may be necessary to place slope stakes to define the toe of the slopes for ditches and/or fill areas. It is important to consult with the Contractor to determine what information will be necessary. Usually the stakes indicate the station location, cuts or fills for roadway and ditch, rate of slopes, and the offset distance from the stake to the toe of slope.

Because of the large amount of information required, the Contractor should provide pointed 1-in x 6-in boards (paddles) to record the information.

The actual layout is a trial-and-error procedure. It compares the actual distance of the stake to the theoretical calculated distance. The stake distance is then adjusted until the actual and theoretical distances coincide. Different systems are used depending on personal preference.

The difference is the point of reference where the calculated distances are based. The Resident should contact their Supervisor well in advance of needing the slope stakes if training or guidance is needed.

D.3.4.2 Balance Points

A prominent marker should be placed at each earthwork balance point.

D.3.4.3 Curve Superelevation

Review the curve data and typical sections shown on the plans for superelevation rates, transition lengths, and points of rotation. In some instances, this superelevation may create drainage problems, especially in flat terrain and with wide pavements. Review the curve data shown on the plans for superelevation limits and rate.

Superelevation within the limits of villages or cities is designed for the slower speed required and is, therefore, generally less than that found in rural areas where higher speeds prevail. The difference in superelevation is, as a rule, the result of the difference in speeds, although there may be specific instances where good judgment or local conditions call for some modification of our standard practice. If you have any doubt as to whether you should follow the Department's standard practice, discuss the matter with your Supervisor.

E. LAYOUT OF ENTRANCE CULVERTS

E.1 Location

All entrance culverts should be set such that they match the roadway ditch, both line and grade.

E.2 Staking

The only stakes that are necessary to be set for an entrance culvert are two stakes on the centerline of the culvert barrel. On these stakes should be marked with the cut to the ditch flow line.

E.3 Elevation of Headwalls

If headwalls are built, it is essential that the top elevation of the two headwalls be made parallel to the grade of the shoulder, even though the gradient of the ditch is not the same as that of the pavement.

F. LAYOUT OF ACROSS-ROAD CULVERTS

F.1 Location

Prior to staking out an across-road culvert, determine whether the location as shown on the plans will fit the channel to the best advantage.

If you think the culvert line or grade should be relocated or the skew angle changed, take the matter up with your Supervisor. Channel locations should not be revised without approval from your Supervisor.

F.2 Staking

The centerline of the culvert barrel should be staked first by placing a stake on the centerline not closer than 5 feet outside of each headwall. Nails should be set in the stakes giving the exact line. The cut to flow line should be marked on the stake, measured from the top of the stake. Also, always check the plan length for accuracy.

F.3 Elevation of Headwalls

After the forms are built, it is sometimes necessary to set the elevation to be used for the top of headwalls and give the Contactor elevations on the forms at which to set the chamfer. Remember that the tops of the headwalls must be parallel to the grade of the centerline of the roadbed.

G. LAYOUT OF PAVEMENT

G.1 Alignment and Grade

The essentials of a good paving section, alignment, and grade should be kept in mind continually when setting stakes for the work.

G.2 Field Book

Before setting any stakes, you should prepare your field book, check all computed grades shown on the plans, as well as your calculated grades for other points.

If the proposed pavement is to tie into existing pavement, the existing pavement elevations must be checked. Review the District Computer Programs for assistance. In addition to elevations, it is desirable to include the following data in your field book:

- Elevations of each edge of pavement on superelevated curves and on superelevated transitions at ends of curves, at 50-foot intervals;
- Ties to all survey line control points, points of curve and tangent, bench mark elevations, and locations;
- Tables of curve deflection angles and chords;
- Tables of offset from survey line to form stake line when required;
- Your return address (in case book should be lost).

It is a convenience, and will save time, if all necessary information from the plans is carefully transferred to the field book.

G.3 Notes for Setting Grade Stakes and Stringlines for Automatic Grade Control Equipment

Automatic grade control equipment automatically transfers the accuracy of the predetermined plane, such as a stringline, to the subgrade, base, or surface, resulting in a neat line profile.

Automatic grade control equipment makes the transfer by the use of sensing units that contact the stringline on either side of the grade.

Normal Stringline Setting: The Contractor will usually set metal stakes which are 42 inches long and are driven into the ground, normally at 50-foot intervals along one side of the roadway when using a machine equipped with automatic slope control or along both sides of the roadway when using a machine with sensors installed on both the right and left sides of the machine. The metal stakes are set to the hubs (grade stakes set for the roadway) for both dual-lane and single-lane machines. On superelevated sections and ramps, the metal stakes should be set at 25-foot intervals to gain a greater degree of accuracy.

Factors to Consider for Stringline Installation: The following factors should be considered before any preparation for setting the stringline is started, to determine the most feasible location for the stringline:

- Other work that may be performed either between the stringlines, when two are used, or along the shoulders.
- The amount of material to be wasted near the stringline and the disposition that will be made of the material.
- Obstructions along either side of the roadway.
- The limit of the autograde sensor arm supports.
- The percent of fall from the centerline of the roadway to the hubs or edge of pavement.
- The grade stakes should be set directly below the stringline, if possible, but could be offset by up to 4 feet in small areas.

Location of the stringline may vary with each section of the roadway, due to supers, crowns, and offsets. Each section should be evaluated separately to determine the proper location or position of the stringline.

Stringline Hubs. Accurate operation of automatic grade control equipment depends on the correct installation of the stringline and the precise setting of the line and grade hubs. Considerable effort can be saved in the initial engineering if the Resident and Superintendent discuss the proper offset distance of the hubs and the specific machine to be used for each operation.

For autograde equipment with only one grade sensor and an automatic cross slope grade control, only one set of grade hubs is needed. See [Figure 10.5a, page 10-27](#).

For automatic equipment operating from two stringlines, two sets of grade hubs are needed to work the roadway from the initial subgrade to the finished slab. See [Figure 10.5b, page 10-27](#).

Each stringline must be set at a constant distance from the roadway centerline or a theoretical edge of the pavement. Each stringline must also be suspended at a constant height above the plane passing through the lower corners of the proposed slab.

H. COMPUTER APPLICATIONS

The Resident should be aware of and optimize the use of the Department's computer service. The following programs are available at the District level.

H.1 Field Control

Coordinate Geometry: An ICES subsystem capable of solving geometric problems, determining coordinates for triangulation, and locating control points by station/offset values.

Roadway Analysis and Design System: An ICES subsystem capable of computing earthwork quantities, plotting cross sections, and producing printed tables of slope stake locations.

Offset Line Elevations: This program is capable of producing tables of offset line elevations for paving stakes. These tables may optionally be printed on field book size pages.

Circular Curve Deflection Angles: Produces, in tabular form, deflection angles for staking of circular curves in the field.

Three Point Problem: Determines plane coordinates for a point based upon sightings of three non-collinear points whose coordinates are known.

Bridge Deck Elevations: Provides a listing of bridge deck elevations along each beam of a bridge and can adjust these elevations to reflect dead local deflections.

H.2 Field Quantities

Bridge Fillet Quantities: Computes fillet quantities, based upon plan values and field measurements.

Borrow Pit, Embankment, and Excavation Computations: Computes cut and/or fill, along with end-area for each cross section, as well as accumulated totals. Plotting of cross sections is available.

Reinforcing Steel Quantities: Tabulates total weight of reinforcing steel.

H.3 Quality Control

PCC Proportioning: Designs concrete mix for user-specified material and specific gravity.

Bearing Tables for Pile Hammers: Provides a table of bearings versus blows-per-foot. Also computes blows-per-foot to reach a specific bearing.

Slope Stability Analysis Series: These programs analyze the stability of slopes using various test methods.

IV. POST-CONSTRUCTION

A. FINAL MEASUREMENTS

Final measurements for pay quantities should be made concurrently with construction operations where feasible. This procedure results in greater accuracy and reliability. Naturally, some items can only be checked after construction is completed.

A.1 Items Measured During Construction

The following items are examples of those that should be measured immediately after constructed:

- Removal items;
- Sub-cuts;
- Storm sewers;
- Conduit;
- Buried cable; and
- Clearing and grubbing.

A.2 Items Measured After Construction

- Fencing;
- Guard rail;
- Turf establishment;
- Structure length;
- Curb and gutter;
- Sidewalks; and
- Bridge approach panels.

All measurements for final payment made by the survey crew must conform to the requirements in the document "[Standard Specifications for Road and Bridge Construction](#)" adopted January 1, 2012.

A.3 Calculation of Quantities

Final cross sections are used for the computation of final pay quantities. Cross sections should be taken at the same station as the original was taken. This eliminates any need for interpolation of an original at the new station.

Current Method: Average end areas using before and after cross sections.

Note: IDOT is currently working to implement the process of TIN to TIN comparison for computing quantities. The current [IDOT CADD Roadway Drafting Reference Guide](#) should be reviewed periodically to confirm which method to use for quantities.

A.4 Structures

The survey crew should measure drainage structures (catch basins, manholes, etc.) at the time of placement. Final elevations and locations will be required.

A.5 Final Plans

The original plan sheets must be corrected to show any changes and additions made during construction. All corrections or changes shall be noted on the plan sheets. No original details should ever be removed from the plan sheets.

The following list provides some of the information that must be checked, corrected, and added to the original plan sheets:

- Horizontal and vertical control.
- Location, dimensions, and elevations of drainage structures. All of these should be field checked.
- Changes in typical sections.
- Horizontal alignment (including curve changes and control point ties).
- Profile grade.
- All underground units (cable, conduits, pipe, etc.)

B. MONUMENTATION

The construction surveyor should be in charge of as much of the post-construction monumentation as possible.

B.1 Final Alignment

Every effort should be made to monument the final alignment prior to the project being opened to traffic. All PIs shall be monumented, or if inaccessible, the adjoining tangents shall be monumented. P.C.s and P.T.s should be monumented.

B.2 Right-of-Way

The right-of-way should be monumented and marked prior to construction and maintained throughout.

However, if the right-of-way must be re-monumented, it should be done under the supervision of an Illinois Professional Land Surveyor since it involves land surveying.

B.3 Bench Marks

During the course of construction, the bench mark and the temporary bench mark status changes. Many are destroyed and many are established. At the end of the project, a bench list should be made tabulating all remaining bench marks and temporary bench marks.



B.4 Traverse Stations

On projects employing the Illinois State Plane Coordinate System, efforts should be made to perpetuate the control stations after completing construction. All remaining control stations should be shown on the final plan sheets.

F.A. ROUTE 7
SECTION 1-B
PROJECT EB-7-3(3)
LASALLE COUNTY

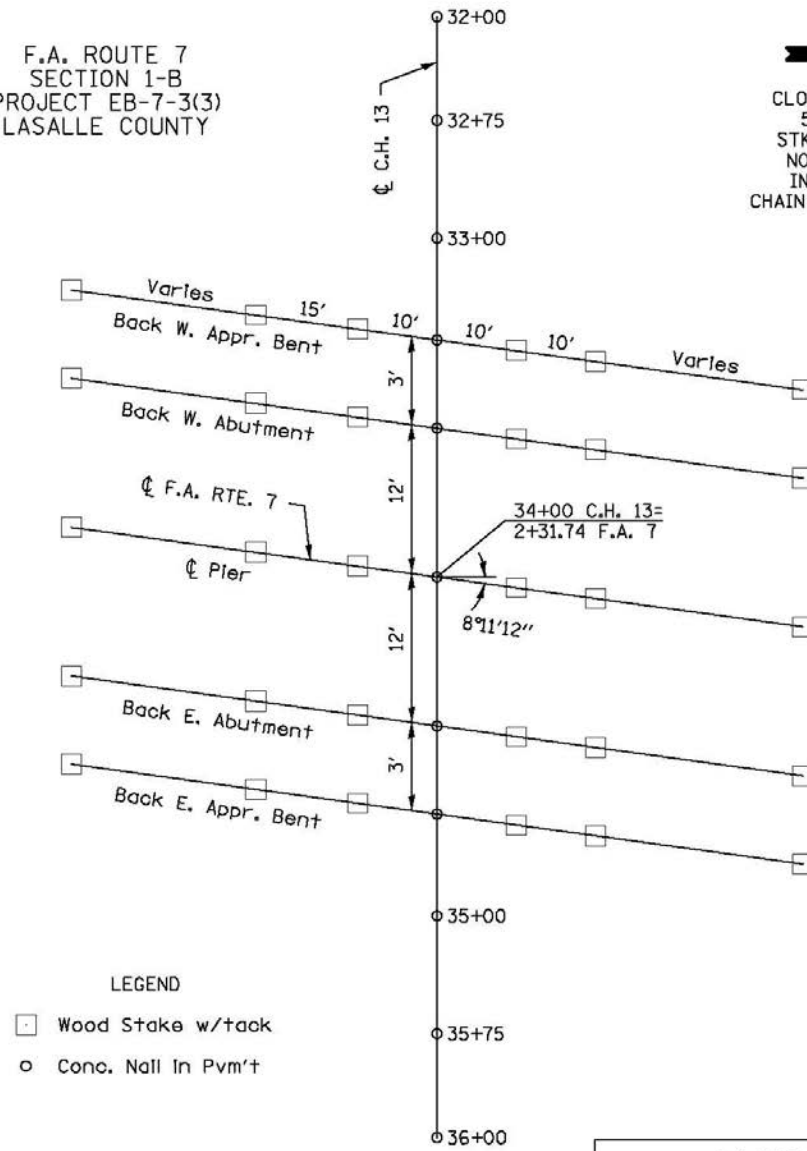
CLOUDY, MUDDY
50°-60° F
STKD 3-1-2014
NOTES J.H.C.
INST. K.A.B.
CHAIN R.W.B., S.J.M.



- LEGEND
-  Wood Stake w/tack
 -  Conc. Nail In Pvm't

CC: Contractor
District Engineer
File

SAMPLE
STAKING DIAGRAM

See file for layout check
By J.C.S. on 3-10-98

Figure 10.1

Figure 10.1

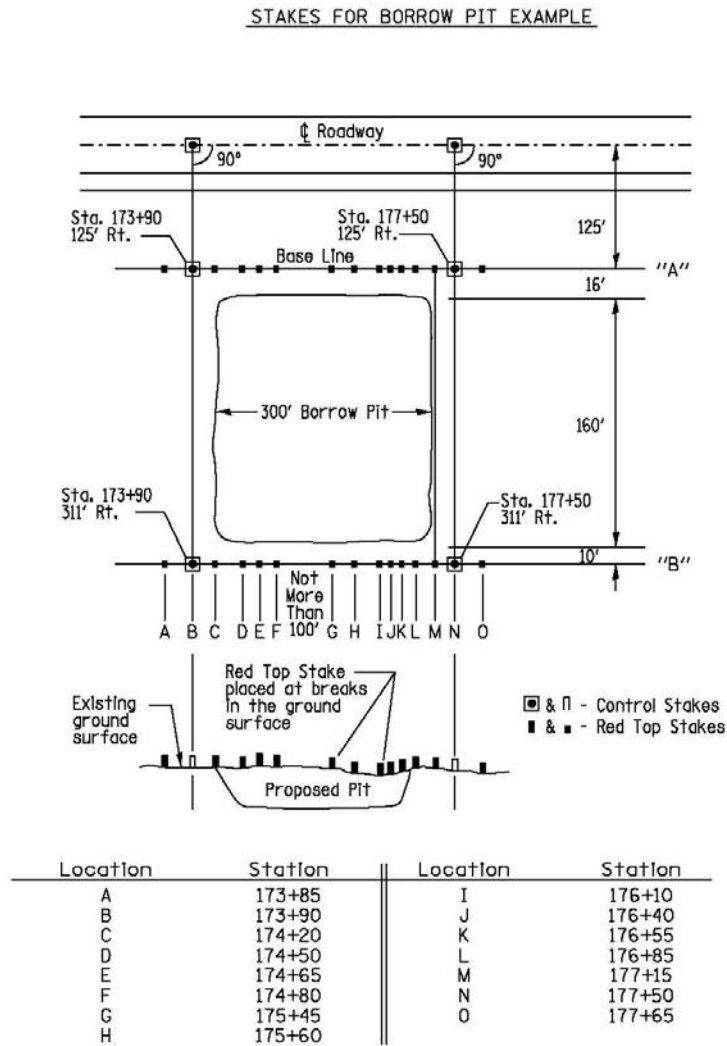

Figure 10.2

Figure 10.2

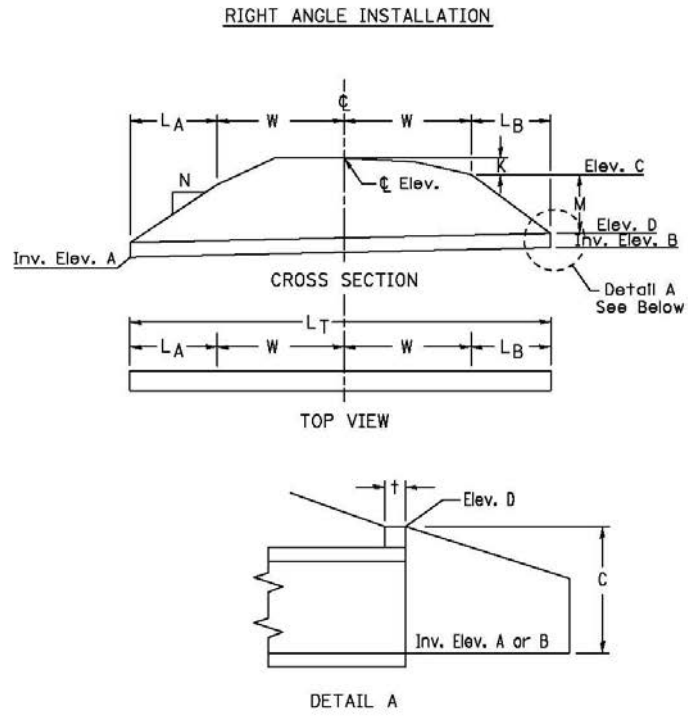

Figure 10.3

Figure 10.3

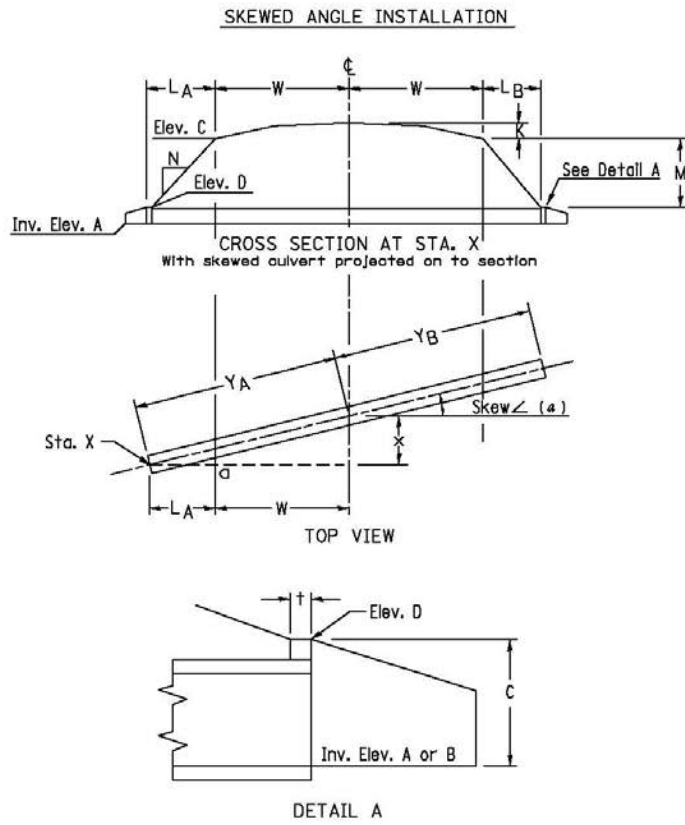
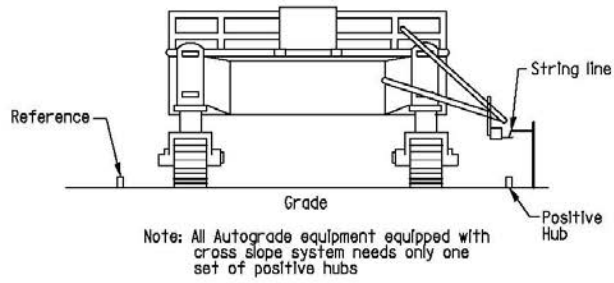

Figure 10.4

Figure 10.4

AUTOGRADE WORKING FROM 1 POSITIVE HUB,
WITH CROSS SLOPE SYSTEM



AUTOGRADE WORKING FROM 2 STRING LINES,
WITH 2 POSITIVE HUBS

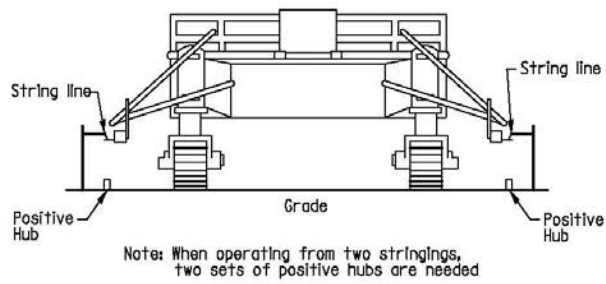

Figures 10.5a and 10.5b

Figures 10.5a and 10.5b

CHAPTER ELEVEN
SUBSURFACE UTILITY ENGINEERING
(SUE)

BUREAU OF DESIGN AND ENVIRONMENT
SURVEY MANUAL

May 2015

CHAPTER ELEVEN

SUBSURFACE UTILITY ENGINEERING (SUE)

Table of Contents

	Page
I. GENERAL INFORMATION.....	11-1
A. Introduction	11-1
B. Benefits of Subsurface Utility Engineering (SUE)	11-1
C. Brief History of SUE	11-2
D. SUE Consultant's Role.....	11-3
E. Definitions / Abbreviations (per CI/ASCE 38-02)	11-4
II. UTILITY DATA COLLECTION	11-5
A. Service Scope	11-5
B. Quality Levels.....	11-5
B.1 Quality Level "D" Services (QL-D).....	11-6
B.1.1 Information Research	11-6
B.1.2 Collection of Utility Records.....	11-6
B.1.3 Records Review	11-6
B.1.4 Information to be Supplied by the Department.....	11-7
B.1.5 Deliverables.....	11-7
B.2 Quality Level "C" Services (QL-C)	11-7
B.2.1 Data Evaluation	11-7
B.2.2 Survey of Surface Appurtenances of the Utilities, Correlation...	11-7
B.2.3 Information to be Supplied by the Department.....	11-7
B.2.4 Deliverables.....	11-8
B.3 Quality Level "B" Services (QL-B)	11-8
B.3.1 Data Research (In Addition to QL-D and QL-C, as Necessary)..	11-8
B.3.2 Field Investigation (In Addition to QL-C, as Necessary).....	11-8
B.3.3 SUE Survey (In Addition to QL-C, as Necessary)	11-9
B.3.4 Information to be Supplied by the Department.....	11-10
B.3.5 Deliverables.....	11-10
B.4 Quality Level "A" Services (QL-A).....	11-10
B.4.1 Project Set-Up	11-10
B.4.2 Non-Destructive Vacuum Excavation and Test Hole Report	11-10
B.4.3 Survey	11-12

B.4.4 Deliverables	11-12
C. SUE Exploration Methods	11-12
D. Advantages of Non-Invasive Vacuum Excavation	11-13
III. ONE-CALL SYSTEMS.....	11-14
A. Illinois One-Call System (JULIE).....	11-14
A.1 Introduction.....	11-14
A.2 Notification Process.....	11-15
A.3 Types of Locate Requests.....	11-15
A.4 Ticket Life.....	11-16
A.5 Excavator Responsibilities.....	11-16
A.6 Facility Owner Responsibilities.....	11-16
B. The City of Chicago One-Call Network (DIGGER).....	11-18
IV. UTILITY COORDINATION.....	11-18
A. General Description.....	11-18
V. CONCLUSION.....	11-19

CHAPTER ELEVEN

SUBSURFACE UTILITY ENGINEERING (SUE)

I. GENERAL INFORMATION

A. INTRODUCTION

Subsurface Utility Engineering (SUE) is a branch of engineering practice that manages risks associated with underground utilities. It involves utility mapping at appropriate quality levels, utility coordination, utility relocation design and coordination, utility condition assessment, communication of utility data to concerned parties, utility relocation cost estimates, implementation of utility accommodation policies, and utility design.

The Department has formally adopted SUE and uses the [American Society of Civil Engineers \(ASCE\) National Standard CI/ASCE 38-02](#) in the collection and depiction of utility data. This Chapter supplements that document.

B. BENEFITS OF SUBSURFACE UTILITY ENGINEERING (SUE)

The benefits of SUE were first fully documented in a [Purdue University study](#) of 71 highway projects in states with extensive utilization of the SUE process. The often-quoted study was published in the year 2000 and it quantified a total of \$4.62 in avoided costs for every \$1.00 spent on SUE services. The researchers also established that the qualitative savings were even higher. SUE was proven to be an excellent tool for reducing the project costs and minimizing risks associated with existing subsurface facilities.

Federal Highway Administration materials enumerated benefits obtained from proper and successful application of the SUE process including, but not limited to:

- Protection of property and public health
- Prevention of damages to utilities and the environment
- Prevention of service disruptions and expensive repairs
- Reduction in construction delays due to utility conflicts
- Reduction of the project design cost
- Reduction of the redesign cost due to utility conflicts
- Reduction in right-of-way acquisition costs
- Increased accuracy of project bids
- Reduction in project contingency fees
- Facilitation of electronic mapping accuracy
- Minimization of travel delay and traffic disruptions
- Inducement of savings in risk management and insurance

C. BRIEF HISTORY OF SUE

Subsurface utility engineering was a term virtually unknown in the civil engineering business before the late 1970s. Projects were often designed without detailed information ascertaining the exact position of underground facilities or even their presence at the construction site. With no confirmed data available, it was also extremely difficult to estimate cost associated with adjustment or removal of unknown utility lines. Use of heavy equipment often resulted in risk of damages, service disruptions, unforeseen project delays, and sometimes in injuries and loss of life.

It was only in the early 1980s when the building industry started using a technique called air/vacuum excavation to explore underground structures prior to the construction phase. This new method would expose subsurface facilities in a non-invasive manner in order to assess their elevation, type, size, condition, and other specific attributes. At that point, new surface geophysical equipment was also introduced to help determine approximate horizontal position of the utilities.

The advantages and the overall value of utility exploration had gradually become apparent to state transportation departments, local agencies, utility companies, and design consultants. The Virginia Department of Transportation was leading the way; it became the first state agency regularly using non-destructive methods in utility explorations and surveys. Transportation departments in other states soon followed by making search for utilities a routine requirement on their projects.

It was during that period of time when the terms "designating" and "locating" were first coined to distinguish the horizontal search for utilities using surface geophysics from vertical exploration utilizing air/vacuum excavation. By the end of the 1980s, a process called Subsurface Utility Engineering (SUE) evolved into a full-scope professional practice including civil engineering design, geophysical and non-invasive exploration technologies, and surveys. AutoCAD and new data management systems were also introduced during that time frame. The Federal Highway Administration (FHWA) began actively promoting the use of SUE a few years later and more and more SUE consultants and contractors started to provide that service in a number of states.

In 2003, the American Society of Civil Engineers (ASCE) published the national standard [CI/ASCE 38-02](#) ("Standard Guideline for the Collection and Depiction of Existing Subsurface Utility Data"). The standard enumerated quality requirements pertinent to collection of existing subsurface utility information in the field and its depiction in design documents. It spelled out responsibilities of project owners, designers, and contractors while putting in place terminology and definitions now common throughout the SUE business.

D. SUE CONSULTANT'S ROLE

A SUE consultant is expected to provide a well-rounded service package including document research, horizontal/vertical exploration of private and public underground utilities, SUE surveys, CADD documentation of the collected data, and certification of deliverables prepared in the desired format and detail.

The SUE proposal needs to address project-specific requirements and the type of deliverables desired. The accuracy of the information provided must meet or exceed the ASCE standard requirements.

The Department expects efficiency, cost-effectiveness, responsiveness, and Quality Assurance and Quality Control to be included in the SUE process. Since the SUE exploration often is immediately followed by important activities performed by others, meeting the requested deadlines is crucial.

As documented by CI/ASCE 38-02, a SUE consultant is required to take care of a variety of specific tasks:

- Support the Department in its responsibility to take all of the appropriate actions in considering and dealing with utility risks.
- Designate and/or locate utilities during the design or bidding phases of a project, when One-Call System services are not available or are too time consuming to obtain.
- Perform services on both public and private lands where existing utility information is often incomplete, out of date, or inaccessible.
- Assess utility condition using non-destructive excavation methods.
- Designate, survey, and document new utilities installed by the contractor in form of “As Built” drawings required by the Department.
- Use highly trained personnel, special techniques, and state-of-the-art equipment that may not be readily available.

The SUE consultant is also expected to communicate and process large amounts of data in a concise, efficient, and timely manner and to advise others how to take full advantage of the accuracy and completeness of the utility information provided.

E. DEFINITIONS / ABBREVIATIONS (PER CI/ASCE 38-02)

Attribute: A distinctive documented characteristic of a utility that includes, but is not limited to, elevation, horizontal position, configuration, shape, size, material, condition, age, etc.

Depiction: Visual image of existing utility information on project plan sheets.

Designating: Process of using a surface geophysical method to interpret the presence of a subsurface utility and to mark its approximate horizontal position on the ground. Please note that some tend to refer to this process as “locating” while it actually pertains to QL “B” activities.

Geographic Information System (GIS): An electronic system designed to capture, analyze, store, manipulate, display, and manage various types of geographical data.

Ground Penetrating Radar (GPR): A non-destructive geophysical method using radar pulses to image the subsurface features.

Locating: Process of exposing a utility by using minimally intrusive excavation method(s) and surveying and recording its precise vertical and horizontal position.

Subsurface Utility Engineering (SUE): A branch of engineering practice that involves utility exploration and mapping at appropriate quality levels.

Utility: A privately, publicly, or cooperatively owned and/or operated line, facility, or system for producing, transmitting, or distributing materials, energy, information, and/or other commodities.

Quality Level: CI/ASCE 38-02 describes four methods of utility data collection and interpretation.

Utility Quality Level "A": Precise horizontal and vertical location of utilities obtained by the actual exposure (or verification of previously exposed and surveyed utilities) and subsequent measurement of subsurface utilities, usually at a specific point.

Utility Quality Level "B": Information obtained through application of appropriate surface geophysical methods to determine the existence and approximate horizontal position of subsurface utilities.

Utility Quality Level "C": Information obtained by surveying and plotting visible above-ground utility appurtenances and by using professional judgment in correlating the information to Level "D" data.

Utility Quality Level "D": Information derived from existing records or oral recollections.

Utility Search: Search for a specific or unknown utility within a defined area, using a level of effort in accordance with the specified Quality Level.

Utility Trace: Process of using surface geophysical methods to image and track a utility.

II. UTILITY DATA COLLECTION

A. SERVICE SCOPE

As significant portions of the SUE exploration and mapping activities are performed in the field, public safety and protection of life and property is paramount.

The following description reflects the standard CI/ASCE 38-02 service scope ensuring accuracy and completeness of the collected data on all four Quality Levels.

B. QUALITY LEVELS

B.1 Quality Level "D" Services (QL-D)

B.1.1 Information Research

- Conduct utility records research to assist in identifying utility owners who may have facilities at the project site and/or whose operations may be affected by the project. Sources of information may be: state, city, and county agencies; One-Call notification centers (JULIE, DIGGER); project designers; project owners; landlords; tenants; surveyors; utility owners; and/or internet databanks.
- Establish preliminary understanding of the project scope and limits, site access, and of the planned project activities to be conducted by others.
- Visit the site and conduct inspection of visible utility appurtenances and other features present within the project limits or adjacent to the site.
- Take field measurements and/or photographs/videos, as appropriate and permitted.

B.1.2 Collection of Utility Records

Collect and organize existing utility information included in, but not limited to: designer's project data; previous construction drawings; "As Built" and other record documentation; utility maps; topographic/boundary surveys depicting utility appurtenances; direct-burial cable records; distribution and transmission maps; service and maintenance records; field notes; circuit diagrams; utility data included in Geographic Information Systems (GIS); site facility drawings; and oral recollections.

B.1.3 Records Review

- Review the collected utility records for indication of a need to conduct additional research/data collection, for duplicate information and its credibility, and for apparent contradictions that may have to be explained or clarified.
- Use professional judgment regarding the validity and location of topographic features shown on the obtained records and conflicting references of utilities.

- Develop utility composite drawings (or equivalent) depicting the obtained utility information including its quality levels, utility types, and ownership; date of depiction; accuracy of the depicted appurtenances; and end points of any utility data, as well as function, size, condition, and status of the utility (e.g., active, abandoned in place, out-of-service).

B.1.4 Information to be Supplied by the Department

See the above description, as applicable.

B.1.5 Deliverables

Provide utility composite CADD drawings (or equivalent) depicting the obtained utility information and copies of documentation, as researched, collected, and reviewed. The number of hard copies and specifics of an electronic submittal (if applicable) will be determined by the Department prior to commencement of the project.

B.2. Quality Level "C" Services (QL-C)

B.2.1 Data Evaluation

- Perform tasks included in the QL-D as necessary (QL-D and QL-C tasks do not necessarily need to be performed in any prescriptive order).
- Identify surface appurtenances of existing underground utilities as depicted in the obtained QL-D documentation.

B.2.2 Survey of Surface Appurtenances of the Utilities, Correlation

- Field-survey surface appurtenances of underground utilities within the project area. If previously surveyed by others, check accuracy and completeness for data applicability.
- Correlate utility records to the surveyed features, considering their geometries and depiction.

B.2.3 Information to be Supplied by the Department

- Existing topographical/boundary survey including requested horizontal and vertical datum, to be used in preparation of the QL-C SUE drawings.

- CADD/Base Mapping.
- Layer structure, symbols library, line types/color to be utilized, and format for field report(s).

B.2.4 Deliverables

Provide CADD drawings showing the QL-D information and depicting QL-C data surveyed. The number of hard copies and specifics of the electronic submittal will be determined by the Department prior to commencement of the project.

B.3 Quality Level "B" Services (QL-B)

B.3.1 Data Research (In Addition to QL-D and QL-C, as Necessary)

- Identify and contact appropriate agencies for data related to underground utilities present within the project limits.
- Conduct a thorough investigation of available records, plans, drawings, plats, and/or mappings.
- Establish preliminary understanding of the amount, type, size, and material of utilities and structures located in the field.
- Use the collected materials to generate a composite utilities plan for use in coordinating and checking field designations.

B.3.2 Field Investigation (In Addition to QL-C, as Necessary)

- Conduct a thorough search of the site for buried utilities, pipes, wires, and cables which are indicated on available records.
- Verify that each indicated structure has been located or otherwise accounted for.
- In addition to locating the known utilities, sweep the site areas or routes specified in search for utilities and structures which may not appear on the available records, but where surface evidence indicates the potential. Unless directed by the Department, a 100% coverage sweep of the project limits is not required.
- Attempt to determine the identity of each undocumented structure discovered by conducting further records research.
- Use electromagnetic, sonic, geophysical, vibratory, and/or other techniques deemed necessary or appropriate by the project team personnel.

- Determine the approximate horizontal location of existing buried utilities, cables, duct banks, mains, conduits, pipelines, service laterals, and other structures of interest within the project limits as accurately as the current state-of-the-art technology and techniques allow.
- Adhere to the current industry standard accuracy of 18 inches, measured each way from the edge of the located object plus its diameter or width.
- Generate field sketches detailing the approximate location of all explored and marked buried utilities, pipes, wires, cables, and structures.
- Indicate the type, size, material, and owner of the buried lines, if information is known.
- Indicate the color or marking method of each utility in the sketch to enable efficient SUE survey of the located utilities and structures.
- Mark utilities and structures in a clear, readily identifiable manner both at their straight runs and at every bend, tee, wye, and dead end, or at any other significant feature or change in direction of the utilities.
- Use the sufficient number of markings needed to accurately show the location and trend of the utility. Mark parallel utilities in proper sequence.

B.3.3 SUE Survey (In Addition to QL-C, as Necessary)

- Survey utility markings and utility appurtenances (valves, manholes, hydrants, pedestals, transformers, etc.) for transfer to the base plan provided electronically by the Department.
- Reference survey data to the same coordinate system as the current CADD mapping of the project area using existing control points for each of the areas being surveyed.
- Use GPS survey method as appropriate and practical (and as per project requirements).
- Generate preliminary CADD drawings to be checked for accuracy in the field and to be compared to all field sketches, records, composite drawings, plans, and other information available for discrepancies and omissions.
- Resolve all conflicts, finalize drawings, and generate a written report of any special conditions or unusual findings.

- Indicate utilities on the drawings in a consistent format. Each type of utility is to be labeled on the plans as to its type, size, and material or construction, using information ascertainable to a reasonable degree of accuracy.

B.3.4 Information to be Supplied by the Department

- Existing or requested Horizontal and Vertical Datum.
- CADD/Base Mapping.
- Layer structure, symbols library, and line types/color to be utilized.
- Format for field report.

B.3.5 Deliverables

Provide CADD drawings showing all existing major utilities mapped. The number of hard copies and specifics of the electronic submittal will be determined by the Department prior to commencement of the project.

B.4 Quality Level "A" Services (QL-A)

B.4.1 Project Set-Up

- Obtain necessary permits and properly notify utility companies via One-Call notification centers (JULIE, DIGGER, and other agencies), prior to commencement of excavation.
- Confirm accessibility of the site.
- Provide necessary traffic control in accordance with the [Manual of Uniform Traffic Control Devices](#), if applicable and required.
- Determine the precise location for each test hole, based upon the approximate test pit location, shown on project plans, or verify the location by horizontal exploration on the QL-B.

B.4.2 Non-Destructive Vacuum Excavation and Test Hole Report

- If the test hole is to be constructed in existing asphalt/concrete pavement, use core drilling equipment to create an 18-inch diameter opening. Preserve the core for a later use.
- Record the thickness and materials of the base/sub base pavement.
- Excavate the test hole using a high-pressure air lance and vacuum through a 12-inch square or 18-inch diameter opening in the ground surface to expose the utility in question. The Department at present prohibits the use of water (hydro) vacuum excavation techniques.

- The Department may on a case-by-case situation allow the limited use of a water lance.
- Reference the test hole to physical features on the plan, or provide X, Y, and Z coordinates on the datum to a reference marker placed at the test hole location. The marker is to be located next to the actual test hole and over the center of said utility (the marker is to be located in the center of the backfilled test hole if direction of the utility could not be established).
- Provide vertical measurement (elevations) for the existing grade at the test hole and top of the utility located. Elevations will be based upon bench marks provided by the Department. It is assumed that existing bench mark data will be within the limits of the project site.
- Record the dimensions of the existing utility. If the existing utility is a circular pipe, provide the outside diameter. If the existing utility is rectangular in shape (e.g., concrete duct bank), provide outside dimensions for its height and width. Record all visible features of the utility (i.e., joints, pipe materials, bedding, etc.). Take digital photographs of the utility and the test hole location. Record time, location, and direction of the view.
- If the test hole is in existing pavement, record the thickness and materials of the base/sub base pavement.
- Backfill the test hole using the soil previously removed, unless required otherwise. Achieve compaction by tamping throughout the backfill process.
- Replace asphalt/slab to its original thickness and to the required specifications.
- If core drilling was used to create an opening in the pavement, re-install the core into a bed of high-strength bonding compound. Use additives for faster setting times in low temperatures.
- Establish ties and measure position of the test hole marker in relation to three (3) adjacent prominent features located in vicinity of the test hole.
- Depict all the collected information including description of the utility appurtenances, elevation, horizontal position (ties), etc., in a QL-A field form/sketch.

B.4.3 Survey

- Survey the test hole marker and reference survey data to the same coordinate system as the current CADD mapping of the project area while using existing control points for each of the areas being surveyed.
- Use GPS survey method as appropriate and practical (and as per project requirements).
- Prepare a certified test hole report (CADD) indicating all the pertinent data gathered.
- Cross-reference the QL-A and QL-B utility information depicted (if documentation for both quality levels is requested).
- Use the required QA/QC process for finalizing the information and submit the QL-A documentation sealed/stamped by the Licensed Surveyor/Engineer directly involved in the project, as directed by the Department.

B.4.4 Deliverables

Provide test hole reports/drawings in CADD format showing the existing utilities located. The number of hard copies and specifics of the electronic submittal will be determined by the Department prior to commencement of the project.

C. SUE EXPLORATION METHODS

Significant advances in the computer science have enabled SUE professionals to collect, process, and manage utility data with speed and efficiency greatly improved from only a few years back. The advanced radar tomography (RT), global positioning system (GPS), and the geographic information system (GIS) are now used on regular basis. These and other revolutionary technologies are key to successful and cost-effective utility mapping.

As noted in the CI/ASCE 38-02 standard, the effectiveness of the applied geophysical methods still depends on many factors, including the material, size, and function of the utilities. The accuracy may be further influenced by proximity of adjacent underground and surface facilities, and their energy fields. The type and conductivity of the soil, as well as the type and smoothness of the surface, noise, and ambient temperature may also play a role.

There are significant differences in techniques and the equipment used to search for a utility's presence, and for tracing a utility's path. According to CI-ASCE 38-02, various SUE exploration methods could be applied by experienced field personnel in order to achieve the desired results:

- Pipe and Cable Locators are used for utilities creating and transmitting a signal or are induced by the transmitter to create their own magnetic field. The signal is introduced either by a direct attachment to the surface appurtenance of the utility, or through the ground.
- Metal Detectors transmit AC magnetic field inducing eddy currents in metallic objects and interact with the search coil of the equipment. They are typically used for detection of valve boxes, corner markers, PK nails, steel pipes, or buried manhole covers.
- Electrical Resistivity Measurement methods involve injecting DC current into the ground at two or more electrodes and measuring resultant voltage at other electrodes ("four-pin method"). They are used in hydrogeological and environmental explorations.
- Ground Penetrating Radar (GPR) sends a microwave pulse in the ground and measures the reflection received back at the ground surface. GPR uses frequencies of 10-1,000 MHz.
- CART (Computer Assisted Radar Tomography) method provides 3D imaging data.
- Optical methods operate on visibility of light introduced into utilities.
- Sound (Elastic Wave) methods measure sound introduced into the utility (Active Sonics), sound created by leaks (Passive Sonics), or sound created by a wave (Resonant Sonics).
- Chemical methods may detect a chemical signature of materials used for the construction of utilities. Also, a leak may be detected by introducing odorant into the utility.

D. ADVANTAGES OF NON-INVASIVE VACUUM EXCAVATION

Non-Invasive Vacuum Excavation is usually used in combination with other geophysical methods and/or when all other methods fail to deliver the desired results. It can be effectively implemented in a variety of situations in order to provide Utility Quality Level "A" (QL-A) accuracy as follows:

- Remote vacuum excavation prevents damage to building facilities, sidewalks, and landscaping.
- It is performed to expose unmarked and undocumented utilities.

- It is used to expose utility lines with no trace wire, utilities with no known access points, and underground facilities not detectable by standard exploration methods.
- It replaces time-consuming and potentially unsafe hand digging in frozen ground performed with the goal of exposing unprotected communication cables.
- It is conducted in close proximity of high-voltage power distribution lines.
- It is a preferred method for uncovering lines whose exact vertical position could not be confirmed by electronic exploration, as their signature was masked or distorted by other utilities.
- Vacuum excavation is also used for excavation of trenches in areas of heavy utility congestion.

III. ONE-CALL SYSTEMS

A. THE ILLINOIS ONE-CALL SYSTEM (JULIE)

A.1 Introduction

The Illinois One-Call System is also known as JULIE (Joint Utility Locating Information for Excavators). It is a non-profit organization that receives information about planned excavations from contractors and homeowners and distributes it to utility owners and operators. JULIE does not own any underground utilities and it does not perform any field services; it only serves as a communication link utilized for public safety and protection of underground utilities and facilities.

JULIE was created under the [Illinois Underground Utility Facilities Damage Prevention Act \(220 ILCS 50/\)](#). It began its operations in 1974 and it now provides services throughout the entire state of Illinois, with the exception of the City of Chicago which operates its own One-Call system. JULIE's services are funded by member utility companies and operators.

The following descriptions are intended for orientation and reference purposes only. They are not intended to be a full and complete statement of the said Act, or serve as a replacement for the [JULIE Excavator Handbook](#) information used in the following paragraphs.

A.2 Notification Process

Illinois law requires that anyone planning any type of excavation provides advance notice to utility owners and operators. The notification process involves contacting JULIE with a locate request and distribution of that request to utility owners and operators by JULIE, as follows:

1. The excavator/home owner contacts JULIE by calling 811 or 1-800-892-0123; online via an E-request at www.illinois1call.com; or via Remote Ticket Entry (RTE). It is required that “only the excavator or a personal representative/employee of the company engaging in the excavation activity” makes the contact. In certain cases, a homeowner would be allowed to serve as the contractor's agent.
2. The information required for a locate request is to include, at minimum, the person's name and contact information; the start date and time of the planned excavation; the exact address of the site; and other information pertinent to the location, depth, type, and method of the excavation.
3. JULIE processes the information, provides a dig number unique to the specific locate request received, and shares it with the caller. It distributes the request to the owners and operators of the utilities/facilities present in the excavation area in the form of a “ticket.”
4. The utility owners/operators receive the ticket and dispatch their representatives or agents to the site to locate/mark their utilities within the scope of the ticket and the prescribed time frame.

A.3 Types of Locate Requests

The JULIE system can receive and process locate requests as follows:

Normal Locate Request is a request requiring 48 hours/2-business day notice. Since 2013, the extent of the request is limited to ¼ mile within a municipality and 1 mile in an unincorporated area.

Emergency Locate Request is defined as a request related to any condition presenting an imminent danger to life, health, property, or a utility service outage. This type of request requires a 2-hour notice.

No Show Request is a request initiated by an excavator when previously notified utility owners/operators fail to mark their utilities before the requested start date and time.

Incomplete Request is a request reserved for a failure to completely locate/mark utilities within the scope of the ticket identified by the excavator in a prior notice.

Re-Mark Request is a request to restore utility marks that became indistinguishable or were destroyed by weather, construction activities, or vandalism.

Joint Meet Request is a request initiated for the purpose of scheduling a site meeting in which representatives of utility owners/operators discuss complicated projects and share all the utility information available to them. A Joint Meet request results in a 96-hour/4-business day notice.

Design Stage/Planning Information Request is placed by architects and designers who seek the utility information for their design and project planning purposes. The utility owners/operators should respond to this type of a request within 10 working days by providing their utility drawings or marking the utilities at the proposed project site. Some utility owners may charge a fee for that service.

A.4 Ticket Life

According to the Act, a ticket is valid for 28 calendar days only. If the excavation project extends past that time frame, the excavator must provide a notice through JULIE to obtain an extension for an additional 28 calendar days.

A.5 Excavator Responsibilities

According to the Act, the contractor shall pre-mark the site with white paint to outline the extent of the planned excavation prior to contacting JULIE. Black paint is to be used when snow is on the ground. Verbal pre-marking is valid only if a clear reference can be made to an existing and visible surface structure that is to be demolished or replaced. A radius of excavation around said structure should be specified at the time of the locate request.

The excavator is responsible for proper notification of JULIE prior to the excavation. The information given to JULIE must be concise and accurate. Submittal of a wrong address and/or site coordinates, mistaken municipality or county, erroneous scope of the ticket, or incomplete contact data must be prevented regardless of the circumstances.

The excavator shall follow proper excavation procedures and exercise extra care and caution when working within the utility tolerance zone defined as a strip of land at least 3 feet wide, but not wider than 1-1/2 feet on either side of the utility, based on the utility markings.

The excavator shall not start the excavation prematurely, i.e., prior to completion of the markings, or excavate on an expired ticket. The excavator also shall not ignore the need of No Show, Incomplete, or Re-Mark requests, and exercise reasonable business practices while interacting with utility locators.

In the event of damage to an underground utility, the person responsible for the excavation or demolition “shall immediately notify the affected utility and JULIE and cease excavation in the area of the damage when the damaged facility is a threat to life or property or if otherwise required by law.” The Act also stipulates that the person responsible for the excavation or demolition “shall not attempt to repair, clamp, or constrict the damaged utility facility unless under the supervision or advisement of the utility facility owner or operator.”

The excavator or homeowner should not contact JULIE to report any service outage, to resolve billing problems, or to request facility removal, relocation, and/or initiation of any type of utility service. These inquiries need to be addressed directly with utility owners/operators, instead.

A.6 Facility Owner Responsibilities

The utility owner/operator representatives or agents are to respond to the locate requests assigned to them within the time frame and scope identified by the ticket. They are required to mark their utilities in a manner consistent with the applicable sections of the CI/ ASCE National Standard 38-02. The utilities must be marked in accordance with the approved APWA color codes.

If the utility owner/operator does not have any utilities in the immediate excavation area, he needs to communicate that information to the excavator in a face-to-face meeting, via phone or fax, and by posting or marking the excavation area with "OK" and the utility company initials.

The utility owner/operator representatives or agents are required to locate only the utilities they own, operate, or maintain. They are not required to locate or mark utilities/facilities installed and owned by private entities, e.g., service lines extending from the property line (or easement) to privately owned facilities. A private utility locator may have to be hired for that purpose.

B. THE CITY OF CHICAGO ONE-CALL NETWORK (DIGGER)

The City of Chicago One-Call Network is a non-profit organization also known as DIGGER (Chicago Utility Alert Network). **DIGGER** was created in 1974 by owners and operators of underground utilities in the City of Chicago in an effort to prevent and minimize damages and service disruptions.

While the DIGGER system is active only within the Chicago city limits, its operations closely mirror those performed by JULIE on a statewide basis. This applies to the process of receiving and processing locate requests and transmitting them to utility owners/operators and the City utility departments. It also applies to the roles and general responsibilities of all the parties involved as well as to the specific requirements of timeliness, accuracy, and safety.

The DIGGER system is currently being re-designed to streamline the utility locate request and marking process and to further its effectiveness. A 2014 release was anticipated.

IV. UTILITY COORDINATION

A. GENERAL DESCRIPTION

Utility Coordination can be described as an effort associated with adjustment of existing utility facilities that are in conflict with a highway improvement project. It involves activities related to relocation or removal of existing utilities by a utility company, performed under a Utility Agreement between the utility company and the State that defines the scope, reimbursement, and schedule of said activities.

The utility adjustment procedures and policies are based on the Federal Highway Administration requirements and applied both to IDOT's federally funded and non-federally funded projects. They are documented in detail in Chapter 6 of the [Illinois Bureau of Design and Environment Manual](#).

V. CONCLUSION

Today, utility exploration and mapping processes are utilized by a wide variety of entities in most of the United States. SUE has been used by municipalities, public agencies, utility companies, and transportation departments, as well as by other state authorities and the federal government.

Utility owners and developers now routinely benefit from SUE at projects conducted on private lands. A/E design firms strive to ensure that utilities (regardless if active, abandoned, or unknown) are explored, identified, and their attributes are properly depicted in the project documentation. They realize that inaccurate, incomplete, and/or out-of-date utility information reduces the quality and completeness of their designs.

Utilization of SUE, combined with proper excavating procedures, also helps contractors in their efforts to increase productivity, maintain safety, and manage risks associated with their construction activities.

CHAPTER TWELVE

SAFETY

BUREAU OF DESIGN AND ENVIRONMENT
SURVEY MANUAL

May 2015

CHAPTER TWELVE

SAFETY

Table of Contents

	Page
I. INTRODUCTION	12-1
II. PERSONNEL.....	12-1
A. Chief of Surveys Responsibilities.....	12-1
B. Crew Chief Responsibilities	12-2
C. Crew Member Responsibilities	12-2
III. GENERAL SAFETY REQUIREMENTS	12-3
A. Safe Driving Practices	12-3
B. Safe Surveying Practices	12-4
C. Accident Reporting	12-4
IV. FIELD ACTIVITIES	12-5
A. Proper Handling and Care of Hand Tools	12-5
B. Confined Spaces	12-6
C. Personal Protection	12-6
D. Water Operations	12-8
E. Truck Use and Handling.....	12-8
V. TEMPORARY TRAFFIC CONTROL.....	12-10
A. General	12-10
B. Individual Safety.....	12-12
C. Short Term Encroachment on Pavement.....	12-12
D. Work Site Protection	12-12
D.1 Advanced Warning Signs.....	12-13
D.2 Traffic Cones	12-14
D.3 Flaggers	12-14
D.4 Lookouts.....	12-16
E. Equipment.....	12-16
F. Placement of Signs and Cones	12-17
G. Removal of Control Devices	12-17
H. Closures.....	12-17
I. Stationary Lane Closure	12-18
J. Centerline Surveys	12-19
K. Strobe Warning Lights and Emergency Flashing Lights	12-20
K.1 General	12-20

K.2.1 Daytime Use..... 12-21
K.2.2 Nighttime Use..... 12-21
K.2.3 Additional Considerations..... 12-22
VI. REFERENCES 12-24

CHAPTER TWELVE

SAFETY

I. INTRODUCTION

The employees of the Illinois Department of Transportation survey in many different environments. Many of those are hazardous, such as: rugged terrain, high-speed traffic, tools used, construction equipment, poisonous vegetation, and snake-infested areas.

The objective of this Chapter in the Surveying Manual is to help maintain maximum output of manpower, equipment, and supplies by eliminating accidents resulting in lost time, personal injury, property damage, and human suffering. For the most recent information on the Department's Safety Code, see <http://www.ediillinois.org/ppa/docs/00/00/00/03/47/52/EmployeeSafetyCode2010.pdf>.

It shall be the duty of every employee to consider no job so important and no service so urgent that time cannot be taken to work and drive safely.

The violations of Department safety rules and practices have resulted in injury to employees, damage to Department equipment and lawsuits; therefore, the failure of supervisory and/or non-supervisory employees to comply with safety rules and practices outlined in this Chapter may result in disciplinary action.

II. PERSONNEL

A. CHIEF OF SURVEYS RESPONSIBILITIES

It shall be the responsibility of every Chief of Surveys to carry on the operation under their jurisdiction in such a manner as to provide safe conditions/practices for all employees and the public.

The Chief of Surveys should provide each new employee with a copy of this Chapter of the Survey Manual and allow him/her time to read and study it. Be certain the employee understands the contents of this Chapter. Each employee must understand the need for being responsible for his own safety and the safety of others.

The Chief of Surveys should have at least one person trained in first-aid on each survey crew. Assign other trained personnel to crews working on jobs that require hazardous tasks, such as: working in confined spaces; keeping highly allergic personnel away from jobs where poison ivy, poison oak, or other toxic vegetation or

substances cannot be avoided; or providing places where antivenin can be administered professionally for employees working in a high snake hazard area.

The Chief of Surveys shall monitor and immediately correct safety deficiencies that are seen or reported on job sites. They shall see that adequate safety equipment is stocked.

B. CREW CHIEF RESPONSIBILITIES

The Crew Chief has the responsibility to implement the Department-approved work methods and procedures to ensure that all work is performed safely.

He/she should:

- See that a copy of this Chapter on safety issues is always available to members of the crew. A copy should be kept in each survey vehicle.
- Give safety a first priority when planning each survey.
- Request enough personnel to allow for safe surveying practices to be followed.
- Provide a buddy on the task to help ensure the safety of the employee while working in hazardous areas, such as: around animals (wild or domestic), crossing fences, precipitous slopes or slippery rocks, working in venomous snake areas, and around power lines.
- Make sure that the crew has the proper safety equipment available for their use.
- Make sure the employees use the equipment as required.
- Not let the employee work if an employee refuses to use the required equipment.
- If need be, report him/her to your supervisor.
- Make certain that all equipment and supplies are safe to use. He/she shall make certain that all new employees have been fully trained in the safety issues covered in this Chapter of the Manual.

C. CREW MEMBER RESPONSIBILITIES

Every IDOT employee is responsible for his own safety and the safety of his co-workers. During field operations the crewmember should:

- Report any unsafe conditions or practices.
- Promptly report all accidents and personal injuries to his/her supervisor.
- Be alert for hidden hazards.

- Store and secure all equipment and supplies when not in use.
- Set aside defective and unsafe tools and supplies.
- Help in keeping all work areas clean, sanitary, and litter free.
- Always face oncoming traffic when working on foot and near or on the traveled way.
- Steel toed shoes are required (see the [Employee Safety Code](#), Part I, Chapter 5, Section 4 on Foot Protection).
Wear clothing that will keep you from being injured or diverted from safely performing the job at hand.
- Each employee shall wear a State-issued soft reflective hat or hard hat and a reflective vest whenever the situation calls for their use. See [Section IV.C](#), Personal Protection on [page 12-6](#), for more details.

III. GENERAL SAFETY REQUIREMENTS

A. SAFE DRIVING PRACTICES

Employees are not exempt from traffic laws. Employees operating vehicles and mobile equipment shall obey all State and Local Traffic Laws and Department Policies, Rules, and Regulations.

The number of employees permitted to ride in a car, truck, or mobile equipment shall not exceed the seat space and seat belts as provided by the manufacturer.

Safety seat belts installed in vehicles and mobile equipment shall be used by the operator and passengers while the vehicle or mobile equipment is in use, except for equipment/operations which require the operator to stand to safely perform the work. The operator shall not place the vehicle in motion until all occupants have properly secured their safety belts.

It is the operator's responsibility to report all vehicle and equipment malfunctions and defective parts.

The operator should always signal a turning movement or a lane change.

When it is necessary to stop a Department vehicle at locations where traffic does not normally stop, the employee shall give warning to following vehicles by flashing his brake lights and slowing down gradually.

Should disabled equipment, either State or privately owned, be parked on the pavement without proper protection, it is the duty of employees to protect traffic by placing fusees, reflectors or torches. In the case of privately-owned vehicles, the matter should then be referred to the nearest police agency, your district radio room or Station 1 in the central office as soon as possible (see [IDOT's Vehicle Operator's Manual](#) and refer to Departmental Order 11-1).

B. SAFE SURVEYING PRACTICES

Survey crews exposed to traffic hazards that cannot be addressed with existing traffic control plans should discuss with the District Traffic Control Supervisor for special traffic and road conditions.

Surveying and measurements in the vicinity of power lines should be made with clean, dry, non-conductive instruments and non-metallic cloth tapes.

In snake-infested areas, the survey crew should be familiar with the first-aid treatment of snake bites and during survey planning determine the nearest medical facility where antivenin is available.

Pressurized spray cans stored in the passenger compartment of a vehicle must be placed in a container out of direct sunlight.

C. ACCIDENT REPORTING

Accidents which involve Department personnel and/or equipment shall be reported on the proper forms within 24 hours after the occurrence.

Vehicle and personal accidents shall be reported to the proper authorities and appropriate IDOT personnel.

Personal injuries shall be reported to the appropriate IDOT personnel.

Failure to report vehicle or personal injury accidents to his/her supervisor may disqualify an employee from receiving Worker's Compensation Benefits.

The operator of a vehicle or mobile equipment operated at Department expense, having been involved in an accident, shall immediately notify the nearest local police, sheriff department or state police and within one working day submit the necessary reports to the office to which the worker is assigned.

Incidents involving loss or damage to State equipment resulting from explosives, fire, theft, vandalism, and storm shall be reported immediately to the Director, District Engineer, or Bureau Chief.

IV. FIELD ACTIVITIES

A. PROPER HANDLING AND CARE OF HAND TOOLS

When working with chisels, star drills, and/or wedges, the following shall be observed:

- Maintain a sharp cutting edge.
- Striking surface should not be mushroomed or have overhang (dress or replace).
- Use only tools that are free of cracks or checks.
- All employees required to face the work shall wear eye protection.
- Wood chisels shall have a tight handle and sharp cutting edge.

Handles, sockets, and rivets of all shovels shall be smooth and securely fastened. Shovels shall never be used in place of a lever or pry bar.

Tools shall be used only for their intended purpose. Faulty, damaged, or broken tools shall be kept separately until repaired or properly disposed of in accordance with Department policy.

Axes, hammers, picks, and sledges shall have tight and securely wedged smooth straight-grained handles. All such tools with battered, mushroomed, or cracked striking faces or taped handles shall not be used.

Power tools shall not be left running while unattended.

Proper spacing of workers shall be maintained at all times.

Do not operate any equipment until all protective guards are in place and functioning properly.

Eye protection and other personal protection equipment is to be worn while clearing the sight line through vegetation.

B. CONFINED SPACES

See [Appendix D](#) of this Manual for the CONFINED SPACE POLICY.

C. PERSONAL PROTECTION

All employees engaged in ground-level field activities on or within 15 feet of a pavement open to traffic shall wear high-visibility (orange or strong yellow-green) vests or approved high-visibility outer garments. Flaggers and survey personnel who are working on the pavement shall wear high-visibility hats and vests at all times.

All employees are required to wear hard hats/caps or a high-visibility orange cap when engaged in field activities within 15 feet of a pavement open to traffic, when not in vehicles, or self-propelled mobile equipment.

Hard Hats/Caps: All supervisors are mandated to wear, and require their employees to wear, protective hard hats/caps when they are in an area where there is a potential for injury from falling, moving, swinging, or flying objects. Some work areas where hard hats/caps must be worn include the following:

- When under equipment or structures.
- When around loose materials.
- When around a boom truck, crane, telescoping boom, end loader, backhoe, coring, or drilling rigs or other equipment.
- When around tree trimming and removal operations.
- When around breaking or drilling pavement operations.
- When installing or repairing traffic signs, signals, and posts.
- When in areas where there is a chance of being struck by flying objects.

Note: This list is not intended to be all-inclusive; if there is any doubt, wear a hard hat/cap.

High-visibility Soft Headgear: High-visibility (orange or strong yellow-green) soft headgear is to be worn by employees when they are engaged in continuous activities located within 15 feet of a pavement of active highway construction work and when not covered in the hard hat/cap requirements.

Some work areas where high-visibility soft headgear should be worn include the following:

- When performing field reviews for planning and design functions.
- When working as a flagger.
- When working on survey crews.
- When performing pavement condition surveys.

Note: This list is not intended to be all-inclusive.

Eye protection shall be worn by surveying crews when working in vegetation or brush more than waist high.

Employees working in areas of dense vegetation should avail themselves of insect repellent.

D. WATER OPERATIONS

When two or more employees are working on or out of watercraft, a U.S. Coast Guard-approved personal floatation device shall be readily available for each person on board.

If an employee is working alone on or out of watercraft, or if an employee aboard a watercraft cannot swim, a U.S. Coast Guard-approved personal floatation device shall be worn at all times while on board.

A U.S. Coast Guard-approved floatation throwing device shall be readily available where the possibility of drowning exists during waterway operations when employees are working on, over or within 5 feet of the rivers, lakes, streams, or other watercourses of the state, regardless of the presence of other structural protection devices between the employee and the water.

If an employee is working alone on waterway operations where the possibility of drowning exists, or if an employee working on such operations cannot swim and there is no structural protection device between the employee and the water, a U.S. Coast Guard-approved personal floatation device shall be worn.

E. TRUCK USE AND HANDLING

Personnel riding on the outside of equipment is prohibited except where provision is made for the operator or others while performing an operation for which the equipment is designed.

Do not mount or dismount moving vehicles or equipment. To prevent backing accidents:

- Select parking locations to eliminate backing maneuvers.
- Avoid long backing movements.

Operators shall not operate vehicles or mobile equipment in reverse unless they are certain the backing movement can be made safely. When vision to the rear is limited and a fellow employee is available, that employee shall be utilized by the operator to assist with the backing movement. The person assisting the operator shall take a position outside the vehicle so as not to be exposed to oncoming traffic, or the backing vehicle. If help is not available, the operator shall go to the rear of the vehicle and visually check the area behind the vehicle before operating the vehicle in a backward movement.

When traveling in traffic, do not operate the vehicle at such a slow rate of speed as to cause an accumulation of other vehicles behind. If a slow rate of speed is unavoidable, occasionally pull off the road and wait in order that traffic may clear.

Do not stand on or within two feet of an open traffic lane to talk with the driver of a vehicle parked on the road shoulder.

A truck may be operated with the end-gate or liftgate in the open or horizontal position only when necessary for load or work situations.

When stopped or parked on the shoulder, as much clearance as possible shall be maintained between the edge of the pavement and the near side of the vehicle. The strobe light shall be used.

All vehicles, equipment, workers (except flaggers), and their activities are restricted at all times to one side of the pavement unless otherwise authorized. Avoid stopping on the shoulder across the roadway from another vehicle and/or operation.

Fusees are effective for emergency warning at accident scenes and other hazardous locations. Those who do use fusees must be aware of the following:

- Fusees have a limited burning time; therefore, if an emergency exists beyond the burning time of the fusees, additional fusees must be set or other warning devices such as emergency reflectors shall be used.
- The molten sulfur from a burning fusee can burn through a heavy leather shoe; therefore, extreme care must be taken when handling a lit fusee.
- To minimize the possibility of fire and /or explosion, never place lit fusees near the vehicles at an accident scene.

Strobe warning lights on vehicles so equipped must be used during the following operations:

- When performing slow-moving operations.
- When temporarily stopped on roadway surface or shoulder.
- During an emergency operation.

Select parking locations for Department vehicles and equipment that will not hide traffic signs and signals.

All trucks shall have the proper lights and reflectors, in accordance with ICC Regulations and Department Policy.

All trucks shall have the proper emergency warning kits, in addition to four fusees, which must be maintained in a serviceable condition for emergency use.

V. TEMPORARY TRAFFIC CONTROL

Definition: Temporary traffic control for surveys consists of using portable warning/control devices for a short period of time to provide safe working conditions for the surveyors and the motoring public. The time period has a duration of one work shift or less. Whenever possible, work should be conducted without any intrusion into a travel lane or within 2 feet of a travel lane. For work on shoulders that must intrude upon the above area, signs, protective vehicles, and/or flaggers may be required.

A. GENERAL

Traffic control and work site protection measures for contracted work, permit work, or utility work must be in accordance with the contract documents, permit documents, or the applicable IDOT Highway Standards for Traffic Control. Additional devices should be added when necessary to enhance safety. The proper use and most effective placement of traffic control devices are required to prevent injury to employees and the public.

For approved traffic control devices, refer to the IDOT website, Contract documents, Work Zone cases, or Permit documents.

Safety: The protection of employees and the public shall be the primary consideration when temporary traffic control measures are used. Workers should not be farther than 200 feet downstream of the protective vehicle or work vehicle.

Interference with Traffic: All reasonable measures shall be used to preclude interference with vehicular movement. Lane closures and roadbed closures shall not be considered until all other alternatives have been exhausted.

When to Use: Temporary control measures shall be used whenever surveyors work on or within 15 feet of the pavement edge.

Duration of Control Usage: Temporary control devices shall not be in place and functional any longer than necessary.

Purpose: Temporary traffic controls are used to establish a “working area-of-protection” for employees.

Peak Hours: On heavily traveled roads, surveys should be scheduled only during off-peak hours.

Offset Procedures: Offset surveying procedures should be used whenever appropriate. Actual time on the traveled portion of the roadway should be kept to a minimum.

Flagger Assistance: A crew member who is sighting or reading the instrument, or performing other operations on the pavement, should be assisted by a flagger or other crew member so he may be promptly warned of approaching traffic. Contractors or their authorized agents must follow Illinois Law with regard to flaggers ([430 ILCS 105/2](#)).

Lane Changes/Stops: If traffic is required to change lanes or stop, a flagger will be required. Attempts to direct traffic should only be done by a flagger, with flagger warning signs in place.

Sign Usage: Signs shall be used at all times when working on or within two feet of the pavement edge for a period of time in excess of 15 minutes.

High-Visibility Vest: All crew members on pavement or within 15 feet of the pavement edge shall wear high-visibility (orange or strong yellow-green) vests.

Any unattended equipment, such as a theodolite or tripod-supported range pole on the pavement centerline, shall be protected by cones as shown on the sketch below.

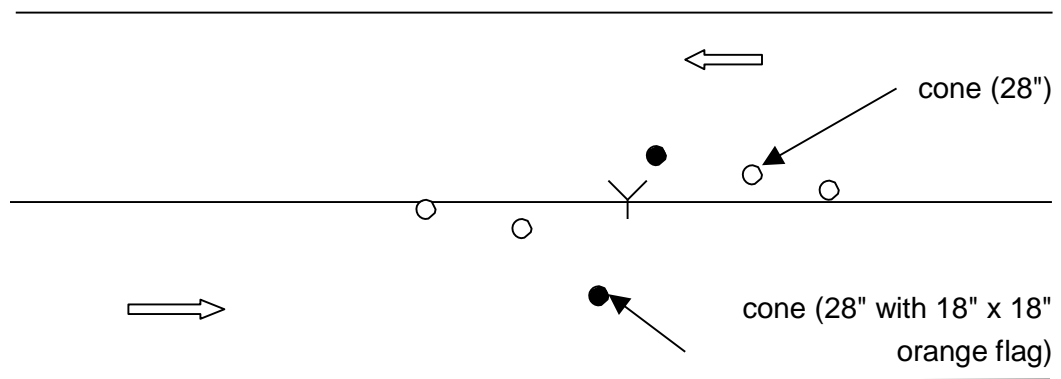

Night work or work on city streets with high volumes of traffic requires special protection. Law enforcement agencies should be contacted for assistance when the need is apparent.

B. INDIVIDUAL SAFETY

The safety of a surveyor often rests on that employee's own shoulders. Whenever feasible, each employee must obey the basic rule of facing traffic at all times. However, when working around traffic this is not always possible for surveyors.

If a surveyor cannot work facing traffic, the procedure should be changed or the order of work revised. If this cannot be done, then the exposed employee should be provided with a "lookout" who will serve as eyes for the vulnerable surveyor.

C. SHORT TERM ENCROACHMENTS ON PAVEMENT WITH ADEQUATE SITE DISTANCE

Short term encroachments on the pavement may be performed without a flagger, provided all vehicles are completely off the traveled lanes and as far off the edge of the pavement as practical, and the following conditions are met:

- Each task must be performed with extreme care.
- The amount of time the surveyor is on the pavement shall be minimized.
- The surveyor shall enter onto the pavement only during appropriate gaps in the traffic.
- When possible, work on the same side of the road as the vehicle.
- The surveyor shall wear a high-visibility vest (orange or strong yellow-green) or approved high-visibility outerwear and hat.

- The survey vehicle shall have its strobe light on.
- On multi-lane roadways, drive on the shoulder at slow speeds with strobe lights on.

If the surveyor must remain in the traffic lane and appropriate gaps do not exist, the lane must be closed with proper traffic control signs and devices. This provision does not apply when the survey crew works with an instrument on the pavement.

D. WORKSITE PROTECTION

D.1 Advanced Warning Signs

Warning signs shall be used whenever it is necessary for survey personnel to cross or enter a traveled lane unless entry into the travel lane is a short term encroachment. They are diamond-shaped panels with the words SURVEY CREW in black letters on a fluorescent orange reflective background. All warning signs and devices should be placed in accordance with Part 6 of the "[Manual on Uniform Traffic Control Devices for Streets and Highways.](#)"

Standard warning signs reading "SURVEY CREW" should be placed before work starts. They shall be a minimum of 48 inches by 48 inches. They should be placed approximately 1500 feet in advance of the work area in a position where they are readily visible to approaching traffic. If a series of advance warning signs are needed, they should be placed approximately 500 feet from the point of restriction with additional signs at 500-foot intervals.

On rural highways the signs should be placed on the shoulder from 2 feet to 10 feet outside the traveled lane. On urban streets the sign should be placed at least 2 feet behind the back of the curb and be readily visible by the motorist. In the case of divided highways, supplementary signs should be placed on the median for observation by motorists in the inner lane. In all cases, signs mounted on portable stands shall be no less than 12 inches above the travel way.

When two-way traffic is involved, signs should be provided for traffic from both directions.

To be effective, the signs should be placed not closer to the survey area than 500 feet for traffic speeds up to 45 miles per hour and 800 feet for traffic speeds of 45 miles per hour or more. If signs are placed too far in advance, their warning value may be lost. When surveying in rural locations, the signs should be moved ahead when the survey work area moves the length of ½-day's planned operation. When the survey area extends over a distance of ½ mile or more, additional warning signs or the use of cones may be needed.

Work within 15 feet of a lane open to traffic that exceeds 15 minutes shall include warning signs.

It is the responsibility of the employee in charge to ensure that a high-visibility orange flag is displayed on all single warning signs and on at least the first of a series of warning signs.

For the protection of the working crew and traveling public do not use signs that are so badly defaced that the legibility is affected. Poorly maintained signs are ineffective and may contribute to accidents. Request new signs as needed.

D.2 Traffic Cones

Each survey crew should have at least eight 28" cones. They should be used in addition to the advance warning signs. They should be arranged to define the survey area and safely divert traffic around the work zone. Tapers should be 10:1 or flatter and should be closely spaced to prevent traffic from entering the survey work area.

D.3 Flaggers

Surveyors working on pavements open to traffic require constant vigilance. Within each survey crew, at least one member should be trained as a flagger. It is preferable for all members to have received flagger training.

Flaggers must be courteous to all motorists. Be courteous even to those that want to argue and those who will not obey signs and devices. A flagger should be capable of favorably impressing the public and gaining its cooperation. The flagger shall:

- Be stationed at least 100 feet from the work site and workers at a location affording good visibility and should stand at the side of the lane where the traffic is to stop.
- Be stationed so they can be seen at least 500 feet by oncoming traffic.
- Hold the octagon-shaped STOP/SLOW paddle in an upright position with the STOP side facing the lane of traffic to be stopped.
- Hold the octagon-shaped STOP/SLOW paddle with the SLOW side facing the lane of traffic when the traffic is to proceed through the survey area at a slow rate of speed. Traffic control at multilane closures, urban areas, and other operations that require special consideration is to be established in accordance with the Department's "[Flagger Handbook](#)."
- Be stationed away from the survey equipment on the shoulder of the road facing approaching traffic in the lane "CLOSED" due to the survey activity. The flagger should not attempt to stop traffic by standing on the pavement unless standing inside a coned or barricaded area. On a two-lane highway, vehicles approaching in the "CLOSED" lane are required to yield to traffic in the "OPEN" lane unless opposing traffic has been stopped by another flagger. When opposing traffic is observed and closed lane vehicles are stopped, move to a conspicuous position near the centerline so as to be readily seen by approaching drivers. Check the "OPEN" traffic lane (or with the other flagger) to determine traffic conditions. Never turn your back to traffic approaching in the lane under your control. Once an opposing vehicle has passed and you have determined the way to be clear, move toward the shoulder, turn your sign to "SLOW", and motion stopped vehicles to proceed. As a flagger you have a responsibility for the safe passage of traffic at work areas. Your judgement must be keen and alert at all times, ready to warn traffic and crew of any danger.
- Be stationed at effective locations other than the open traffic lane.
- Always be alert for oncoming traffic and not turn their back on traffic in the lane under control.
- Be replaced at appropriate intervals to avoid fatigue.

It shall be the duty of the flagger to warn the workers of danger, should the driver of a vehicle fail to heed the flagger's signals.

Work conducted within the travel lanes of a highway or street that requires motorists to change lanes or stop shall be conducted with one or more flaggers.

Special situations, such as hills, curves, and bridges may warrant multiple flaggers and portable radios as directed by the Supervisor.

Flaggers shall be equipped with and required to wear or use the following:

- High-visibility vests and headgear (reflectorized for night work).
- Safety glasses.
- Flagger traffic control signs (STOP/SLOW paddle).
- For night operations, a red lantern or flashlight with a red wand shall be used. (Note: The flagger station shall be illuminated.)

When a motorist refuses to obey instructions, record the vehicle's license plate number, and time of day. Report the incident and its particulars to your immediate Supervisor.

D.4 Lookouts

The safety of IDOT surveyors is often jeopardized by moving vehicles or equipment. At times the duties of the personnel or other conditions preclude employees looking out adequately for themselves. In such cases, lookouts are to be used. Survey work shall not begin until required lookouts are in place.

Definition: A lookout is an employee whose sole duty is to provide immediate warning to co-workers of vehicles or equipment which have become imminent hazards to their safety.

All employees should school themselves to act as intermittent lookouts whenever their primary tasks afford "open spaces" for doing so. Flaggers should be equipped and prepared to function as lookouts whenever motorists fail to heed directions given.

The need for lookouts can be dictated by one or more factors for a given survey, a given survey operation or a particular situation. Common factors which influence usage of lookouts are:

- Location of instrument set-ups.
- Type of highway.
- Vertical alignment.
- Horizontal alignment.
- Traffic volume.
- Prevailing speeds.

- Type of survey.
- Traffic controls used.
- Construction activity.
- Proximity to actively used railroad tracks.
- Vegetation, relief roadway geometrics, and other conditions which restrict sight distance.

E. EQUIPMENT

Safety devices to use for temporary traffic control are:

Signs: These include those supported on temporary sign supports, on vehicles or the hand-held “SLOW/STOP” paddles. Each survey crew should have two 48-inch “Survey Crew” signs.

Warning flags: At least one “Flagman Ahead” sign should be carried in a survey vehicle.

Traffic cones: Each crew should have at least eight 28" cones.

Personal Safety Equipment: Each crew member should have a hard hat and safety vest.

Survey Vehicles: Survey trucks should have a top-mounted rotating/flashing amber light and mounted strobe lights.

F. PLACEMENT OF SIGNS AND CONES AND FLAGGERS

For the detailed drawings of the proper placement of signs, cones, and flaggers for particular situations when working on or near the pavement, see the October, 2010, Issue #9 or later version of the supplement to the Work Site Protection Manual published by the Department. Diagrams for various situations are provided in the booklet. Every survey vehicle should have one or more copies of the Work Site Protection Manual.

G. REMOVAL OF CONTROL DEVICES

All traffic control devices should be placed in the order that drivers will see them. Removal should be done in reverse order. Immediately remove devices and signs when protection is no longer needed.

During prolonged work breaks (such as lunch), do one of the following: remove devices, cover their messages, fold fabric signs, or turn them away from traffic. If signs are left up when workers are not visible, drivers tend to consider signing as meaningless and unwarranted and begin to ignore the warnings. Note: do not take breaks during any lane closures unless sufficient personnel are available to allow staggered individual breaks.

H. CLOSURES

Occasionally a survey will require a shoulder closure on a freeway or expressway in a high-volume, urban area or a stationary lane closure on a freeway or expressway.

Shoulder closure: Surveys along shoulders of freeways, expressways, and conventional roads require as much safety consideration as when surveying on the traveled way of these facilities.

The responsibility for the decision to close a shoulder for a survey should be made by the Chief of Surveys.

Shoulder closures shall be considered in the following situations:

- Parking on Shoulder – When a vehicle must be parked on a shoulder within 6 feet of traffic for more than 30 minutes, close the shoulder if an impact of the survey vehicle by an adverse vehicle might result in injury to crew personnel. When you park a vehicle on a shoulder, a taper of three or more cones should be set behind the vehicle.
- Surveying on the Shoulder – Close the shoulder when a survey must be on or along the shoulder and the survey itself will take longer than the time required for control set-up and retrieval. A shoulder closure shall be carefully considered when surveyors must work within 6 feet of traffic.

Surveys that require shoulder closures should be performed only during full daylight hours, and preferably during off-peak hours.

The Chief of Surveys shall decide if survey personnel are to make a particular closure. Shoulder closures on high-volume urban freeways and expressways shall be made only by the Bureau of Operations, unless the closure is short and survey personnel are trained and equipped to set the closure.

I. STATIONARY LANE CLOSURES

Today's surveying equipment and techniques usually make lane closures unnecessary. Use these guidelines if closures are considered.

A lane closure needs to be approved by the Chief of Surveys.

If possible only "take" the required free space needed to perform the survey, but do not reduce the lane's width to less than 10 feet between the cones and the edge of the adjacent lane.

Surveys that require lane closures should be performed in full daylight and during off-peak hours.

On freeways and expressways lane closures shall be made only by the Bureau of Operations.

For typical sign and cone installation for lane closures, space cones at 25-foot intervals at any stationary work site, such as an instrument set-up, to round off the traffic channel and to clearly define the work area.

J. CENTERLINE SURVEYS

Occasionally surveyors must establish and station the centerline of a conventional road. Often the centerline is established for use as a base line for gathering engineering and lane survey data or for construction staking.

For safety reasons, centerline surveys shall not be considered until all logical alternatives have been rejected. A centerline survey can be necessitated by one or more of these factors:

Roadbed geometrics: Roadbed geometrics which may preclude establishment of an offset line are:

- Steep cut and fill slopes.
- Narrow shoulders.
- Alignment.

Topography: Natural impediments such as boulders, brush, and trees may preclude establishment of an offset line.

Type of survey: The type of survey may preclude the establishment of an offset line.

Land Surveys: May need to establish the centerline for determining property ties and staking right-of-way.

Engineering Surveys: The stationing of the centerline can be required for engineering planning, studies, and design of:

- Truck passing lanes.
- Channelization.
- Alignment correction; horizontal, and vertical.
- Pavement rehabilitation.
- Left turn lanes.

A lane closure is considered as the ultimate inconvenience for motorists. Therefore, it might be the least desirable action necessary to enable a centerline survey. Closures are to be made upon the recommendation of the Chief of Surveys.

Every reasonable effort will be made to mitigate adverse effects on the flow of traffic. Such efforts will include scheduling work at optimum times.

K. STROBE WARNING LIGHTS AND EMERGENCY FLASHING LIGHTS

K.1 General

Strobe Warning Lights: Strobe lights are installed by IDOT as supplements to the manufacturer's standard equipment. Whenever vehicles are located on or within 15 feet of the pavement edge, mounted strobe lights shall be utilized. This includes all vehicles parked on the shoulder.

Emergency Flashing Lights: Factory-installed flashing lights which are included as standard equipment by the manufacturer on all cars, vans, and pickups and most other highway vehicles.

Vehicle Code: Illinois Vehicle Code allows vehicles used by highway authorities to display amber warning lights when such vehicles are parked or working on the highway.

Basic Policy: Strobe warning lights shall be used only to protect employees and equipment or to alert the public of a potentially hazardous highway condition.

Responsibility: Within the framework of the policy and the guidelines in this Section, each Chief of Surveys shall:

- Determine and approve the surveying vehicles to be equipped with strobe warning lights.
- Ensure that all operators of such vehicles know of this policy and these guidelines and comply with them.

Requesting and Installation: Strobe warning lights may be acquired through your District Office or Central Bureau and installed by the highway garage.

K.2 Guidelines for Use

These instructions are not intended to cover all possible criteria for using strobe warning lights or emergency flashing lights. Field personnel have the leeway to use good judgement for their own protection, as well as that of the public.

K.2.1 Daytime Use

Strobe warning lights shall be used:

- When a vehicle is parked in the median without any lane closure. This should be for short periods only.
- When a vehicle is parked on the right shoulder and work is being performed in the immediate vicinity of the vehicle. In this case, "immediate vicinity" means in such a location as to expose the worker(s) to traffic. Under certain conditions it might be necessary to establish a shoulder closure.

- When a vehicle is slowing in preparation to move onto the shoulder, into the median, or into a lane closure. Or, it is accelerating to move from the shoulder, median, or lane closure into traffic.
- When other highway conditions exist which, in the operator's opinion, warrant use of amber warning lights to protect workers and/or the public.

Emergency flashing lights shall be used:

- When the vehicle is parked on the right shoulder during periods of restricted visibility; for example, at night or when it is foggy.
- When the vehicle is parked within an established lane closure.
- When the vehicle is moving within an established lane closure.

K.2.2 Nighttime Use

Surveyors seldom work at night. However, survey personnel might be required to work at night on certain occasions. Those employees should be aware of these guidelines.

Amber strobe warning lights shall be used:

- While driving in a closed lane.
- While temporarily parked in a closed lane.

Emergency flashing lights shall be used:

- While driving in a closed lane.
- While temporarily parked in a closed lane.

When not to Use Amber Strobe Warning Lights:

- When exposure to accident to the employee or to motorists does not exist.
- When the vehicle is traveling at normal highway speeds.
- As a substitute for flashing arrow signs.
- As a substitute for moving the vehicle to a safe position where use of amber warning lights would not be required.

K.2.3 Additional Considerations

Shielding Lights: At times, amber warning lights are needed only on one side of a divided highway with the median barrier. Consider shielding the amber warning lights to prevent them from distracting or confusing motorists on the other side of the median barrier.

Passing on Shoulders: In emergencies, it might be necessary to travel on the shoulder to bypass traffic. In this case, use all three lights: headlights, emergency flashing lights, and amber warning lights. This procedure shall be a “last resort” operation for surveyors.

Used with other Devices: Where appropriate, coordinate the use of warning lights with other safety equipment and techniques. Do this for the broadest possible protection of employees and the public. See other topics in this section for guidelines.

Proper Usage: Be discriminatory in the use of amber warning lights. Improper usage could be hazardous to employees or the public, and thus be self-defeating. In addition, unnecessary usage might result in the public ignoring the device when it is needed.

VI. REFERENCES

[EMPLOYEE SAFETY CODE by the Illinois Department of Transportation](#)

FLAGGERS' HANDBOOK by the Illinois Department of Transportation.

WORK SITE PROTECTION MANUAL, ISSUE #9 by the Illinois Department of Transportation.

SURVEY MANUAL by the Ohio Department of Transportation, dated May 1995.

APPENDIX A
CURVE INFORMATION

BUREAU OF DESIGN AND ENVIRONMENT
SURVEY MANUAL

May 2015

APPENDIX A
CURVE INFORMATION

Table of Contents

	Page
Calculations for a Horizontal Circular Curve.....	A-2
Calculate P.C. and P.T. Stations.....	A-3
Calculate Deflection Angles	A-3
Calculate Chord Lengths	A-4
Calculate the Deflection for the First Station from the P.C. or any Odd Station Along the Curve	A-4
Example of a Field Book Setup for a Horizontal Curve	A-5
Calculations for Vertical Curve	A-5
Alternate Method of Calculating Curve Elevations.....	A-7
FIGURES	
Formulas & Examples—Simple Circular Curve (Figure A.1)	A-9
Types of Curves (Figure A.2).....	A-10
Vertical Curve (Figure A.3).....	A-11

APPENDIX A

CURVE INFORMATION

The radius can be used to define a curve in lieu of the degree of curve definition to describe horizontal curves.

For projects designed or constructed in English units of measure the arc definition of degree of curve is primarily used. The arc definition is defined as the change of direction of the central angle per an arc length of 100 feet. The relationship between the degree of curve and the radius in feet is stated by the following equation:

$$R = \frac{5729.58}{D}$$

Some of the various definitions and relationships of a simple curve are illustrated in [Figure A.1, page A-9](#), and given as follows:

(Δ) = Deflection Angle

Tangent distance (T) = $R(\tan \Delta / 2)$

External distance (E) = $R(\sec \Delta / 2 - 1) = R(\text{Exsec } \Delta / 2) = T(\sin \Delta / 2) - M$

Middle Ordinate (M) = $R(1 - \cos \Delta / 2) = R(\text{Vers } \Delta / 2) = R - R(\cos \Delta / 2)$

Long Chord (L.C.) = $2R(\sin \Delta / 2) = 2T(\cos \Delta / 2)$

Length of Curve (L) = $\frac{\Delta(100)}{D} = \frac{\Delta 2\pi R}{360^\circ} = \frac{\Delta R}{57.2958}$

The deflection angle (Δ) is measured in decimal degrees. For English units D is measured in decimal degrees and R is in feet.

In addition to simple curves, compound curves, reverse curves, and vertical curves are also used in highway work.

Compound curves are a combination of two or more simple curves and their use should be avoided where a simple curve can be used. However, due either to right-of-way problems or topographic considerations, a compound curve may occasionally be necessary. The curve must not be compounded at a ratio greater than 2:1. If the adjacent curves differ by more than 2°-00', a transition curve should be used.

A reverse curve is a combination of two simple curves of opposite curvature with a common tangent. A tangent adequate in length to provide the superelevation transition required by the Design Policies should be provided between the curves. If the reverse curves do not contain any superelevations, a tangent between the curves is not required.

A "Broken-back" curve is a term used to denote two curves in the same direction separated by a short tangent or by a flat curve whose radius is greater than twice the radius of either of the two initial curves. This layout is particularly objectionable on highways and should be avoided by using one simple curve or a compound curve if necessary.

The curves described above are illustrated in [Figure A.2, page A-10](#).

In the past, there was a period when transition or spiral curves were extensively used in connection with pavement widening at curves. As the curves became flatter and the pavement wider, it became unnecessary to widen at curves in this manner. It remains, however, that vehicular paths entering and leaving circular curves follow a spiral curve. For this reason or for reasons of "fitting" an alignment into a problem area, transition curves may occasionally be used.

Vertical curves are used to transfer the smooth change from one slope to another along an alignment to account for the change in terrain. See [Figure A.3, page A-11](#) for a diagram of a vertical curve.

CALCULATIONS FOR A HORIZONTAL CIRCULAR CURVE

Given:

$$\text{P.I. Sta. } 107+67.90, \Delta = 11^{\circ} 00' 00'' \quad D = 2^{\circ} 30' 00''$$

Calculate the Radius

$$R = 5729.58/D$$

$$R = 5729.58/2^{\circ} 30' 00''$$

$$R = 2291.83'$$

Tangent Distance

$$T = R (\tan \Delta/2)$$

$$T = 2291.83 (\tan 11^{\circ} 00' 00''/2)$$

$$T = 220.68'$$

Length of Curve

$$L = 100 (\Delta/D)$$

$$L = 100 (11^{\circ} 00' 00''/ 2^{\circ} 30' 00'')$$

$$L = 440.00'$$

External Distance

$$E = T (\tan \Delta/4)$$

$$E = 220.68 (\tan 11^\circ 00' 00''/4)$$

$$E = 10.60'$$

CALCULATE P.C. AND P.T. STATIONS**P.C. Station:**

$$\text{P.C.} = \text{P.I. Station} - \text{Tangent Distance}$$

$$\text{P.C.} = 107+67.90 - 220.68$$

$$\text{P.C.} = 105+47.22$$

P.T. Station:

$$\text{P.C. Station} + \text{Length of Curve}$$

$$\text{P.T.} = 105+47.22 + 440.00$$

$$\text{P.T.} = 109+87.22$$

CALCULATE DEFLECTION ANGLES**Deflection for 100' of Arc:**

$$100' \text{ Arc} = D/2$$

$$100' \text{ Arc} = 2^\circ 30' 00''/2$$

$$100' \text{ Arc} = 1^\circ 15' 00''$$

Deflection for 50' of Arc:

$$50' \text{ Arc} = D/4$$

$$50' \text{ Arc} = 2^\circ 30' 00''/4$$

$$50' \text{ Arc} = 0^\circ 37' 30''$$

Deflection for 25' of Arc:

$$25' \text{ Arc} = D/8$$

$$25' \text{ Arc} = 2^\circ 30' 00''/8$$

$$25' \text{ Arc} = 0^\circ 18' 45''$$

Deflection for 1' of Arc:

$$1' \text{ Arc} = D/200$$

$$1' \text{ Arc} = 2^\circ 30' 00''/200$$

$$1' \text{ Arc} = 0^\circ 00' 45''$$

CALCULATE CHORD LENGTHS

Chord Length for 100' of Arc:

$$100' \text{ Arc} = (2) (R) (\text{Sin of Deflection Angle}) \qquad \text{Deflection Angle} = D/2$$

$$100' \text{ Arc} = (2) (2291.83) (\text{Sin } 1^\circ 15' 00'')$$

$$100' \text{ Arc} = 99.99'$$

Chord Length for 50' of Arc:

$$50' \text{ Arc} = (2) (R) (\text{Sin of Deflection Angle}) \qquad \text{Deflection Angle} = D/2$$

$$50' \text{ Arc} = (2) (291.83) (\text{Sin } 0^\circ 37' 30'')$$

$$50' \text{ Arc} = 50.00'$$

CALCULATE THE DEFLECTION FOR THE FIRST STATION FROM THE P.C. OR ANY ODD STATION ALONG THE CURVE

1. Take the distance from the last point with a known deflection to the station you are calculating.
2. Multiply this distance by the deflection of a 1' Arc ($D/200$), this will give you the deflection between these two points.

Example: Find the deflection angle for Sta. 108+55

$$(108+55 - 105+47.22) = 307.78'$$

$$307.78'(0^\circ 00' 45'') = (3^\circ 50' 50'') \text{ Note: Use decimal degrees for this calculation.}$$

EXAMPLE OF A FIELD BOOK SETUP FOR A HORIZONTAL CURVE

Deflections for Curve #1					
Sta.	Distance	Chord Distance	Deflection Angle	Total Deflection	
105+00					
+47.22	0	0	0	0	P.C.
+50	2.78'	2.78'	0° 02' 05"	0° 02' 05"	
106+00	50.0	50.00	0° 37' 30"	0° 39' 35"	
+50	50.0	50.00	0° 37' 30"	1° 17' 05"	
107+00	50.0	50.00	0° 37' 30"	1° 54' 35"	
+50	50.0	50.00	0° 37' 30"	2° 32' 05"	
108+00	50.0	50.00	0° 37' 30"	3° 09' 35"	
+50	50.0	50.00	0° 37' 30"	3° 47' 05"	
109+00	50.0	50.00	0° 37' 30"	4° 24' 35"	
+50	50.0	50.00	0° 37' 30"	5° 02' 05"	
+87.22	37.22	37.22	0° 27' 55"	5° 30' 00"	P.T.

Calculated by (Initials) (Date)
Checked by (Initials) (Date)

$\Delta = 11^\circ 00' 00''$ $D = 2^\circ 30' 00''$
P.C. Marked by P.K. Nail

<u>Deflection Angles</u>			<u>Chord Lengths</u>		
100' of Arc	= D/2	= 2° 30' 00"	100' of Arc	= (2) (R) (Sin of Deflection Angle)	
	= 1° 15' 00"			= (2) (2291.83) (Sin 1° 15' 00")	
50' of Arc	= D/4	= 2° 30' 00"/4		= 99.99'	
	= 0° 37' 30"		50' of Arc	= (2) (R) (Sin of Deflection Angle)	
1' of Arc	= D/200	= 2° 30' 00"/200		= (2) (2291.83) (Sin 0° 37' 00")	
	= 0° 00' 45"			= 50.00'	

P.T. (Note: Total Deflection should equal $\Delta / 2$)

CALCULATIONS FOR VERTICAL CURVE

Please refer to [Figure A.3 on page A-11](#) of this Appendix for a graphic view of the components of a vertical curve. Following are several definitions of the elements of a vertical curve and a set of sample field notes that have been prepared for field use to stake out a vertical curve.

Definitions:

PVC: "Point of vertical curve." Station on centerline where the vertical curve starts. PVI:

"Point of vertical intersection". Station at which the two tangent grade lines intersect.

PVT: "Point of vertical tangency". Station on centerline where the vertical curve ends.

LVC: "Length of vertical curve."

OFFSET: The vertical distance from the tangent grade line to the vertical curve.

e: a mathematical constant whose value is determined by the grades of the two intersecting tangents and the length of the vertical curve.

$e = \text{Grade \#2 (\%)} - \text{Grade \#1 (\%)} \times (\text{LVC}) (\text{Stations}) / 8 (\text{Constant}) =$
 $(G_2 - G_1) (\text{LVC}/100) / 8$

CL ELEV: = Tangent Elevation + offset. Highpoint / Low point locations.

Distance from PVC: = $G_1 \times (\text{Stations}) / G_2 - G_1$

Sample set of field notes for a vertical curve.

<u>Station</u>	<u>(X) Distance</u>	<u>Tangent Elevation</u>	<u>(Y) offset</u>	<u>Elevation on Curve</u>
45+50		429.34		
46+00	50.00	428.84	0.03	428.87
47+00	150.00	427.84	0.26	428.10
48+00	250.00	426.84	0.71	427.55
49+00	350.00	425.84	1.40	427.24
49+50	400.00	425.34	1.83	427.17
50+00	450.00	424.84	2.31	427.15
50+50	500.00	424.34	2.86	427.20
51+00	550.00	423.84	3.46	427.30
52+00	650.00	422.84	4.83	427.67
52+50	700.00	422.34	5.60	427.94
53+00	650.00	423.44	4.83	428.27
54+00	550.00	425.64	3.46	429.10
55+00	450.00	427.84	2.31	430.15
56+00	350.00	430.04	1.40	431.44
57+00	250.00	432.24	0.71	432.95
58+00	150.00	434.44	0.26	434.70
59+00	50.00	436.64	0.03	436.67
59+50		437.74		437.74

$e = (G_2 - G_1) \text{LVC} / 8 = (2.2 - (-1.0))14/8 = 3.2(14)/8 = 5.60$ Vertical offset at VPI.

Y-Offset @ 46+00 & 59+00 = $(50/700)^2(5.60) = 0.03$

47+00 & 58+00 = $(150/700)^2(5.60) = 0.26$

48+00 & 57+00 = $(250/700)^2(5.60) = 0.71$ $Y = e (X/L)^2$

49+00 & 56+00 = $(350/700)^2(5.60) = 1.40$

49+50 = $(400/700)^2(5.60) = 1.83$

50+00 & 55+00 = $(450/700)^2(5.60) = 2.31$

50+50 = $(500/700)^2(5.60) = 2.86$

51+00 & 54+00 = $(550/700)^2(5.60) = 3.46$

52+00 & 53+00 = $(650/700)^2(5.60) = 4.83$

52+50 = $(700/700)^2(5.60) = 5.60$

When using this method the elevation difference is calculated from both the tangent gradients at specified distances from the PVC and PVT and then applied to the tangent

elevations determined for the two gradients. The value of (e) is the offset at the VPI and each individual station's offset value is determined as a percentage of the external at the VPI. The vertical offsets from a tangent to a parabola are proportional to the squares of the distances from the point of tangency.

STATION AND ELEVATION OF LOW POINT OF VERTICAL CURVE

X (In Station from VPC) = $G1L / (G2-G1) = 1.0(14) / (2.2-(-1.0)) = 1.0(14) / 3.2 = 4.375$ Sta. or 437.50'

Station of Low Point = $45+50 + (4+37.5) = 49+87.50$

X-Distance = 437.50 Tangent Elev. = $429.34 - 437.50(0.01) = 424.96'$

Y-Offset $(437.50 / 700)^2 (5.60) = 2.19'$

Elevation of Low Point = $424.96 + 2.19 = 427.15'$

ALTERNATE METHOD OF CALCULATING CURVE ELEVATIONS

An alternative method of calculating the elevations of a vertical curve is as follows: calculate the value of (a) using the following formula: The tangent elevations are computed using the elevation of the PVC and the slope of the forward tangent. An elevation is computed for each station needed. Then compute the offsets from the forward tangent to the curve. The offset equals aX^2 . Apply the offset values to the tangent elevation to obtain the curve elevation.

$$a = 100(G_2 - G_1) / 2L = 100(2.2 - (-1.0)) / 2 * 1400 = 0.114$$

$$2a = 0.228$$

Station	Tangent El. = G_1X	Offsets from $AV=aX^2$	Curve. Elev.	Check 1 st Diff.	2 nd Diff.
45+50	429.34		429.34		
46+00	428.84	$-.114 * 0.50^2 = 0.03$	428.87		
47+00	427.84	$-.114 * 1.5^2 = 0.256$	428.10	-0.77	
48+00	426.84	$-.114 * 2.5^2 = 0.71$	427.55	-0.55	0.22
49+00	425.84	$-.114 * 3.5^2 = 1.40$	427.24	-0.31	0.24
49+50	425.34	$-.114 * 4.0^2 = 1.83$	427.17		
50+00	424.84	$-.114 * 4.5^2 = 2.31$	427.15	-0.09	0.22
50+50	424.34	$-.114 * 5.0^2 = 2.86$	427.20		
51+00	423.84	$-.114 * 5.5^2 = 3.46$	427.30	+0.15	0.24
52+00	422.84	$-.114 * 6.5^2 = 4.83$	427.67	+0.37	0.22
52+50	422.34	$-.114 * 7.0^2 = 5.60$	427.94		
53+00	421.84	$-.114 * 7.5^2 = 6.43$	428.27	+0.60	0.23
54+00	420.84	$-.114 * 8.5^2 = 8.26$	429.10	+0.83	0.23
55+00	419.84	$-.114 * 9.5^2 = 10.31$	430.15	+1.05	0.23
56+00	418.84	$-.114 * 10.5^2 = 12.60$	431.44	+1.29	0.24
57+00	417.84	$-.114 * 11.5^2 = 15.11$	432.95	+1.51	0.22
58+00	416.84	$-.114 * 12.5^2 = 17.86$	434.70	+1.75	0.24
59+00	415.84	$-.114 * 13.50^2 = 20.83$	436.67	+1.97	0.22
59+50	415.34	$-.114 * 14.00^2 = 22.40$	437.74		

One method of checking your calculations is to calculate the first and second differences of the curve elevation between the full stations. The second difference should be the same and is equal to $2a$, which is the percent of constant change in slope per station.

If other methods of calculating the station vertical offsets are desired, see a survey textbook for the procedures.

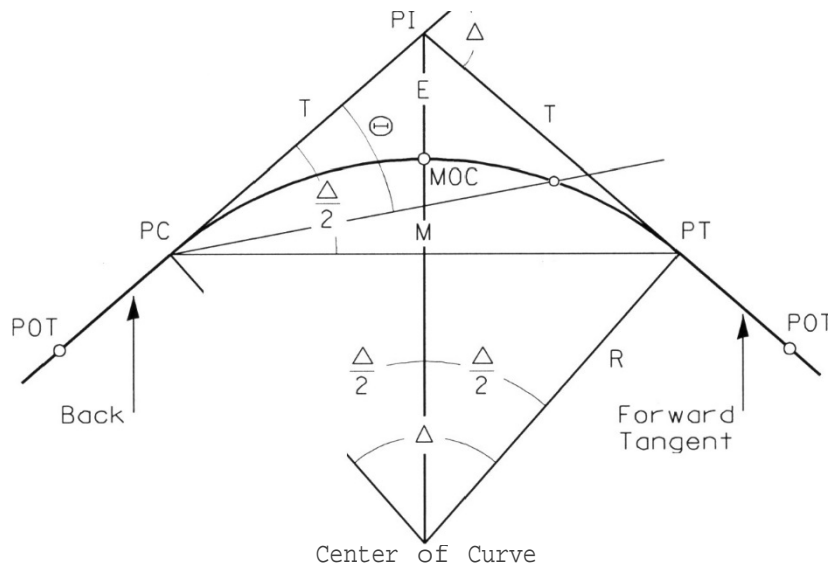
FORMULAS & EXAMPLES –SIMPLE CIRCULAR CURVE

DEFINITIONS Be sure the instrument and carrying case are kept dry. If they become wet, allow them to air dry before closing the carrying case. Extend level rod and let air dry overnight.

Back Tangent	= Tangent from which the curve starts
Forward Tangent	= Tangent on which the curve ends
P.O.T.	= "Point on Tangent"- Any point on the tangent portion where the curve starts or ends
P.C.	= "Point of Curvature" - Station on centerline where the curve starts
T	= "Tangent"- The distance on a straight line from the P.C. to the P.I. or the P.T. to the P.I.
MOC	= "Mid-Point of Curve"
P.T.	= "Point of Tangency"- Station on centerline where the curve ends
L	= "Length of Curve" - The distance <u>along the curved centerline</u> from the P.C. to the P.T.
P.I.	= "Point of Intersection"- The point where the back tangent and the forward tangent intersect
R	= "Radius of the Curve"
E	= "External Distance" - Distance from the MOC to the P.I.
M	= "Middle Ordinate" - Distance from the MOC to the mid-point of the straight line between the P.C. and the P.T. (the LC)
LC	= "Long Chord" - Straight line distance from the P.C. to the P.T.
Δ	= The Central Angle of the Curve - The angle between a radial line from the center of the curve to the P.C. and a radial line from the center of the curve to the P.T.; also equals the angle of intersection of the forward tangent with the back tangent

Figure A.1

TYPES OF CURVES

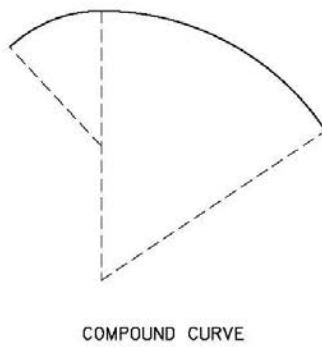
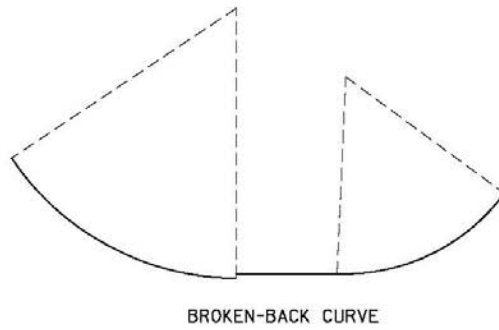
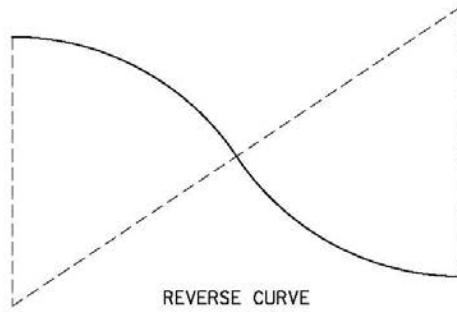
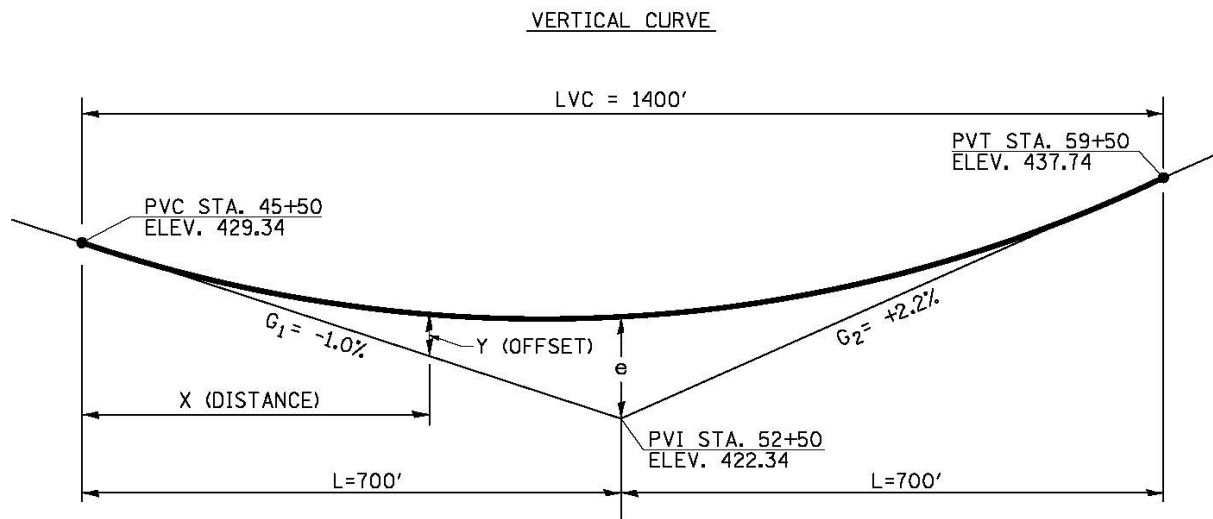

Figure A.2



DEFINITIONS:

PVC STA.: "POINT OF VERTICAL CURVE" - STATION ON CENTERLINE WHERE THE VERTICAL CURVE STARTS

PVI STA.: "POINT OF VERTICAL INTERSECTION" - STATION AT WHICH THE TWO TANGENT GRADE LINES INTERSECT

PVT STA.: "POINT OF VERTICAL TANGENCY" - STATION ON CENTERLINE WHERE THE VERTICAL CURVE ENDS

LVC = "LENGTH OF VERTICAL CURVE"

OFFSET = THE VERTICAL DISTANCE FROM THE TANGENT GRADE LINE TO THE VERTICAL CURVE

e = A MATHEMATICAL CONSTANT WHOSE VALUE IS DETERMINED BY THE GRADES OF THE TWO INTERSECTING TANGENTS AND THE LENGTH OF THE VERTICAL CURVE

$$e = \frac{\text{GRADE \#2 (\%)} - \text{GRADE \#1 (\%)} \times \text{LVC (STATIONS)}}{8 \text{ (CONSTANT)}}$$

CL ELEVATION = TANGENT ELEV. \pm OFFSET

HIGH POINT / LOW POINT LOCATION

DISTANCE FROM PVC = $G_1 \times \text{LVC (STATIONS)} / G_2 - G_1$

Figure A.3

APPENDIX B

ELECTRONIC SURVEY DATA
EXCHANGE FORMATS

BUREAU OF DESIGN AND ENVIRONMENT
SURVEY MANUAL

May 2015

APPENDIX B

ELECTRONIC SURVEY DATA EXCHANGE FORMATS

Table of Contents

	Page
I. INTRODUCTION	B-1
II. REFERENCE MANUALS	B-1
III. DELIVERABLES	B-1
A. Hard Copy Document	B-2
B. Electronic Copy	B-2
IV. DELIVERABLE DEFINITIONS	B-2
V. DATA MEDIA	B-5
VI. DATA FORMATS	B-5
VII. FUTURE DIRECTION	B-5

APPENDIX B

ELECTRONIC SURVEY DATA EXCHANGE FORMATS

I. INTRODUCTION

This policy delineates the responsibilities of the Illinois Department of Transportation (IDOT) and any firm providing route or land surveying services to the Department. It only covers the exchange of electronic media and the documents related to identifying and explaining the proper use of the electronic media for survey data.

The Department classifies its survey work into two types—route and land.

Route survey consists of measurements, calculations, and field work necessary to establish line and grade for a specific transportation improvement. Route survey also includes topographic surveys, cross sections, hydraulic surveys, and aerial surveys for highway and waterway projects.

Land surveys determine boundaries, writing descriptions of specific parcels of land and the installation and restoration of monuments.

II. REFERENCE MANUALS

1. [Design Manual](#)
2. [Survey Manual](#)
3. [Land Acquisition Policies and Procedures](#)
4. [CADD Roadway and Structure Project Deliverables Policy](#)

The first three references provide instruction on performing surveys for the Department. The CADD Roadway and Structure Project Deliverables Policy covers all requirements for project deliverables. This document is a live document that can be found online at www.idot.illinois.gov.

III. DELIVERABLES

During, or at the completion of, the Consultant's contract involving electronic surveying work, two deliverables will be required:

A. HARD COPY DOCUMENT

The paper document will be in a bound volume(s) to allow the Department to have a hard copy record (8-½" x 11") of the collected data. All paper documents provided to the Department must contain the Consultant's name.

The pages of the survey paper documents will be numbered or identified in such a way as to separate each section of the volume listed in the index. Included will be a list of file names, a description of each file on the mutually agreed upon digital media to be transmitted to the Department, the name of the software application package used, and the version number.

It must contain a title page, an index, instructions, the raw data, the observation file listing, the compiled reports, the location map, and appropriate sketches.

B. ELECTRONIC COPY

The mutually agreed upon digital media shall contain electronically collected and processed computer data files which, with the paper documents, provide the Department a complete and accurate survey contract. Included with the digital media will be a list of file names and a description of each file on the digital media transmitted to the Department. This information shall be provided in the "Readme.txt" file described below.

It must contain the raw data, the observation file, and the compiled reports.

IV. DELIVERABLE DEFINITIONS

1. Title Page – Contains such information as the consultant's name, route, section, county, survey crew name, date of beginning and completion dates, job number, etc.
2. Index of Documents/Files – The survey information to be provided to the Department by the consultant will include an index. The index is a Table of Contents used to describe and identify the sections of the transmitted survey data.

All digital media provided to the Department must contain the consultant's name, a list of the directory of the contents of the media, a description of the contents of each file, description of each file, description of the digital media format (density, means of creating the data file), the date the media was created, and project identification. Nonconforming media identification will not be accepted.

An example of the proper format is:

Project: _____
Limits: _____
Job Number: _____
Create Date: _____
Format: _____
Density: _____
Contents: _____

A completed example of the proper format is:

Project: IL 83
Limits: St. Charles to North
Job Number: P-91-001-93
Create Date: 3/12/14
Format: DOS Copy Command
Density: CD-R 700MB 52x
Contents: Readme.txt file

One file shall be named "Readme.txt." This file will contain a listing of the contents of each file on the disk. The listing of each content shall include the limits and type of data. Notes that do not fit elsewhere are to be entered here also.

3. Instructions – Include a copy of the contract scope of work for the survey and any specific directions given to the survey party on how to proceed with the survey.

4. Raw Data – The observations going into the data collector. Raw data from a digital level or electronic survey data collector for a total station or GNSS rover provides a historical record of the original survey data that was collected. After being transferred from the data collector, this data file will not be edited or changed.

The raw data file contains original data necessary for the survey including vertical and horizontal angles, dimensions, slope distances, IDOT point codes, point numbers, and material codes.

Typically, the raw data file is used to create an observation file which can be edited after the survey is performed. The observation file can be edited using the software for the total station collecting the data. A log file of any changes to the observation file must also be submitted.

5. Location Map – A portion of a county or city map which depicts the area covered by the survey. The purpose of this map is to show the general location of the survey work such that it can be readily located in the future. In the case of a hydraulic survey, it might be appropriate to use a quad map for the location map, and the flood plain sections could be shown thereon. A north arrow and the beginning and ending points are to be shown on the map. The map is to be accompanied by a written description of the termini of the survey work. Indicate the city or village in urban areas and sections, township, range and principal meridian, and county in rural areas.

6. Survey Sketches – Unscaled drawings, usually rendered by hand, which show topographic information to properly orient the survey data. Several different types of sketches may be required to ensure that further users of the survey data will understand and can duplicate the survey results and verify the locations of control points and visualize the spatial relationship of key points, significant fixed objects, and complex topographic features. All sketches must include a North arrow. If a sketch covers a congested area, please use point numbers with a corresponding table.

Sketches may include:

a) Level Circuit Bench Marks – Shows the approximate location and spatial orientation of the bench mark circuit. A written description of each bench mark and its location must accompany the sketch.

b) Control Survey – Shows the approximate location and spatial orientation of each survey used to provide coordinates (horizontal and/or vertical) of points to which supplementary surveys are adjusted. A written description of each control point and its location must accompany the sketch. This sketch provides a visual supplement to the raw data provided in [Item 4](#) above.

V. DATA MEDIA

The only media that will be accepted are CD or DVD.

VI. DATA FORMATS

All data files, except for the raw data, shall be in Microstation V8.x .dgn and Geopak .gpk files.

VII. FUTURE DIRECTION

The Department is moving toward the use of digital terrain models (DTMs) instead of the usual cross sectioning procedures. Once the use of DTMs is adopted, the above requirements will be revised to cover their usage. The Department's 2015-2020 plan discusses the move to full 3D CAD for all projects. Consultants should monitor the [Department's website](#) for changes in CAD and deliverable policies.

APPENDIX C

ILLINOIS STATE PLANE COORDINATES

BUREAU OF DESIGN AND ENVIRONMENT
SURVEY MANUAL

May 2015

APPENDIX C

ILLINOIS STATE PLANE COORDINATES

Table of Contents

	Page
I. INTRODUCTION.....	C-1
II. CONVERGENCE OF MERIDIANS.....	C-2
III. THE COORDINATE SYSTEM.....	C-3
IV. REDUCTION OF GROUND LENGTHS	C-4
V. PLANE AZIMUTH AND COORDINATES.....	C-5
VI. USING THE ILLINOIS STATE PLANE COORDINATE SYSTEM.....	C-8
VII. PROJECTIONS	C-8
A. Transverse Mercator	C-8
A.1 East Zone	C-9
A.2 West Zone	C-9
B. Lambert Conformal.....	C-10
VIII. DISTANCE REDUCTIONS	C-10
A. Elevation Factor for the North American Datum of 1927	C-10
B. Elevation Factor for the North American Datum of 1983	C-11
C. Scale Factor	C-12
D. Grid Factor	C-12
IX. HORIZONTAL ANGLES IN THE STATE PLANE COORDINATE SYSTEM.....	C-13
A. Horizontal Angle Correction.....	C-13
B. Convergence Angle.....	C-13
X. ORTHOMETRIC AND ELLIPSOIDAL HEIGHTS.....	C-14
A. Orthometric Heights.....	C-14
B. Ellipsoidal Heights.....	C-15
C. Geoid-Ellipsoid Separation.....	C-15
XI. COMPUTING SURVEY TRAVERSES USING STATE PLANE COORDINATES.....	C-15
A. Calculating Grid Azimuth	C-15
B. Calculating the Traverse.....	C-16

FIGURES

Characteristics of Convergence (Figure C.1).....	C-6
Convergence of Meridians (Figure C.2).....	C-6
Central Meridian (Figure C.3).....	C-7
Central Meridian, Grid North & True North (Figure C.4).....	C-7
State Plane Coordinate Zones (Figure C.5).....	C-17
Illinois State Plane Coordinate System Projection Constants (Figure C.6).....	C-18
Zones of the NAD83 State Plane Coordinate System (Figure C.7).....	C-19
Distance Reduction Geodetic to Grid (Figure C.8).....	C-20
Reduction to Sea Level (Figure C.9).....	C-21
Reduction to the Ellipsoid (Figure C.10).....	C-22
Transverse Mercator Projection, Illinois, East Zone (Figure C.11).....	C-23
Transverse Mercator Projection, Illinois, West Zone (Figure C.12).....	C-24
Geodetic and Grid Azimuth (Figure C.13).....	C-25
Geoid-Ellipsoid Surface Relationships (Figure C.14).....	C-26

APPENDIX C

ILLINOIS STATE PLANE COORDINATES

I. INTRODUCTION

The National Geodetic Survey (NGS) uses geodetic surveying procedures to compute all of its surveys. The results obtained from computing geodetic data are precise but require the use of complex spherical formulas and special tables. The complexity of these computations and the demand for being able to make use of this vast amount of information prompted the Federal Board of Surveys and Maps to recommend that its member organizations adopt the plane rectangular coordinate systems. Plane coordinate data is not exact since allowances must be made in the transfer of the survey data from the surface of the Earth (which is curved in latitude and longitude) to the plane surface of the grid system, which is curved in only one dimension. The computations are made with the ordinary formulas of trigonometry.

Two projections were selected for use in plane coordinate systems. The Lambert Projection was selected for use in States whose longitudinal axis is east-west and the Transverse Mercator Projection was selected for States whose longitudinal axis is north-south. The Illinois State Plane Coordinate System is based on the Transverse Mercator Projection.

The North American Datum of 1927 (NAD27) uses Clarke's spheroid of 1866 for its reference ellipsoid, which is a best fit for the United States. The North American Datum of 1983 (NAD83) uses the Geodetic Reference System (GRS80), an ellipsoid which best fits the overall shape of the entire Earth. The published values of latitude and longitude of the National Geodetic Survey horizontal control positions are referenced to these mathematical figures. The NAD83 values have replaced the NAD27.

Since the introduction of NAD83, NGS has performed various adjustments of the datum to incorporate the increased use of Global Navigation Satellite System (GNSS) technology and the advent of the Continuously Operating Reference System (CORS). The initial realization of NAD83 is now referred to as NAD83 (1986), based on the year it was initially published.

The most recent adjustment, the [National Adjustment of 2011](#), is referred to as NAD83 (2011) epoch 2010.0. It is a nationwide, geometric adjustment of passive stations with positions determined using GNSS technology, which includes the Global Positioning System (GPS).

The National Adjustment of 2011 resulted in new values for latitude, longitude, and ellipsoid height, but did not affect the orthometric heights of stations. However, a future nationwide vertical adjustment is being considered to determine GNSS-derived orthometric heights, based on the results of NA2011.

All National Geodetic Survey horizontal control monuments in Illinois reflect the new adjustment values. The latest adjusted values should always be used for new projects, unless directed not to do so by the project engineer. When planning new work on projects started under an older adjustment, consideration must be given to whether it is better to continue with the original project control. This decision must consider the amount of design work done based on the prior control and the impact that updating the control would have on this design work.

One of the primary uses of a State Plane Coordinate System is to make possible the correlation of surveys in all areas of the system. The positions of the grid lines of a state coordinate system are determined with respect to the meridians and parallels on the spheroid (ellipsoid) of reference. Therefore, a point that is defined by stating its latitude and longitude can also be defined by stating its X and Y coordinates on a grid.

If either set of values is known, the other set can be computed. This is true also with lengths and azimuths. The geodetic length and azimuth between two positions can be transformed into a grid length and azimuth or the inverse by mathematical computations. A computer program is available for determining the geodetic position from plane coordinates and vice versa.

II. CONVERGENCE OF MERIDIANS

The curvature of the Earth causes meridians of longitude to converge. Any two meridians intersect at the North Pole with an angular value equivalent to the difference between the values of the two meridians. This characteristic of convergence is demonstrated in [Figure C.1, page C-6](#) showing lines tangent to 88 degrees and 89 degrees longitude at the equator and again at the Pole.

The effect of this convergence, (θ), on the survey line is found by multiplying the difference in the longitude ($\Delta \lambda$) of the ends of the line by the sine of the mean latitude (Φ) of the line. For example: Calculate the convergence of the meridians between two points whose geographic coordinates are:

Latitude 45° 15' 15" 45° 10' 15"

Longitude 75° 13' 28" 75° 10' 12"

The mean latitude is 45° 12' 45"

The difference in longitude is 3' 16" = 196"

$\theta = \Delta \lambda \sin \Phi$

$\theta = (196) (.70972) = 139" = 0^\circ 2' 19"$

In geodetic surveying this convergence must be taken into consideration because of its effect on the azimuth of traverse and triangulation lines. The forward geodetic azimuth differs in numerical value from the back azimuth by a quantity other than 180°. This quantity is expressed by the equation $a = a' + 180 + \Delta \theta$; where a is the forward azimuth, a' is the back azimuth, and $\Delta \theta$ is the numerical difference. This can be seen in [Figure C.2, page C-6](#). Meridians are drawn through points A and B which in each case represents true north. Angles "a" and "b" are not equal because of the convergence, therefore, azimuth values at A and B are not equal by that amount.

III. THE COORDINATE SYSTEM

The Illinois coordinate system is made up of two zones, each having a central meridian. A central meridian is located at 88° 20' West Longitude for the East Zone and at 90° 10' West Longitude for the West Zone. The latitude of the origin of the zones is 36° 40'. These zones were created by making a cylinder secant to the spheroid (ellipsoid). The zones overlap a small amount to facilitate the transfer of data from one to the other. When the system was devised, the scale along the central meridian of the East Zone was made 1 part in 40,000 too small. Therefore, 28 miles east or west of this central meridian the scale is exact. The scale is too large. The scale along the central meridian of the West Zone was made one part beyond this distance in 17,000 too small. Therefore, in this case, the point of exact scale is reached at 43 miles east or west of the central meridian. [Figure C.3, page C-7](#) shows graphically the relationship between the plane coordinate system and the lines of latitude and longitude, where λ is the longitude of a point and Φ is the latitude of a point.

The X coordinate of each central meridian is assigned the value of 500,000 feet (NAD27). For the NAD83 the central meridians are assigned different values. The East Zone is 300,000 meters and the West Zone is 700,000 meters. The distance from the central meridian to any point east or west of it is called X'. $X' = X - 500,000$ or $X' = 500,000 - X$. This equation can be used for both the NAD27 and the NAD83 values to determine the scale factor. The projection parameters for Illinois did not change when the NAD83 values were established.

At the central meridian, grid north is the same as geodetic north. At all other points in the system, there is an angular difference between them. This angular difference is represented by $\Delta \alpha$. Its value is the product of the sine function of the latitude of the point and the seconds of longitude between the central meridian and the point ($\Delta \alpha = \Delta \lambda'' \sin \Phi$).

Figure C.4, page C-7 shows that west of the central meridian, grid north is west of true north and grid azimuths are numerically greater than geodetic azimuths. For positions east of the central meridian, the reverse is true. This representation also clearly points out how the delta-alpha angle should be applied to geodetic azimuths to obtain plane azimuths. It is apparent that the difference between grid azimuth values and geodetic azimuth values increases as work progresses east or west from the central meridian. In Illinois, the delta-alpha angle ($\Delta \alpha$) amounts to approximately one minute of arc per mile.

The National Geodetic Survey has prepared two publications that are useful in computing coordinates on the Illinois State Plane Coordinate System. Special Publication No. 303 "Plane Coordinates Projection Tables" illustrates a method and gives values to be used in transforming geodetic positions to plane coordinates and the inverse. Special Publication No. 235 "The State Coordinate System" is a manual designed to aid the surveyor in using the system.

IV. REDUCTION OF GROUND LENGTHS

A survey to be placed on the Illinois State Plane Coordinate System must have a sea level (elevation) correction and a scale correction applied to the ground measured distances.

The elevation factor to be applied to convert the ground distances to sea level distances is computed by the following equations. The elevation factor = $R / (R+h)$, where h is the elevation of the ground above sea level and R is the mean radius of curvature of the sea level spheroid across Illinois, which is 20,906,000 feet. This elevation factor is used for the NAD27. For the NAD83, the elevation factor is = $R / (R+N+H)$ where N is the geoid-ellipsoid separation, and H is the elevation above sea level.

In Illinois the value of N is always negative. It should be applied algebraically in the formula. The average elevation to be used can be obtained from USGS Quadrangles.

The factor to be applied to reduce the ground distance to the plane of the cylinder is found in the tables on pages 27, 28, and 29 in Special Publication No. 303. The X' value shown on these pages is that described above. The scale factor may be expressed as a ratio of grid length to geodetic length, or it may be given as a numerical correction to be applied to the measured length reduced to sea level. The scale difference, and therefore the scale factor, decreases with the distance from the central meridian. When traverse or triangulation lines exceed five miles in length, it becomes necessary to investigate the contributing elements and use judgment in applying the proper computations to establish a scale factor. There is no set formula that can be applied. For example, a traverse line running north-south near 352,160 E (East Zone) and 647,840 E (East Zone) would have no scale correction. The scale factor becomes unity near these grid lines. For survey lines that run predominantly east-west for some distance from 352,160 E and 647,840 E, the scale factor changes rapidly. For surveys with lines in excess of five miles in length and expected to have an accuracy of one part in 10,000 or better, the scale factor must be an average of that at each end and at the center of the survey. The equation:

$$\frac{1}{K} = \frac{1}{6} (1 / K_1 + 4 / K_3 + 1 / K_2)$$

produces this refinement. The terms K_1 and K_2 represent the scale factor for the end points of the line and K_3 the midpoint. In cases where elevation factors and scale factors both must be used, it is advisable to combine these factors for simplicity. This combined factor is normally referred to as the "grid factor".

V. PLANE AZIMUTHS AND COORDINATES

The azimuth of a line is its direction and is expressed as the clockwise angle between grid north and the line. Grid north is assigned a value of zero degrees. The advantage in using azimuths in place of bearings is that the observed angle between two lines can be applied directly to the azimuth of one line to obtain the azimuth of the other. In plane surveying, the azimuth and back azimuth of any line differ by 180°.

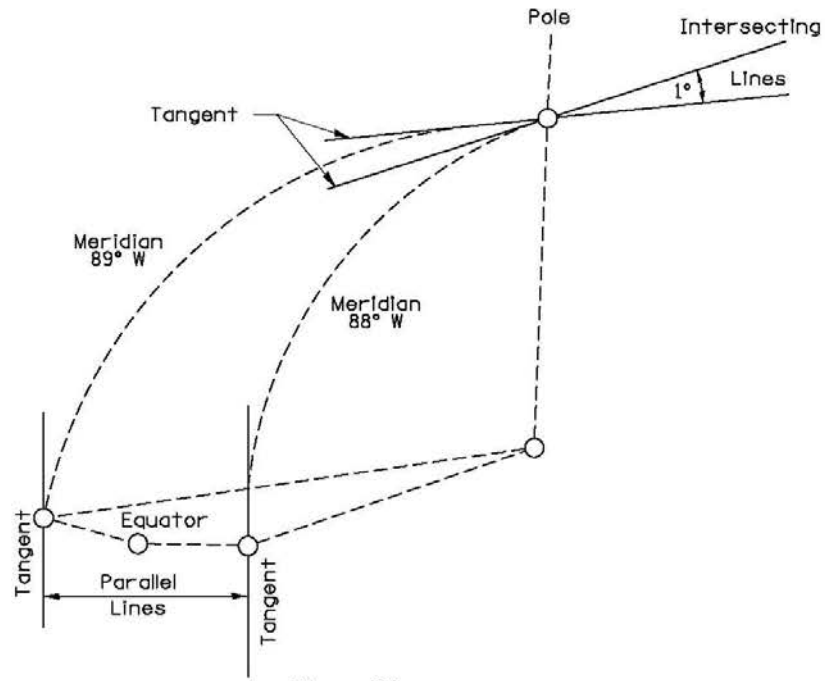

Figure C.1

Figure C.1

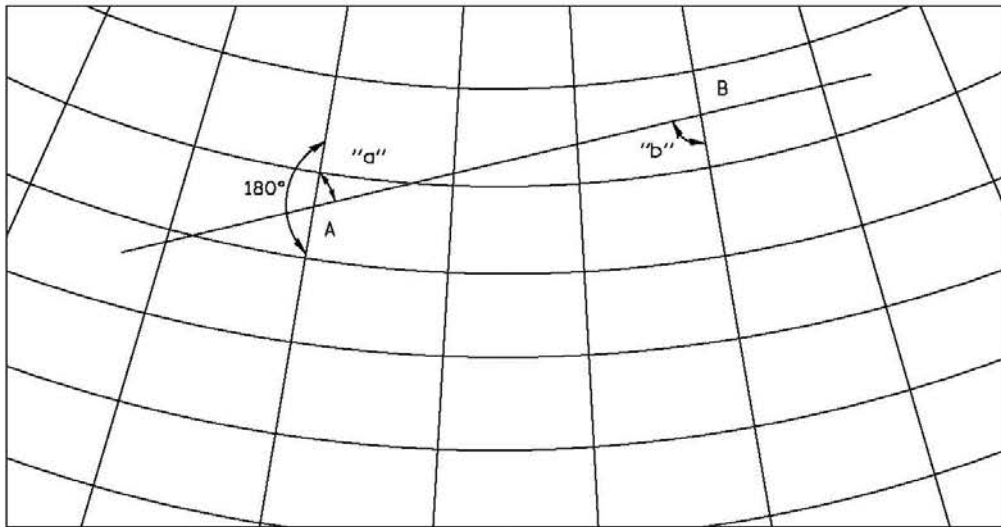

Figure C.2

Figure C.2

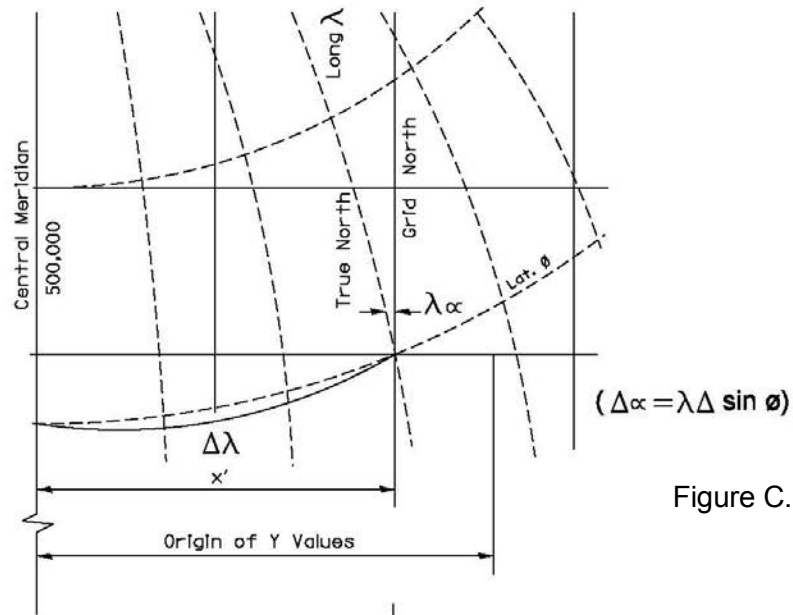

Figure C.3

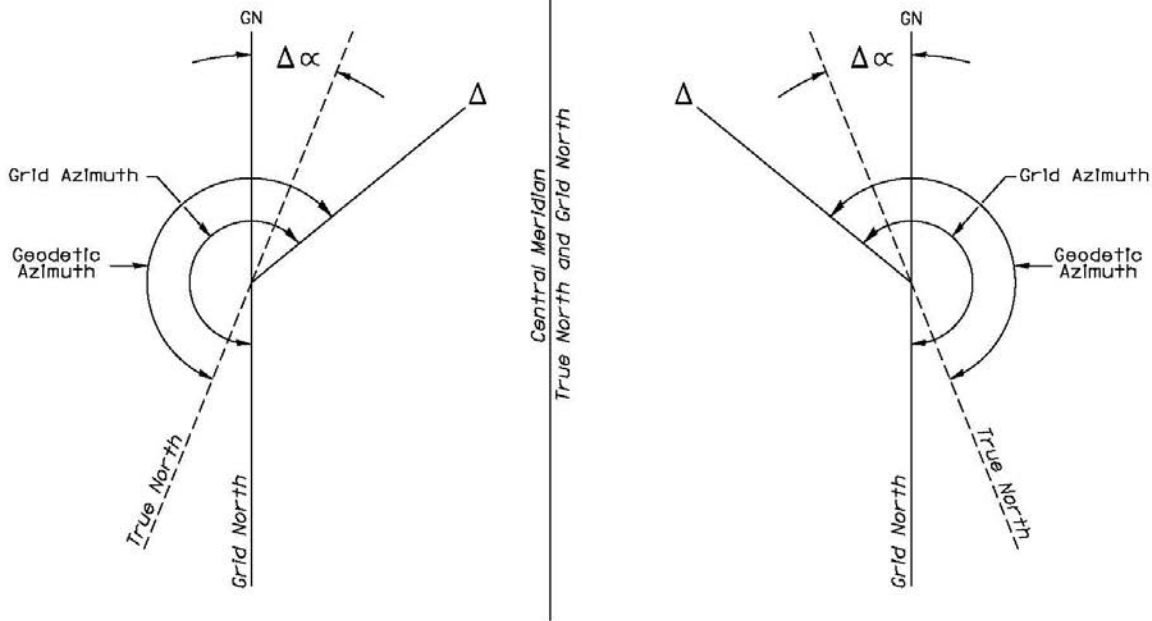

Figure C.4

VI. USING THE ILLINOIS STATE PLANE COORDINATE SYSTEM

The Illinois State Plane Coordinate System (ISPCS) is not something that is new to surveying.

The system has been in existence since 1933. It has become more common now because of the Global Positioning Systems (GPS) being used for acquiring horizontal and vertical positioning. You do not have to know anything about GPS to understand a state plane coordinate system. The GPS software provides state plane coordinates as part of the output from the observed data.

The system was developed to allow a surveyor to use a plane rectangular coordinate system while surveying on a curved surface. Prior to the development of the State Plane Coordinate System, geodetic positions given in latitudes and longitudes represented the only statewide coordinate system available to surveyors. To use such a geodetic system was very impractical. It required knowledge of the tedious and complicated procedure of geodetic surveying. Geodetic surveying involves performing computations on the surface of a spheroid. The development of the SPCS has made the very precise geodetic system available to local surveyors who can now use plane-rectangular survey methods to reference their surveys to the statewide system. The system provides the means to relate geodetic positions (latitude and longitude), which are referenced to an ellipsoid, to a plane grid system, which is much easier to work with.

The SPCS was developed in 1933 by the U.S. Coast & Geodetic Survey, now known as the National Geodetic Survey (NGS). A system was designed for each state of the union. Converting geodetic coordinates to state plane coordinates involves projecting survey measurements made on a curved surface onto a plane surface. In the United States two map projections are used. One is a cylinder and one is a cone. These projections allow the scale factor to be variable in only one direction, either east-west or north-south. This makes the system easier to use. The scale factor will be discussed in more detail later.

VII. PROJECTIONS

The projections used to transfer coordinates from geodetic to state plane are the Transverse Mercator and the Lambert Conformal.

A. TRANSVERSE MERCATOR

In the Transverse Mercator Projection, a cylinder rotated 90° to the axis of the Earth is used as a projection surface. As [Figure 2.1, page 2-21](#) of [Chapter Two](#) illustrates, a cylinder having a slightly smaller diameter than the ellipsoid is intersected with the ellipsoid. An ellipsoid is a mathematical figure that best represents the shape of the Earth. Measurements made on the Earth's surface are projected onto the cylinder's surface.

The Transverse Mercator projection is used for states that have long distances in a north-south direction. The north-south lines where the cylinder and the ellipsoid intersect are known as lines of equal scale. They are designed to be equidistant from the central meridian of the zone. Along the lines of equal scale, measurements on the ellipsoid and cylinder of projection are equal.

Illinois uses the Transverse Mercator Projection. To maintain a certain degree of accuracy, two different projections are used to cover Illinois. There is the East Zone and the West Zone. To avoid confusion, coordinates used or developed in a local survey must identify which zone was used. See [Figure C.5, page C-17](#).

A.1 East Zone

The East Zone was designed so that the Central Meridian of the Zone lies along longitude 88° 20' W. The origin of the Zone is at the intersection of latitude 36° 40' N and the Central Meridian. At the origin, the north coordinate is assigned a value of zero. The central meridian is assigned a value so there will never be any negative coordinates in the east-west direction for that zone. The accuracy of the East Zone is 1:40,000 at the Central Meridian. This is based upon the amount of linear distortion that is mathematically imposed upon ellipsoid distances when projected onto the plane surface at the central meridian of the zone.

A.2 West Zone

The West Zone was designed so the Central Meridian of the Zone lies along longitude 90° 10' W. The origin of the Zone is at the intersection of latitude 36° 40' N and the Central Meridian. At the origin, the north coordinate is assigned a value of zero. The central meridian is assigned a value so there will never be any negative coordinates in the east-west direction for that zone. The accuracy of the West Zone is 1:17,000 at the Central Meridian.

[Figure C.6, page C-18](#) shows the zone constants for the East and West Zones in Illinois.

B. LAMBERT CONFORMAL

The Lambert Conformal Projection is used for states with the longest distance being in an east-west direction. Here the projection surface is a cone. The lines of equal scale are lines of latitude. See [Figure 2.2, page 2-22 of Chapter Two](#). The scale factor does not change in an east-west direction, only in the north-south direction. [Figure C.7, page C-19](#) illustrates the type of projection used in each state.

VIII. DISTANCE REDUCTIONS

To establish coordinates on the state plane coordinate system, two corrections must be applied to the distance measurements. [Figure C.8, page C-20](#) provides an overview of reducing a distance from geodetic to grid or the plane surface. These corrections transfer the measurement from the ground surface to the plane surface. One correction is provided by the elevation factor (EF), which transfers the measured distance from the Earth's surface to the ellipsoid surface. The second correction is provided by the scale factor, which transfers the measured distance from the ellipsoid to the plane surface.

A. ELEVATION FACTOR FOR THE NORTH AMERICAN DATUM OF 1927 (NAD27)

The elevation factor is the ratio of the distance at mean sea level to the horizontal distance on the Earth's surface. See [Figure C.9, page C-21](#). Using similar triangles, the ratio is that of the Earth's radius to the Earth's radius plus the height above mean sea level. For the determination of the elevation factor, the Earth's radius is assigned a value of 20,906,000 feet. The exactness of this value is not critical when using a value of this size in a ratio. In the NAD27, the ellipsoid of reference was considered to be the same as mean sea level. Mean sea level is also referred to as the geoid. They are not exactly the same, but for lower-order surveys they are close enough to be considered the same. The Elevation Factor for use in computing NAD27 coordinates can be calculated by using the following equation:

$$EF = R / (R+h)$$

where:

h = Height above mean sea level

R = 20,906,000 feet

Example computation: Known Information
 h = 682.35 feet
 R = 20,906,000 feet

$$EF = 20,906,000 / (20,906,000 + 682.35) = 0.99996736$$

B. ELEVATION FACTOR FOR THE NORTH AMERICAN DATUM OF 1983 (NAD83)

In 1983, the National Geodetic Survey (NGS) performed a new adjustment of the horizontal control network in the United States. The elevation factor for NAD83 is calculated differently than for NAD27. The ellipsoid of reference has been redefined. In the NAD27 the Clarke's spheroid of 1866 was designed to best represent the Earth's shape across the coterminous United States. In the NAD83 the ellipsoid was redefined to best fit the entire Earth. The ellipsoid of reference for NAD83 is the Geodetic Reference System of 1980 (GRS80). [Figure C.10, page C-22](#) gives the formula for computing the elevation factor when using the NAD83 coordinate system. In this formula the separation (N) between the ellipsoid and mean sea level (geoid) must be accounted for. The value of N is given on the description sheets for stations having NAD83 coordinates. The value of N is always a negative value in Illinois because mean sea level is below the ellipsoid of reference as defined by GRS80. The Elevation Factor for NAD83 can be calculated by using the following equation:

$$EF = R / (R + N + H)$$

where: N = Geoid-Ellipsoid Separation
 H = Elevation
 R = 20,906,000 feet

Example computation: Known information
 H = 682.35 feet
 N = -105.754 feet

$$EF = 20,906,000 / (20,906,000 - 105.754 + 682.35) = 0.99997242$$

Normally, only one elevation factor is determined for a project. Determine an average elevation of the terrain and use it to determine the elevation factor.

C. SCALE FACTOR

The scale factor (SF) determination is the same for either the NAD27 or NAD83. That is because the definitions of the zones were not changed during the development of NAD83. The projections are the same. The equations to calculate the scale factor are not as simple as for the elevation factor. The NGS furnishes tables for determining the scale factor for a point or project. The interpolation is relatively easy to make to determine the scale factor for a particular project. See [Figures C.11](#) and [C.12](#) on Pages [C-23](#) and [C-24](#) for the scale factor tables for the East and West Zones in Illinois. The scale factor is based on the distance (X') that the point lies east or west of the central meridian of the zone. To obtain this distance (X'), calculate the difference between the east coordinate of the point and the east coordinate of the Central Meridian. The value of the central meridian is different in the NAD27 and NAD83 systems. For NAD27 the central meridian has a value of 500,000 feet for both zones. In NAD83 the value for the East Zone is 300,000 meters and for the West Zone it is set at 700,000 meters.

Following is an example computation of a scale factor for a point in the East Zone. The West Zone is calculated using the tables for the West Zone.

Known Information: The point has an east coordinate (X) of = 623,234.980 feet

$$X' = X - 500,000$$

$$X' = 623,234.98 - 500,000 = 123,234.98 \text{ feet}$$

From the table for the East Zone, the X' distance lies between an X' value of 120,000 and 125,000. From the table, the SF for 120,000 is 0.9999915 and for 125,000 it is 0.9999929. It is a matter of a simple interpolation to determine that the SF for 123,234.98 is = 0.9999924. Normally, only one scale factor is determined for a project. If a survey project is long (10 miles or more) in an east-west direction, the project should be divided up into smaller segments and a scale factor determined for each segment. The number of segments will depend upon the accuracy desired of the survey.

D. GRID FACTOR

Sometimes you will come across a value-labeled grid factor. This is not another separate factor that must be determined. It is a combination of the elevation factor and the scale

factor. For ease of computations the two factors are normally combined into one factor because both the elevation factor and the scale factor are applied to the distance measurements made on the surface of the Earth to convert them to a grid distance in the SPCS. The grid factor is computed by simply multiplying the two factors together.

IX. HORIZONTAL ANGLES IN THE STATE PLANE COORDINATE SYSTEM

A. HORIZONTAL ANGLE CORRECTION

So far we have been discussing how to convert the measured ground distances to grid distances for use in computing state plane coordinates. Because we are surveying on a curved surface, the horizontal angle measurements are somewhat distorted. The angles measured are not true horizontal angles because of the Earth's curvature. Corrections can be determined and applied to convert the measured angles to grid angles. But since the correction is so small, we do not normally calculate this correction unless we are performing first-order or better surveys. Lines-of-site must be over 5 miles in length before we even start to see the effects of this distortion due to the Earth's curvature. Therefore, the corrections to the horizontal angles will not be covered here.

B. CONVERGENCE ANGLE

The convergence angle is something that is important and needs to be addressed. In the geodetic coordinate system the lines of longitude all converge at the poles. Geodetic azimuths are referenced to these lines. In a rectangular coordinate system, like the Illinois State Plane Coordinate System, all north-south lines are parallel. Grid azimuths are referenced to these parallel lines. The central meridian is the only place where there is not a convergence angle. Here the grid north is the same direction as the line of longitude. Everywhere else there is a difference between the geodetic azimuth and the grid azimuth. This difference is called the convergence angle or mapping angle. The convergence angle can be calculated for a point by using the following equation:

$$\alpha'' = (\Delta\gamma'') \text{ sine } \phi^{\circ}$$

where:

- α'' = The mapping angle convergence expressed in seconds of arc.
- $\Delta\gamma''$ = The longitudinal difference, expressed in seconds of arc, between the central meridian and the point. Subtract the longitude of the point from the longitude of the central meridian.

It is the surface of reference for astronomical observations and for geodetic leveling.” (Definitions of Surveying and Associated Terms, ACSM 1972).

B. ELLIPSOIDAL HEIGHTS

These heights are referenced to the ellipsoid defined by the Geodetic Reference System of 1980 and not mean sea level or the geoid. Ellipsoidal heights are a direct output of the GPS because GPS uses the GRS 80 as its ellipsoid of reference.

C. GEOID-ELLIPSOID SEPARATION

The Clarke’s Spheroid of 1866 and the Geodetic Reference System of 1980 are two different mathematical figures. As mentioned earlier, the Clarke’s spheroid of 1866 provided a best fit ellipsoid for the coterminous United States, whereas the GRS80 is a best fit for the Earth. The difference between the two is called the geoid-ellipsoid separation.

See [Figure C.14, page C-26](#) for an illustration. In Illinois the ellipsoid is above the geoid. This separation must be taken into account when working with NAD83 coordinates.

XI. COMPUTING SURVEY TRAVERSES USING STATE PLANE COORDINATES

Computing a traverse to obtain state plane coordinates is basically the same as any other traverse computations. The azimuths of the courses must be calculated. Once the azimuths and distances are determined, then the latitudes and departures can be calculated, just as they are in a traverse where state plane coordinates are not used.

A. CALCULATING GRID AZIMUTH

To determine the grid azimuths of the courses of a traverse, a known azimuth must be observed and a horizontal angle measured from it to the first course of the traverse. Successive angles are then added to the previous azimuth to determine the azimuth for every course in the traverse. At the last point of the traverse, the horizontal angle must close onto a known azimuth to check the accuracy of the angle measurements. If the required accuracy is met for the survey, the angles are adjusted so the summation of the angles provides a perfect closure.

B. CALCULATING THE TRAVERSE

After calculating the grid azimuths and the grid distances, the latitudes and departures can be determined for each course. This part of the traverse computation follows the same procedures as for any other traverse. To obtain state plane coordinates for the traverse the beginning point of the traverse must have known coordinates from a previous survey.

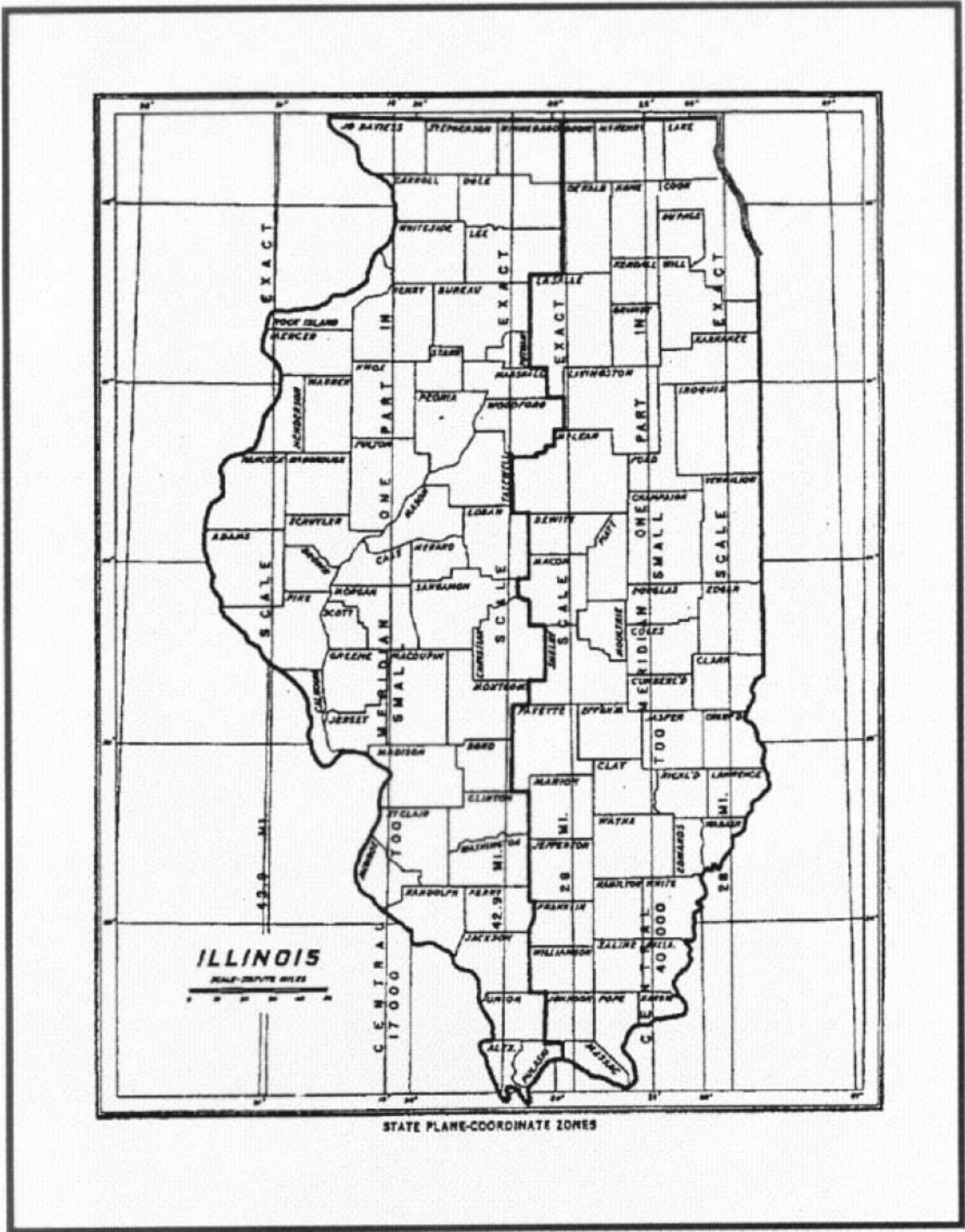

Figure C.5

Illinois State Plane Coordinate System Projection Constants

	NAD 27	NAD 83
East Zone (1201)		
Central Meridan =	88° 20'	88° 20'
Origin Longitude =	88° 20'	88° 20'
Origin Latitude =	36° 40'	36° 40'
Origin Easting =	500,000 ft	300,000 m (984,250 ft)
Origin Northing =	0 ft	0 ft
West Zone (1202)		
Central Meridan =	90° 10'	90° 10'
Origin Longitude =	90° 10'	90° 10'
Origin Latitude =	36° 40'	36° 40'
Origin Easting =	500,000 ft	700,000 m (2,296,583 ft)
Origin Northing =	0 ft	0 ft

Figure C.6

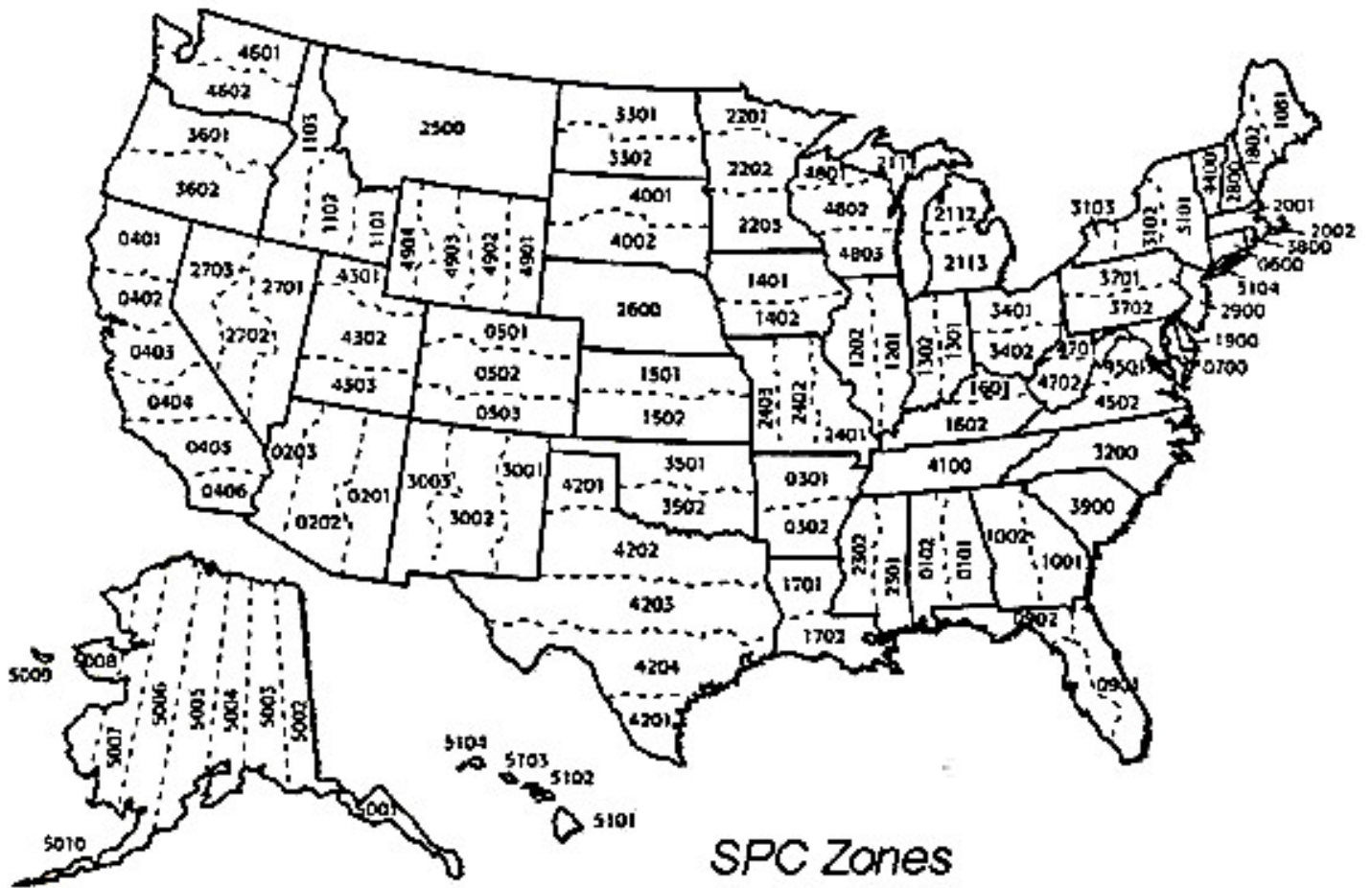
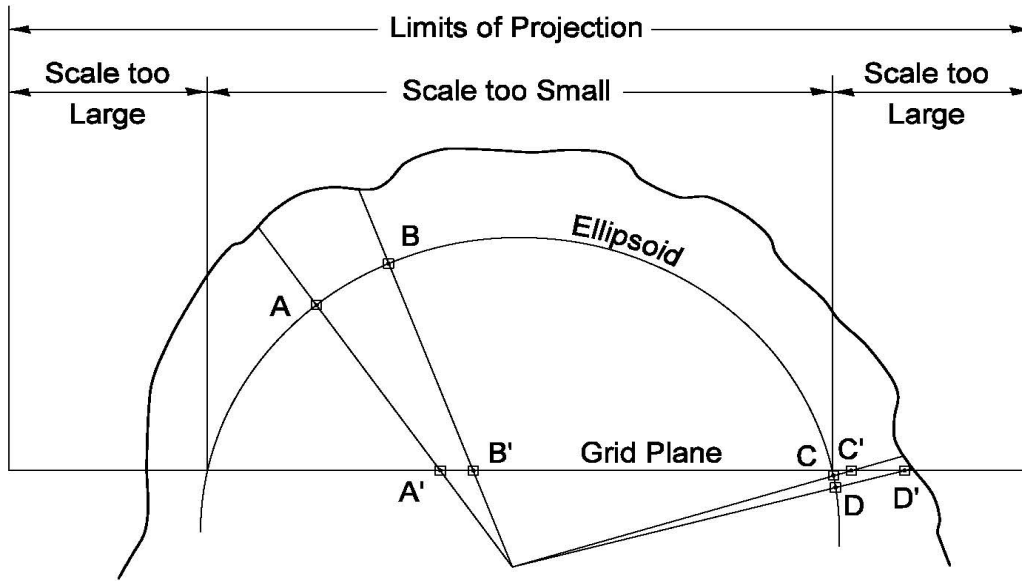

Figure C.7

Distance Reduction Geodetic to Grid



Grid Distance A' to B' is smaller than Geodetic distance A to B
Grid Distance C' to D' is larger than Geodetic distance C to D

Figure C.8

Reduction to Sea Level

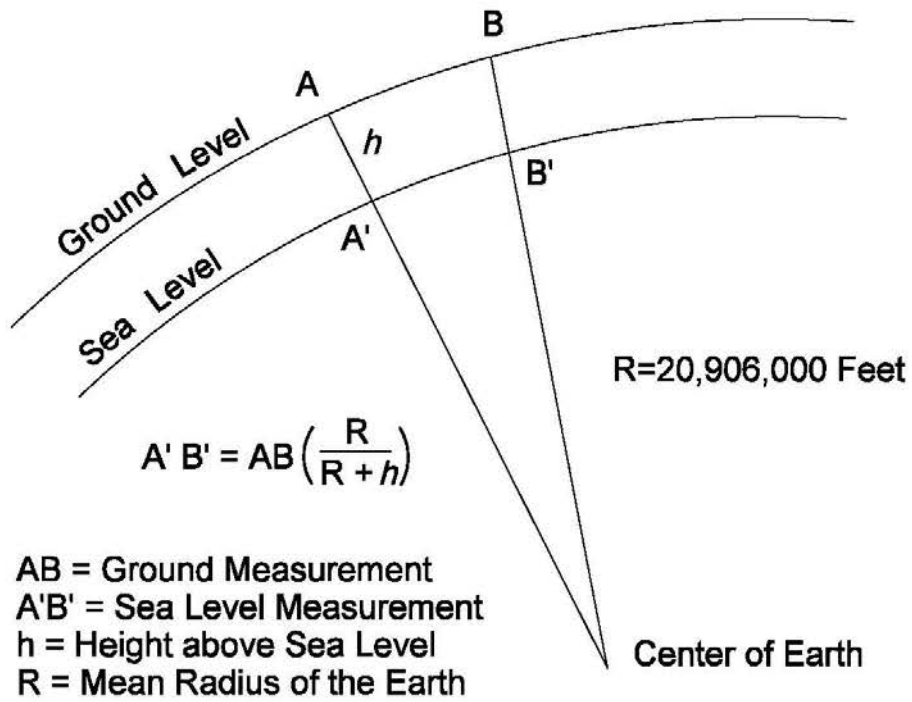

Figure C.9

Reduction to the Ellipsoid

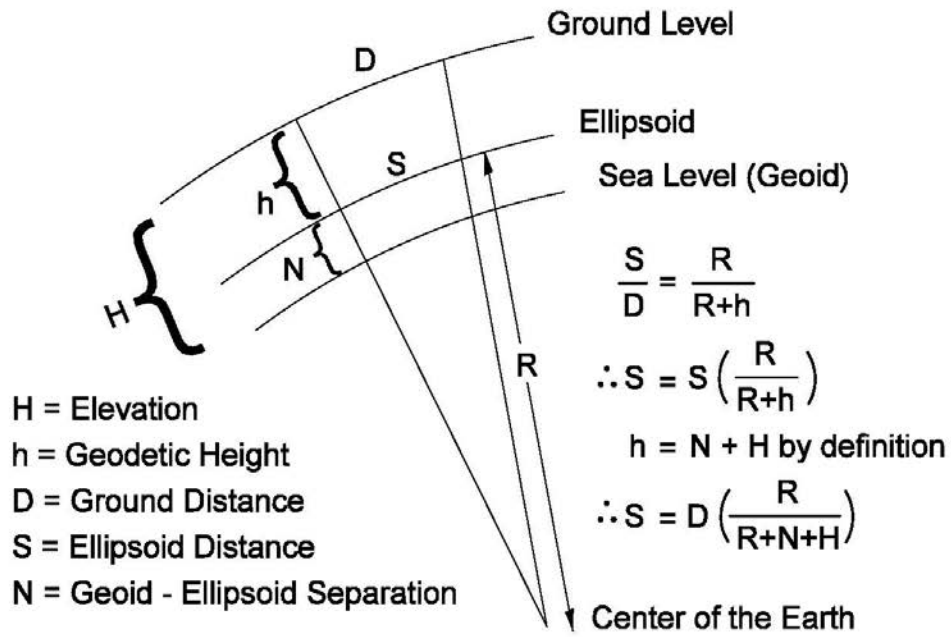

Figure C.10

TRANSVERSE MERCATOR PROJECTION

ILLINOIS

EAST ZONE

x' (feet)	Scale in units of 7th place of logs	Scale expressed as a ratio	x' (feet)	Scale in units of 7th place of logs	Scale expressed as a ratio
0	-108.6	0.9999750	175,000	+43.5	1.0000100
5,000	-108.5	0.9999750	180,000	+52.3	1.0000120
10,000	-108.1	0.9999751	185,000	+61.3	1.0000141
15,000	-107.5	0.9999752	190,000	+70.6	1.0000163
20,000	-106.6	0.9999755	195,000	+80.2	1.0000185
25,000	-105.5	0.9999757	200,000	+90.0	1.0000207
30,000	-104.1	0.9999760	205,000	+100.1	1.0000230
35,000	-102.5	0.9999764	210,000	+110.4	1.0000254
40,000	-100.7	0.9999768	215,000	+120.9	1.0000278
45,000	-98.5	0.9999773	220,000	+131.7	1.0000303
50,000	-96.2	0.9999778	225,000	+142.8	1.0000329
55,000	-93.6	0.9999784	230,000	+154.1	1.0000355
60,000	-90.7	0.9999791	235,000	+165.6	1.0000381
65,000	-87.6	0.9999798	240,000	+177.4	1.0000408
70,000	-84.3	0.9999806	245,000	+189.4	1.0000436
75,000	-80.7	0.9999814	250,000	+201.7	1.0000464
80,000	-76.8	0.9999823	255,000	+214.3	1.0000493
85,000	-72.7	0.9999833	260,000	+227.0	1.0000523
90,000	-68.4	0.9999843	265,000	+240.1	1.0000553
95,000	-63.8	0.9999853	270,000	+253.4	1.0000583
100,000	-58.9	0.9999864	275,000	+266.9	1.0000615
105,000	-53.9	0.9999876	280,000	+280.7	1.0000646
110,000	-48.5	0.9999888	285,000	+294.7	1.0000679
115,000	-42.9	0.9999901	290,000	+309.0	1.0000711
120,000	-37.1	0.9999915	295,000	+323.5	1.0000745
125,000	-31.0	0.9999929	300,000	+338.3	1.0000779
130,000	-24.7	0.9999943	305,000	+353.3	1.0000814
135,000	-18.1	0.9999958	310,000	+368.5	1.0000849
140,000	-11.3	0.9999974	315,000	+384.1	1.0000884
145,000	-4.2	0.9999990	320,000	+399.8	1.0000921
150,000	+3.1	1.0000007	325,000	+415.8	1.0000957
155,000	+10.7	1.0000025	330,000	+432.1	1.0000995
160,000	+18.5	1.0000043	335,000	+448.6	1.0001033
165,000	+26.6	1.0000061	340,000	+465.4	1.0001072
170,000	+34.9	1.0000080	345,000	+482.4	1.0001111
			350,000	+499.6	1.0001150

Figure C.11

TRANSVERSE MERCATOR PROJECTION

ILLINOIS

WEST ZONE

x' (feet)	Scale in units of 7th place of logs	Scale expressed as a ratio	x' (feet)	Scale in units of 7th place of logs	Scale expressed as a ratio
0	-255.5	0.9999412	175,000	-103.4	0.9999762
5,000	-255.4	0.9999412	180,000	-94.6	0.9999782
10,000	-255.0	0.9999413	185,000	-85.6	0.9999803
15,000	-254.4	0.9999414	190,000	-76.3	0.9999824
20,000	-253.5	0.9999416	195,000	-66.7	0.9999846
25,000	-252.4	0.9999419	200,000	-56.9	0.9999869
30,000	-251.0	0.9999422	205,000	-46.8	0.9999892
35,000	-249.4	0.9999426	210,000	-36.5	0.9999916
40,000	-247.5	0.9999430	215,000	-26.0	0.9999940
45,000	-245.4	0.9999435	220,000	-15.2	0.9999965
50,000	-243.1	0.9999440	225,000	-4.1	0.9999991
55,000	-240.5	0.9999446	230,000	+7.2	1.0000017
60,000	-237.6	0.9999453	235,000	+18.7	1.0000043
65,000	-234.5	0.9999460	240,000	+30.5	1.0000070
70,000	-231.2	0.9999468	245,000	+42.5	1.0000098
75,000	-227.6	0.9999476	250,000	+54.8	1.0000126
80,000	-223.7	0.9999485	255,000	+67.4	1.0000155
85,000	-219.6	0.9999494	260,000	+80.1	1.0000184
90,000	-215.3	0.9999504	265,000	+93.2	1.0000215
95,000	-210.7	0.9999515	270,000	+106.5	1.0000245
100,000	-205.8	0.9999526	275,000	+120.0	1.0000276
105,000	-200.7	0.9999538	280,000	+133.8	1.0000308
110,000	-195.4	0.9999550	285,000	+147.8	1.0000340
115,000	-189.8	0.9999563	290,000	+162.1	1.0000373
120,000	-184.0	0.9999576	295,000	+176.6	1.0000407
125,000	-177.9	0.9999590	300,000	+191.4	1.0000441
130,000	-171.6	0.9999605	305,000	+206.4	1.0000475
135,000	-165.0	0.9999620	310,000	+221.6	1.0000510
140,000	-158.2	0.9999636	315,000	+237.2	1.0000546
145,000	-151.1	0.9999652	320,000	+252.9	1.0000582
150,000	-143.8	0.9999669	325,000	+268.9	1.0000619
155,000	-136.2	0.9999686	330,000	+285.2	1.0000657
160,000	-128.4	0.9999704	335,000	+301.7	1.0000695
165,000	-120.3	0.9999723	340,000	+318.5	1.0000733
170,000	-112.0	0.9999742	345,000	+335.5	1.0000772

Figure C.12

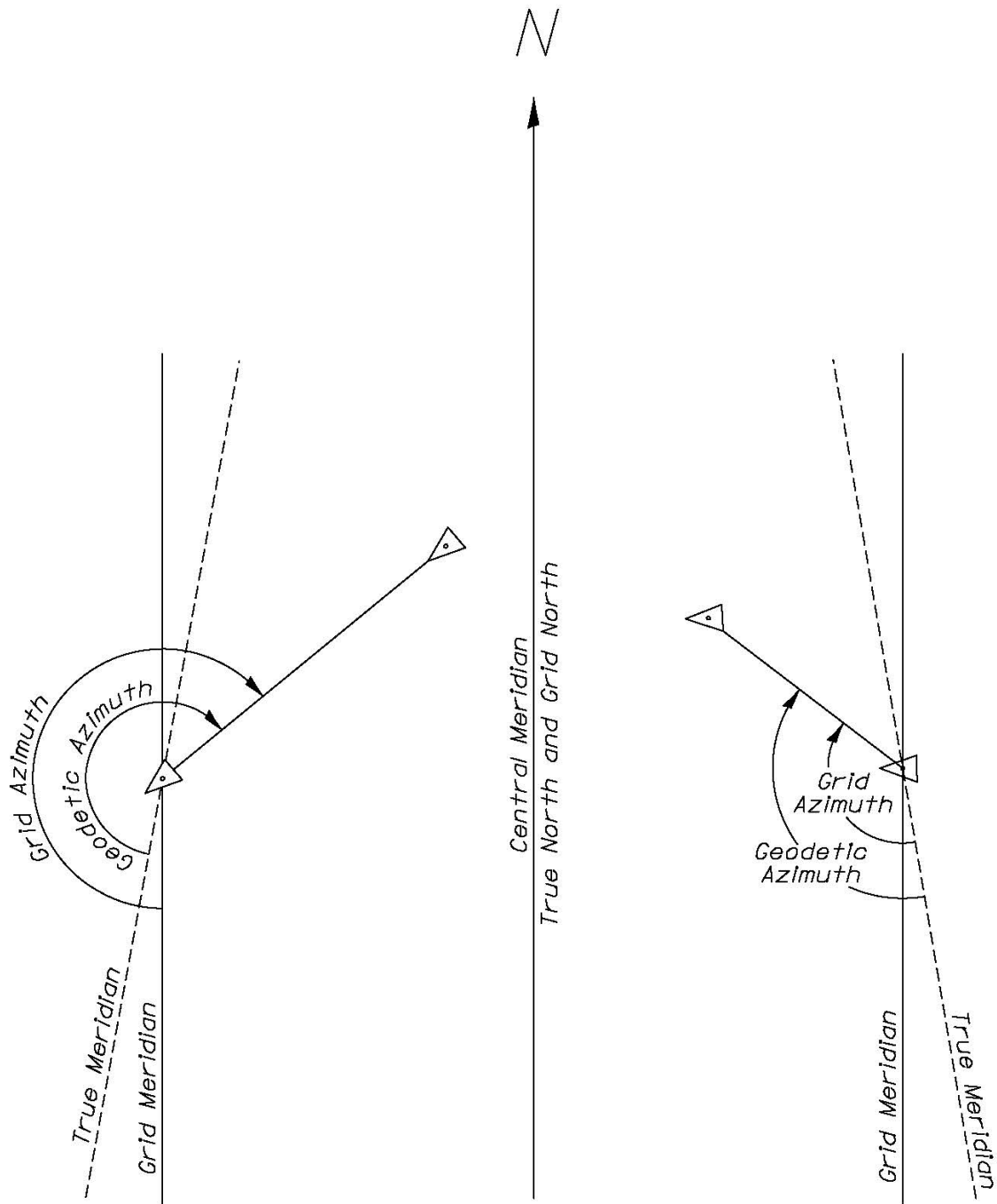

GEODETIC AND GRID AZIMUTH

Figure C.13

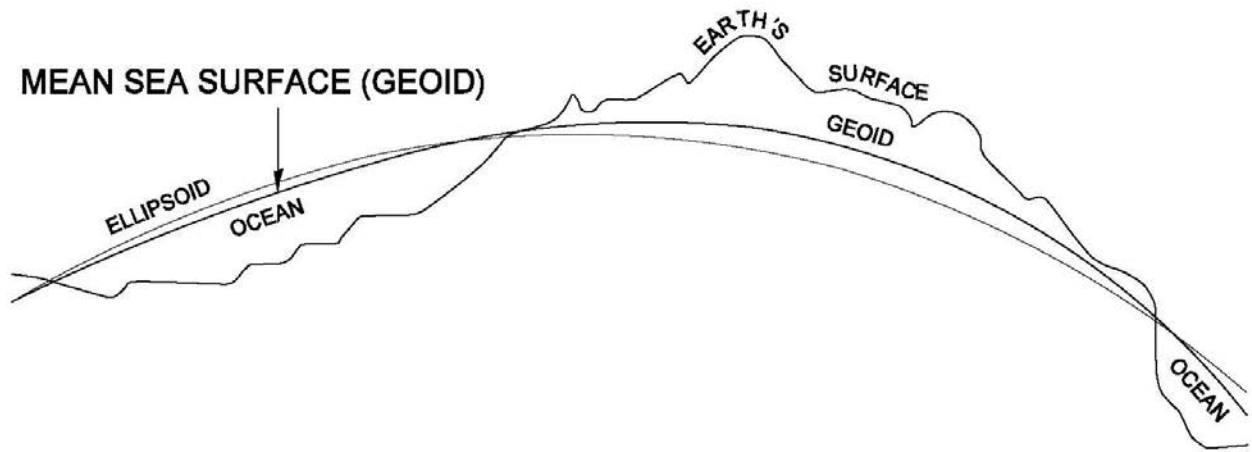

Geoid - Ellipsoid Surface Relationships

Figure C.14

APPENDIX D
CONFINED SPACE POLICY

BUREAU OF DESIGN AND ENVIRONMENT
SURVEY MANUAL

May 2015

APPENDIX D

CONFINED SPACE POLICY

Table of Contents

	Page
I. INTRODUCTION.....	D-1
II. SAFETY POLICY—CONFINED SPACE	D-3
III. EMPLOYEE SAFETY RESPONSIBILITIES	D-4
IV. PRE-ENTRY CERTIFICATION.....	D-4
V. SAFETY PROCEDURES.....	D-4
A. Setting Up the Vehicles in Traffic for Access to a Confined Space	D-4
B. Testing Confined Space Atmosphere	D-5
C. Communication/Inventory	D-6
D. Confined Space Ventilation	D-6
E. Lowering Equipment.....	D-7
F. Hazardous Situations.....	D-7
G. Fall Protection	D-8
H. Fall Arresting Systems	D-8
I. Confined Space Entry Equipment.....	D-8
J. Training	D-9
K. Emergency Response Plan.....	D-9
L. Hazardous Warning.....	D-10
VI. PRE-ENTRY CERTIFICATION REPORT	D-11
VII. INSTRUCTIONS FOR PRE-ENTRY CERTIFICATION REPORT	D-12

I. INTRODUCTION

Confined space entry is regulated by [OSHA under regulation 29 CFR 1910.146](#). OSHA defines a confined space as: large enough and so configured that an employee can bodily enter and perform assigned work and has limited or restricted means for entry or exit and is not designated for continuous human occupancy. A permit-required confined space (permit space) means a confined space that has one or more of the following characteristics:

1. Contains or has the potential to contain a hazardous atmosphere.
2. Contains a material that has the potential for engulfing an entrant.
3. Has a configuration such that the entrant could be trapped or asphyxiated by inwardly converging walls or by a floor which slopes downward and tapers to a smaller cross-section.
4. Contains any other recognized safety or health hazard.

One of the most potentially hazardous situations in highway operations is entry into a confined space. The following are some types of confined spaces, but the list is not all-inclusive: manholes, sewers, pipes, lift stations, some bridge superstructures, sub structures, coffer dams, underground utility vaults, wet wells, and storage tanks. The hazard is that the atmosphere being entered can be contaminated with either flammable or toxic gases, or be deficient in oxygen. While this work procedure deals with a planned entry, the sections on atmosphere testing and use of self-contained breathing apparatus will be helpful for emergency entry into a confined space. Dangerous contaminants sometimes found in confined spaces may be grouped as follows:

1. Fuel gases—such as manufactured gas, natural gas, or liquefied petroleum gases.
2. Vapors of liquid fuels and solvents—such as naphtha, gasoline, kerosene, benzene, and other hydrocarbons.
3. Gases from fermentation of organic matter—such as methane, carbon dioxide, hydrogen, hydrogen sulfide, and mixtures deficient in oxygen.

4. Products of combustion—such as carbon dioxide or carbon monoxide from engine exhaust.
5. Gases and volatile substances within industrial drainage.
6. Gases formed after sewer explosions and fires.
7. Gases from the use of nitro explosives.

Because mixtures of these contaminants are not uncommon, explosion, fire, and asphyxiation hazards may all be encountered in the same confined space. Hazardous atmospheres encountered underground can, therefore, be classified as flammable, poisonous, or suffocating.

The explosion hazard of flammable gases is generally understood. However, it is important to keep in mind that such gases are combustible throughout a range of air mixtures, which start at the lower explosive (flammable) limit (LEL) with just enough gas present to support combustion and range upward to the upper explosive (flammable) limit (UEL), above which there is no longer enough air for combustion.

This LEL-UEL range (in percent by volume) varies with the gas, and those having a wide range, such as hydrogen, are the most hazardous. Because the usual portable combustible gas indicators do not differentiate between gases—they indicate only relative combustibility and show how the sample compares with a suitable standard—the precautions described here pertain to all flammable gases.

Poisonous gases, some of which have no odor, can be fatal in very low concentrations in air. Carbon monoxide can be fatal at 1/10 of one percent, and it is dangerous at even 1/50 of one percent, because it accumulates in the body with continued exposure. Certain types of poisonous gases, such as hydrogen sulfide, have paralyzing effects on the sense of smell after initial exposure. This makes fatal concentrations undetectable by their odor. Therefore, prescribed testing methods are the only safe precaution.

The presence of suffocation gases or vapors may result in oxygen deficiency—a concentration below the minimum necessary to support life. Normal air has 21 percent oxygen. Although 16 percent is considered the minimum concentration of oxygen to support life, OSHA has established 19.5 percent as the safe minimum concentration for working in confined space.

Although there are gases that are lighter than air, many vapors are heavier, such as butane, propane, and other hydrocarbons. Such gases remain in ground depressions and flow into low points such as underground structures, where they create a hazard that is difficult to remove. Other gases, generated by decaying vegetation or animal matter, find their way into manholes. Such gases are usually high in carbon dioxide, low in oxygen, and contain varying amounts of methane. Some, like hydrogen sulfide, may become combustible when more air is introduced to form a combustible mixture. They are dangerous primarily because they lack sufficient oxygen to support life. Oxygen deficiency may also be caused by oxidation of metals or other materials in damp, enclosed areas, or by the dilution or displacement of air by other gases.

II. SAFETY POLICY—CONFINED SPACE

The Illinois Department of Transportation recognizes that a program for safe working conditions has to be a partnership arrangement between management and employees. Management's responsibility is to be aware of all known safety hazards and to provide employees with suitable safety equipment and training. Each employee must also be committed to personal and co-worker safety. IDOT management will require each employee to observe and practice the safety procedures as instructed. Safety only works if it is practiced day-in and day-out by all parties concerned.

Each District/Bureau performing work in or around a confined space shall assign a person to serve as a Confined Space Coordinator. This person shall be responsible for maintaining a central point for all records relating to confined space training, confined space inventories, and confined space entry permits. This person shall be qualified and competent in confined space entries.

The Department will identify known or potential confined spaces for each locality that may be encountered by employees. The confined spaces will be documented in a Department Confined Space Inventory. The inventory will be updated every year.

If employees are not to enter and work in permit spaces, employers must take effective measure to prevent them from entering these spaces. If employees are expected to enter permit spaces, the employer must develop a written permit space program and make it available to employees or their representatives.

All confined spaces that are categorized as a permit-required confined space will be documented and posted to inform employees of the existence of such a space by posting a warning sign which reads:

DANGER--Permit-Required Confined Space--DO NOT ENTER

III. EMPLOYEE SAFETY RESPONSIBILITIES

- A. Follow all safety rules and regulations established for the job.
- B. Wear proper safety equipment required for the job.
- C. Report all unsafe conditions to the supervisor.
- D. Report all injuries.
- E. Inform all workers of any current or potential hazards.
- F. If the entry into a confined space is questionable at any time from a safety standpoint, notify the supervisor immediately. Do not enter a confined space that is not safe.

IV. PRE-ENTRY CERTIFICATION

Once a problem is encountered in a confined space, it is quite likely that the problem will persist in the future. Therefore, it is good to have knowledge of those confined spaces that have had hazardous atmospheres.

Prior to making an entry into a confined space, a pre-entry certification report shall be completed. The permit shall give the location of the confined space, reason for entering, names of workers involved, and results of atmosphere testing. The permit shall be given to your supervisor. See example permit form on [page D-11](#).

V. SAFETY PROCEDURES

- A. SETTING UP THE VEHICLES IN TRAFFIC FOR ACCESS TO A CONFINED SPACE

When required before positioning vehicle, be sure to follow all current traffic control policy.

- a) Everyone must be wearing hard hats, orange vests, approved steel-toed shoes, and additional required personal protection equipment as determined by the competent person.
- b) Extinguish all cigarettes. No smoking while positioning equipment, or in general area.

B. TESTING CONFINED SPACE ATMOSPHERE

Before workers are allowed to open and enter manhole structures or other confined spaces, the structures/spaces shall first be tested for oxygen concentrations, flammable and non-flammable gases, toxic vapors, hydrogen sulfide, and other potential hazardous atmospheric conditions that reasonably may exist. The test results shall be used to determine ventilation and respiratory protection requirements. Sound testing procedures must be utilized.

All confined spaces shall be power ventilated at all times when people are in the confined space.

All personnel entering a manhole or other confined space shall wear appropriate Class III safety harness and life lines for quick removal in case of an emergency. The safety harness and life lines shall be so attached that the body cannot be jammed in an exit opening. At least two (one of which shall be the attendant and the other nearby) workers shall remain on the surface in such a position that they can observe and assist in the removal of those in the manhole. A hoisting and/or retrieval device will be in place at all such locations.

Employees entering the confined space shall wear the gas/oxygen monitoring equipment and continuously monitor the atmosphere during the entire time they are in the confined space. If the gas monitor indicates an unsafe atmosphere, vacate the space immediately, contact your supervisor, take steps to ventilate the confined space, identify source of the problem, and do not re-enter the space until the atmosphere is clear.

C. COMMUNICATION/INVENTORY

Communications (visual, voice, or signal line) shall be maintained between both, or all, individuals present.

Each district shall maintain a current inventory of the following:

- Confined space types.
- Confined space equipment, including ventilatory, hoist, winch, harness, lanyards, tripods, testing equipment, and rescue equipment.

D. CONFINED SPACE VENTILATION

Even when all atmosphere tests are within allowable limits, the confined space shall be purged with a power blower with a fresh supply of air for at least five (5) changes of air and continuously ventilated with a powered ventilator while employees are in the confined space.

The atmosphere shall be continuously monitored while it is occupied by employees.

If gases are found, or an oxygen deficiency exists, the following procedures shall be implemented:

(a) For oxygen deficiency, ventilate for five (5) air changes and complete a new series of atmosphere tests again. **Do not enter an atmosphere that tests below 19.5% oxygen by volume.** If you cannot get a safe (19.5%) reading, close the space and contact your supervisor. Fifteen minutes shall be the minimum ventilation time.

(b) If gases are detected, purge the confined space until you get a zero reading. You shall continuously monitor the atmosphere. At any time the concentrations exceed 20% LEL, cease operations, and vacate the space. Close the space and advise the supervisor.

Blowers should be located so there are no unnecessary bends in the hose. One 90-degree bend reduces the blower capacity to 70% of rated capacity. Two 90-degree bends reduce capacity to 50% or 1/2. Three 90-degree bends reduce to 1/3 of capacity.

Each additional hose length to equal one 90-degree bend. When the output of the blower capacity is reduced to below 300 CFM, a larger or additional blower should be used. For continuous ventilation with people in a manhole, a blower of at least 500 CFM shall be used. Gas and oxygen tests shall be made continuously, no matter how "clean" the confined space seems to be. Blowers shall be located so they will not pick up exhaust gases from vehicles, heaters, furnaces, or the blower engine. They shall not ingest fuel vapors, e.g., gasoline, propane, etc. The blowers should operate for 1 minute to flush out the hose, prior to placing it in the manhole. Air should be tempered from temperature extremes. The blowers shall meet National Fire Protection Association (NFPA) requirements to prevent ignition hazard.

E. LOWERING EQUIPMENT

1. Never drop anything down.
2. Lower small items in a bucket.
3. Large items such as hoses and crowbars must be securely tied before lowering.
4. Always announce before lowering anything.
5. The person below should never look up while something is being lowered.
6. Stand to one side of the confined space and reach above to grab lowered items.

F. HAZARDOUS SITUATIONS

Under hazardous conditions, employees working in confined spaces shall wear life lines, and at least two workers should be positioned at the surface where they can see or hear those in the confined space. An emergency rescue plan must be in place. They should also be properly equipped with hoisting equipment and trained to render assistance in case of an emergency.

If the worker in the confined space loses consciousness, the emergency rescue plan must be initiated immediately. Remove the unconscious worker as quickly as possible.

If the observer must enter the confined space, the observer shall use a self-contained breathing apparatus. Do not try to give the unconscious worker air from your breathing apparatus. If a spare breathing apparatus is available, use it.

G. FALL PROTECTION

Where a potential exists for persons or objects falling into a confined space, warning systems or barricades shall be employed at the entrance.

H. FALL ARRESTING SYSTEMS

Fall arresting systems shall be worn by personnel entering confined spaces as determined by a qualified person.

I. CONFINED SPACE ENTRY EQUIPMENT

The following is a list mandating equipment that shall be available at the confined space:

1. Atmosphere tester (flammability, toxicity, hydrogen sulfide, and oxygen) calibrated at least every six months and at least annually by certified personnel.
2. Self-contained breathing apparatus.
3. Full-body harness.
4. Hoist.
5. Hard hat.
6. Rope (life line).
7. Ventilator/Blower.
8. Tripods.

J. TRAINING

General requirements: Personnel responsible for supervising, planning, entering, or participating in confined space entry and rescue shall be adequately trained annually in their functional duties prior to any confined space entry.

Training shall include:

- An explanation of the general hazards associated with confined spaces.
- A discussion of specific confined space hazards associated with the facility, location, or operation.
- The reason for, proper use, and limitations of personal protective equipment and other safety equipment required for entry into confined spaces.

All personnel required to work/or enter a confined space shall be trained in the Department's Policy and Emergency Procedures.

K. EMERGENCY RESPONSE PLAN

A plan of action shall be written with provisions to conduct a timely rescue for individuals in a confined space should an emergency arise. Included in these provisions shall be:

- An outside attendant who is trained in confined space entry, CPR, and First Aid.
- The outside attendant is the first line of rescue for confined space entries.
- Determination of what methods of rescue must be implemented to retrieve individuals.
- Designation of rescue personnel that are immediately available where confined space entries are conducted.
- Type and availability of equipment needed to rescue individuals.

- An effective means to summon rescuers in a timely manner.
- Hands-on training and drill of the attendant and rescue personnel in preplanning, rescue, and emergency procedures annually.

Breathing equipment: All rescue personnel must use self-contained breathing apparatus/SCBA breathing equipment, when entering the confined space to rescue victims.

- If it is established that the cause of the emergency is not a hazardous atmosphere, rescue breathing equipment is not required.

Rescue equipment inspection: All rescue equipment shall be inspected periodically by a qualified person and prior to start of work to ensure that it is operable.

L. HAZARDOUS WARNING

1. Contractors. Bureaus that use contractors to enter confined spaces shall inform contractors of known potential hazards associated with the confined space to be entered.
2. Identification of rescue responder. The Bureau and contractor shall establish who will serve as the rescue responder in an emergency and what systems will be used to notify the responder that an emergency exists.

These are the minimum recommended requirements. Additional needs should be developed by local management to meet local needs and comply with appropriate Illinois Department of Labor Standards. All personnel that may be required to use a SCBA shall meet and comply with IDOT respirator policy.

Variances to this policy will be evaluated by the Employee Safety Unit on an individual basis upon receipt of a written report.

VI. PRE-ENTRY CERTIFICATION REPORT

Report is required for entering any confined space for any purpose prior to entry:

Date: _____ Time _____ am/pm

Location: _____

Equipment: _____

Purpose: _____

Employees entering confined space:

- 1. _____ 2. _____
- 3. _____ 4. _____

Stand-by Observers: 1. _____
 2. _____

1. Atmosphere tested for flammable concentration:

Time: _____ By: _____ (init)

2. Test for toxic atmosphere: ppm of: Time: _____ By: _____ (init)

3. Test for oxygen content: Reading: _____ % By: _____ (init)

4. Surrounding area checked for flammability and toxic gases:

Time: _____ By: _____ (init)

5. If a hazardous condition was encountered, what did you do to remove or compensate for the condition?:

6. Recommended improvements for safety:

Approved by: _____ (qualified person)

VII. INSTRUCTIONS FOR PRE-ENTRY CERTIFICATION REPORT

The Pre-Entry Certification Report shall be completed in duplicate by a qualified person immediately prior to entry into the confined space. The original shall be kept at the worksite while the work is being conducted. Following completion of the work or expiration of this report, the original shall be kept on file with the unit performing the work and a copy kept on file with the District's safety and health liaison.

The Pre-Entry Certification Report shall only be valid from the time the confined space is entered until it is closed, but shall not exceed 7.5 hours or one work shift.

For the most recent information on the Department's Safety Code, see <http://www.ediillinois.org/ppa/docs/00/00/00/03/47/52/EmployeeSafetyCode2010.pdf>.

APPENDIX E

SURVEY POINT CODES

The most accurate expression of Point Codes is maintained in the CADD Roadway and Structure Project Deliverables Policy (see Section 2.5), found online at:

<http://www.dot.state.il.us/Assets/uploads/files/Doing-Business/Manuals-Guides-&-Handbooks/Highways/Bridges/CADD/CADD%20Roadway%20and%20Structure%20Project%20Deliverables%20Policy.pdf>

BUREAU OF DESIGN AND ENVIRONMENT

SURVEY MANUAL

May 2015